

SKEIN LASAGNA MODULES AND HANDLE DECOMPOSITIONS

CIPRIAN MANOLESCU, KEVIN WALKER, AND PAUL WEDRICH

ABSTRACT. The skein lasagna module is an extension of Khovanov–Rozansky homology to the setting of a four-manifold and a link in its boundary. This invariant plays the role of the Hilbert space of an associated fully extended $(4 + \epsilon)$ -dimensional TQFT. We give a general procedure for expressing the skein lasagna module in terms of a handle decomposition for the four-manifold. We use this to calculate a few examples, and show that the skein lasagna module can sometimes be locally infinite dimensional.

1. INTRODUCTION

Homological invariants such as Khovanov homology [17] and Khovanov–Rozansky homology [21] are at the center of modern knot theory. These invariants were originally defined for links in \mathbb{R}^3 . Extending them to links in arbitrary 3-manifolds is a problem that garnered much attention recently, from various perspectives (categorification at roots of unity [20, 9, 28], theoretical physics [34, 14, 13], etc.)

One such extension was introduced in [27], based on higher category theory and using the concept of blob homology [26]. Given a smooth, oriented, compact four-manifold W and a framed oriented link L in the boundary ∂W , the construction in [27] associates to the pair (W, L) a homology theory graded by $\mathbb{Z}^3 \times H_2(W, L; \mathbb{Z})$ and denoted $\mathcal{S}_*^N(W; L)$. One of the three integer gradings is called the blob degree, and for our purposes we will focus on the theory in blob degree zero, $\mathcal{S}_0^N(W, L)$. This is called the *skein lasagna module* of (W, L) and has a relatively simple definition, reminiscent of the definition of the skein module of a 3-manifold. The skein lasagna module is defined as the span of the *lasagna fillings* of W with boundary L , modulo an equivalence relation. The lasagna fillings are certain decorated surfaces connecting L to other links in the boundaries of 4-balls inside W , and the equivalences come from cobordism maps in Khovanov–Rozansky homology.

Skein lasagna modules are challenging to compute. It was proved in [27] that when $W = B^4$, the invariant $\mathcal{S}_0^N(B^4; L)$ coincides with the Khovanov–Rozansky homology of the link L . Further computational methods were developed in [25], with a focus on 2-handlebodies (four-manifolds obtained from B^4 by attaching 2-handles). This allowed the calculation of the skein lasagna modules (in some gradings) for four-manifolds such as the complex projective plane, and disk bundles over S^2 .

In this paper, building on the work in [27] and [25], we give a new formula for the skein lasagna module of a link in the boundary of an arbitrary four-manifold. We start by choosing a handle decomposition for the four-manifold. For simplicity, we may assume that we have a single 0-handle. We then study how the skein lasagna module changes under adding handles. Disjoint unions, 4-handles and many cases of 2-handles were already studied in [25], so the main thing left is to understand 1- and 3-handles.

With regard to 3-handles, we have the following:

Theorem 1.1. *Suppose that we have a four-manifold W with boundary Y , and let W' be the result of attaching a 3-handle to W along a sphere $S \subset Y$. Let also L be a framed link in Y disjoint from*

CM was supported by NSF Grant DMS-2003488 and a Simons Investigator Award.

PW acknowledges support by the Deutsche Forschungsgemeinschaft (DFG, German Research Foundation) under Germany's Excellence Strategy - EXC 2121 "Quantum Universe" - 390833306.

S , and L' the corresponding link in $\partial W'$. The equator J of S splits the sphere into two hemispheres, each of which induces a cobordism map from $\mathcal{S}_0^N(W; L \cup J)$ to $\mathcal{S}_0^N(W; L)$. Then, the skein lasagna module $\mathcal{S}_0^N(W'; L')$ is isomorphic to the coequalizer of these two cobordism maps. (See Theorem 3.7 for a more precise statement.)

Next, we combine Theorem 1.1 with the treatment of 2-handles in [25] to get a general result, reducing the calculation of the skein lasagna module to the case of 1-handles.

Recall that in [25], the skein lasagna module of a 2-handlebody was shown to be isomorphic to the so-called *cabled Khovanov-Rozansky* of the attaching link for the 2-handles; this is obtained from the Khovanov-Rozansky homologies of the cables of this attaching link, modulo certain cobordism relations. We define an analogue of the cabled Khovanov-Rozansky homology for two links K, L in the boundary of $W_1 = \natural^m(S^1 \times B^3)$ (and, more generally, any other four-manifold); we call this the *cabled skein lasagna module* $\underline{\mathcal{S}}_0^N(W_1; K, L)$.

Theorem 1.2. *Consider four-manifolds $W_1 \subseteq W_2 \subseteq W_3 \subseteq W_4$ where*

- $W_1 = \natural^m(S^1 \times B^3)$ is the union of m one-handles;
- W_2 is obtained from W_1 by attaching n two-handles along a framed link K ;
- W_3 is obtained from W_2 by attaching p three-handles along spheres S_1, \dots, S_p ;
- W_4 be obtained from W_3 by attaching some four-handles.

Consider also a framed link $L \subset \partial W_4$, and view $K \cup L$ as a link in ∂W_1 . Then, the skein lasagna module $\mathcal{S}_0^N(W_4; L)$ is isomorphic to the quotient of the cabled skein lasagna module $\underline{\mathcal{S}}_0^N(W_1; K, L)$ by coequalizing relations coming from the 3-handles as in Theorem 1.1. (See Theorem 3.10 for a more precise statement.)

The cabled skein lasagna module $\underline{\mathcal{S}}_0^N(W_1; K, L)$ is constructed from the invariants $\mathcal{S}_0^N(W_1; K(a, b) \cup L)$ where $K(a, b) \cup L$ is a family of framed links in $\partial W_1 = \#^m(S^1 \times S^2)$ consisting of L and cables $K(a, b)$ of the attaching link K for the 2-handles. Thus, Theorem 1.2 allows us to express $\mathcal{S}_0^N(W_4; L)$ in terms of skein lasagna modules of links in ∂W_1 (and maps between them).

The second half of our paper studies in more detail the skein lasagna modules for links in ∂W_1 where $W_1 = \natural^m(S^1 \times B^3)$. We work with coefficients in a field \mathbb{k} . By cutting along the cocores of the 1-handles, we reduce the problem of computing $\mathcal{S}_0^N(W_1; L, \mathbb{k})$ to a problem about skein lasagna modules for the (boundary of the) 0-handle B^4 with a family of framed links related to L . For links in B^4 , the invariant \mathcal{S}_0^N is simply the Khovanov-Rozansky homology KhR_N .

Theorem 1.3. *Let $W_1 = \natural^m(S^1 \times B^3)$ with a nullhomologous link $L \subset \partial W_1$ in the boundary that intersects the belt spheres of the 1-handles transversely in $2p_i$ points for $1 \leq i \leq m$. Let $R \subset S^3 \setminus \bigsqcup_i (B_i \cup \bar{B}_i)$ denote the tangle obtained from L by cutting open along the belt spheres. Then, the skein lasagna module $\mathcal{S}_0^N(W_1; L, \mathbb{k})$ is isomorphic to the quotient*

$$\bigoplus_{\substack{\text{tangles } T_i \\ |\partial T_i|=2p_i}} \text{KhR}_N(R \cup \bigsqcup_i (T_i \sqcup \bar{T}_i), \mathbb{k}) \{(\sum_i p_i)(N-1)\} / \sim$$

where $\{\cdot\}$ denotes a grading shift, and the relation \sim is given by taking coinvariants for the actions of certain categories $\mathcal{S}_0^N(B^3; P_{p_i})$ associated to the configurations P_{p_i} of p_i positively oriented and p_i negatively oriented points in $S^2 = \partial B^3$. (See Theorem 4.7 for a more precise statement.)

Furthermore, we will show that the isomorphisms from Theorem 1.3 are functorial in the following sense: They allow an expression of maps associated to cobordisms $S \subset \partial W_1 \times I$ between links $S: L \rightarrow L'$ in $\partial W_1 = \#^m(S^1 \times S^2)$ in terms of components computed entirely from maps associated to link cobordisms in S^3 .

By combining Theorems 1.2 and 1.3 (plus the functoriality statement), we thus obtain a recipe for expressing the lasagna skein modules of any four-manifold in terms of Khovanov–Rozansky homologies of links in S^3 and maps associated to cobordisms in $S^3 \times I$. The invariant is a quotient

of a (typically infinite) direct sum of homologies of links by a subspace defined in terms of link cobordism maps.

Remark 1.4. Although the invariant $\mathcal{S}_0^N(W; L, \mathbb{k})$ for any four-manifold W can be expressed purely in terms of link homology in S^3 , specifically KhR_N , it would be difficult to prove directly that these expressions yield a four-manifold invariant. A direct proof of invariance, without comparing to the intrinsically defined invariants \mathcal{S}_0^N , would require checking handle slide and handle cancellation moves as well as higher coherence conditions between their composites. Handle slides for 2-handles are studied (for $N = 2$) in [15] and instances of (2, 3)-handle cancellation are discussed in Example 3.8. Another interesting question concerns the behaviour of our algebraic description of $\mathcal{S}_0^N(W; L, \mathbb{k})$ under reversing the handle decomposition of W . However, our approach uses transversality arguments to isotope skeins away from cocores of handles to yield simplified handle formulas; hence, we do not expect these formulas to reflect the duality between k - and $(4-k)$ -handles, because the duality does not respect cocores.

Specializing the setting of Theorem 1.3 to the case of a single 1-handle, we consider the link $S^1 \times P_p \subset S^1 \times B^3$ consisting of $2p$ parallel circles, with p of them oriented one way and p the other way. We prove that $\mathcal{S}_0^N(S^1 \times B^3, S^1 \times P_p)$ is isomorphic to the zeroth Hochschild homology of the category $\mathcal{S}_0^N(B^3; P_{p_i})$. From here we get the following explicit calculation for $N = 2$.

Theorem 1.5. *The skein lasagna module $\mathcal{S}_0^2(S^1 \times B^3; S^1 \times P_p, \mathbb{k})$ is*

- (a) *one-dimensional when $p = 0$;*
- (b) *four-dimensional when $p = 1$;*
- (c) *infinite dimensional when $p \geq 2$.*

Using methods analogous to those employed in part (a), we also show that $\mathcal{S}_0^2(S^1 \times S^3, \mathbb{k})$ is one-dimensional; see Corollary 4.2. For part (c), we actually show that $\mathcal{S}_0^2(S^1 \times B^3, S^1 \times P_p, \mathbb{k})$ is infinite dimensional in bidegree $(0, 0)$. This answers in the negative Question 1.7 from [25], about whether skein lasagna modules are always locally finite dimensional, i.e., finite dimensional in each fixed bidegree and homology class.

This still leaves open the following:

Question 1.6. *If W is simply connected, is $\mathcal{S}_0^N(W; L, \mathbb{k})$ always locally finite dimensional?*

For $W_1 = \natural^m(S^1 \times B^3)$, one can view the skein lasagna module $\mathcal{S}_0^2(W_1; L)$ as a variant of Khovanov homology for links L in $\#^m(S^1 \times S^2)$. Another version of Khovanov homology for these links was constructed by Rozansky (for $m = 1$) in [31], and Willis [33] for arbitrary m . The Rozansky–Willis homology $H_{\text{RW}}^{*,*}(L)$ is finitely generated in each bidegree and, thus, different from our theory. We expect that $H_{\text{RW}}^{*,*}(L)$ appears on the E_2 page of a spectral sequence converging to $\mathcal{S}_0^2(W_1; L)$. See Section 4.6 for a further discussion and Section 4.7 for a conjectural extension of the Rozansky–Willis homology to links in the boundary of other four-manifolds.

Organization of the paper. In Section 2 we go over a few preliminaries about skein lasagna modules and Kirby diagrams. In Section 3 we study the behavior of skein lasagna modules under attaching 2- and 3-handles, proving Theorems 1.1 and 1.2. In Section 4 we focus on 1-handles, and prove Theorems 1.3 and 1.5.

Conventions. All the manifolds considered in this paper will be smooth, compact, and oriented. All links and surfaces are oriented and normally framed.

Acknowledgements. This paper builds on previous joint work and many enlightening conversations of KW and PW with Scott Morrison, without which this paper probably would not exist. We would also like to thank Matthew Hogancamp and Ikshu Neithalath for helpful comments on a draft of this paper.

2. PRELIMINARIES

2.1. Skein lasagna modules. We start by reviewing the construction of skein lasagna modules from [27, Section 5.2].

Following [27] and [25], for a framed link $L \subset \mathbb{R}^3$, we write

$$\mathrm{KhR}_N(L) = \bigoplus_{i,j \in \mathbb{Z}} \mathrm{KhR}_N^{i,j}(L)$$

for the \mathfrak{gl}_N version of Khovanov-Rozansky homology. Here, i denotes the homological grading and j denotes the quantum grading.

If we have an oriented manifold S diffeomorphic to the standard 3-sphere S^3 , and a framed link $L \subset S$, we can define a canonical invariant $\mathrm{KhR}_N(S, L)$ as in [27, Definition 4.12]. We sometimes drop S from the notation and simply write $\mathrm{KhR}_N(L)$.

Given a framed cobordism $\Sigma \subset S^3 \times [0, 1]$ from L_0 to L_1 , there is an induced map

$$\mathrm{KhR}_N(\Sigma): \mathrm{KhR}_N(L_0) \rightarrow \mathrm{KhR}_N(L_1)$$

which is homogeneous of bidegree $(0, (1 - N)\chi(\Sigma))$.

Let W be a four-manifold and $L \subset \partial W$ a framed link. A *lasagna filling* $F = (\Sigma, \{(B_i, L_i, v_i)\})$ of W with boundary L consists of

- A finite collection of disjoint 4-balls B_i (called *input balls*) embedded in the interior of W ;
- A framed oriented surface Σ properly embedded in $W \setminus \cup_i B_i$, meeting ∂W in L and meeting each ∂B_i in a link L_i ; and
- for each i , a homogeneous label $v_i \in \mathrm{KhR}_N(\partial B_i, L_i)$.

The bidegree of a lasagna filling F is

$$\mathrm{deg}(F) := \sum_i \mathrm{deg}(v_i) + (0, (1 - N)\chi(\Sigma)).$$

If W is a 4-ball, we can define a cobordism map

$$\mathrm{KhR}_N(\Sigma): \bigotimes_i \mathrm{KhR}_N(\partial B_i, L_i) \rightarrow \mathrm{KhR}_N(\partial W, L)$$

and an evaluation

$$\mathrm{KhR}_N(F) := \mathrm{KhR}_N(\Sigma)(\otimes_i v_i) \in \mathrm{Kh}(\partial W, L).$$

We define the skein lasagna module as the bigraded abelian group

$$\mathcal{S}_0^N(W; L) := \mathbb{Z}\{\text{lasagna fillings } F \text{ of } W \text{ with boundary } L\} / \sim$$

where \sim is the transitive and linear closure of the following relation:

- Linear combinations of lasagna fillings are set to be multilinear in the labels v_i ;
- Furthermore, two lasagna fillings F_1 and F_2 are set to be equivalent if F_1 has an input ball B_i with label v_i , and F_2 is obtained from F_1 by replacing B_i with another lasagna filling F_3 of a 4-ball such that $v_i = \mathrm{KhR}_N(F_3)$, followed by an isotopy rel ∂W (where the isotopy is allowed to move the input balls):

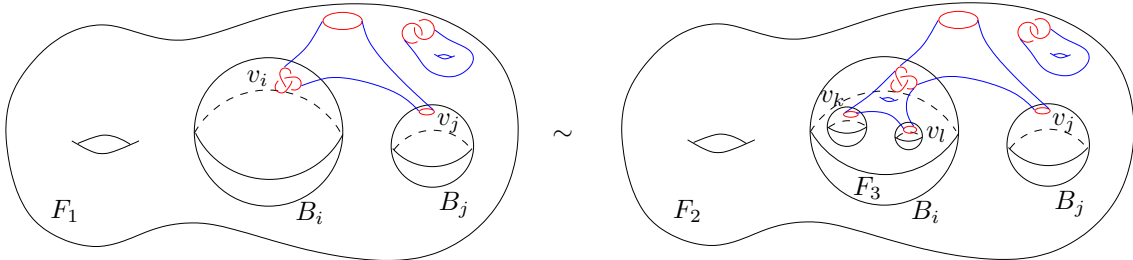

For future reference, here is a useful lemma.

Lemma 2.1. *Let W and L be as above, and fix balls R_1, \dots, R_n , one in each connected component of W . Then, the equivalence relation defining $\mathcal{S}_0^N(W; L)$ can be alternatively be described as the transitive and linear closure of the following relation:*

- *Linear combinations of lasagna fillings are set to be multilinear in the labels v_i ;*
- *Lasagna fillings that are isotopic rel ∂W are set to be equivalent;*
- *Two lasagna fillings are also set to be equivalent if they differ as in (b) above, where the input ball B_i is one of the chosen balls R_1, \dots, R_n .*

Proof. If F_1 and F_2 are equivalent as in the lemma, let us show that they are equivalent as in the definition of the skein lasagna module. The only new relation is the isotopy, which can be thought of as a particular instance of (b), where B_1 is replaced by a slightly smaller ball with the same decoration (and F_3 is a product cobordism).

Conversely, if F_1 and F_2 are equivalent as in the definition of the skein lasagna module, we only have to consider the case when they are related by (b). We can then isotope B_i to turn it into the ball R_j in the same connected component, and view (b) as a combination of the moves in the lemma. \square

Skein lasagna modules decompose according to relative homology classes, as noted in [25, Section 2.3]:

$$(1) \quad \mathcal{S}_0^N(W; L) = \bigoplus_{\alpha \in H_2(W, L; \mathbb{Z})} \mathcal{S}_0^N(W; L, \alpha).$$

Observe that in the case where L is not null-homologous in W (i.e. $[L] \neq 0 \in H_1(W; \mathbb{Z})$), then there are no lasagna fillings, so $\mathcal{S}_0^N(W; L) = 0$. When $[L] = 0 \in H_1(W; \mathbb{Z})$, consider the boundary map in the long exact sequence of the pair (W, L) :

$$\partial : H_2(W, L; \mathbb{Z}) \rightarrow H_1(L; \mathbb{Z}).$$

The only classes $\alpha \in H_2(W, L; \mathbb{Z})$ that can contribute non-trivially are those that map to the fundamental class $[L] \in H_1(L; \mathbb{Z})$ under ∂ . Let us introduce the notation

$$H_2^L(W; \mathbb{Z}) := \partial^{-1}([L]) \subseteq H_2(W, L; \mathbb{Z}).$$

Note that, using the long exact sequence of the pair, the difference of two classes in $H_2^L(W; \mathbb{Z})$ can be identified with an element of $H_2(W; \mathbb{Z})$. Thus, $H_2^L(W; \mathbb{Z})$ is a torsor over $H_2(W; \mathbb{Z})$; it can be identified with the latter group after choosing a base element in $H_2^L(W; \mathbb{Z})$.

The decomposition (1) becomes

$$(2) \quad \mathcal{S}_0^N(W; L) = \bigoplus_{\alpha \in H_2^L(W; \mathbb{Z})} \mathcal{S}_0^N(W; L, \alpha).$$

We will use the decomposition (2) in the case of a general link L ; when $[L] \neq 0$, we have $H_2^L(W; \mathbb{Z}) = \emptyset$ and $\mathcal{S}_0^N(W; L) = 0$.

2.2. Gluing and cobordisms. Let us consider two four-manifolds W and Z that have some part Y of their boundaries in common, as follows:

$$\partial W = Y \amalg Y_0, \quad \partial Z = (-Y) \amalg Y_1,$$

where \amalg denotes disjoint union. We can glue W and Z along Y to form a new four-manifold $W \cup Z$ with boundary $Y_0 \amalg Y_1$. Suppose we are also given links $L_0 \subset Y_0$, $L_1 \subset Y_1$ and $L \subset Y$. Let $\bar{L} \subset -Y$ denote the mirror reverse of L . Then, we have a map

$$(3) \quad \Psi : \mathcal{S}_0^N(W; L \cup L_0) \otimes \mathcal{S}_0^N(Z; \bar{L} \cup L_1) \rightarrow \mathcal{S}_0^N(W \cup Z; L_0 \cup L_1)$$

obtained by gluing lasagna fillings along L :

$$[F] \otimes [G] \mapsto [F \cup G].$$

It is easy to see that if two lasagna fillings F_1 and F_2 are equivalent in W , and G_1 and G_2 are equivalent in Z , then $F_1 \cup G_1$ and $F_2 \cup G_2$ are equivalent in $W \cup Z$, so (3) is well-defined.

Starting from here, we see that skein lasagna modules are functorial under inclusions, in the following sense. We consider the case when $Y_0 = \emptyset$, and we fix a lasagna filling G of Z with boundary $\bar{L} \cup L_1$. We can think of Z as a cobordism from $Y = \partial W$ to Y_1 . Then, there is an induced cobordism map

$$(4) \quad \Psi_{Z;G} = \Psi(\cdot \otimes [G]) : \mathcal{S}_0^N(W; L) \rightarrow \mathcal{S}_0^N(W \cup Z; L_1).$$

Observe that the maps (4) behave well with respect to compositions:

$$(5) \quad \Psi_{Z';G'} \circ \Psi_{Z;G} = \Psi_{Z \cup Z'; G \cup G'}.$$

Furthermore, in terms of the decompositions (2), given $\alpha \in H_2^L(W; \mathbb{Z})$, by attaching to it the class of G in $H_2^{L \cup L_1}(Z; \mathbb{Z})$ we get a class $\alpha_1 \in H_2^{L_1}(W \cup Z; \mathbb{Z})$. Then, $\Psi_{Z;G}$ maps $\mathcal{S}_0^N(W; L, \alpha)$ to $\mathcal{S}_0^N(W \cup Z; L_1, \alpha_1)$. We let

$$(6) \quad \Psi_{Z;G,\alpha} : \mathcal{S}_0^N(W; L, \alpha) \rightarrow \mathcal{S}_0^N(W \cup Z; L_1, \alpha_1)$$

denote the restriction of $\Psi_{Z;G}$.

When the lasagna filling G consists of a surface S (an embedded cobordism $S \subset Z$ from L to L_1) with no input balls, we will simply write $\Psi_{Z;S,\alpha}$ for $\Psi_{Z;G,\alpha}$. Furthermore, we could decorate S with n dots at a chosen location, for $0 \leq n \leq N-1$, as usual in \mathfrak{gl}_N foams; cf. [27, Example 2.3]. This corresponds to constructing a lasagna filling $S(n\bullet)$ with n input balls intersecting S along unknots, each decorated with the generator

$$X \in \text{KhR}_N(U) \cong \mathbb{Z}[X]/(X^N).$$

(This filling is equivalent to one where we consider a single input ball intersecting S in an unknot, decorated with X^n .) When the chosen location of the dot placement is clear from the context, then we denote the corresponding map by

$$(7) \quad \Psi_{Z;S(n\bullet),\alpha} : \mathcal{S}_0^N(W; L, \alpha) \rightarrow \mathcal{S}_0^N(W \cup Z; L_1, \alpha_1).$$

2.3. Kirby diagrams. Let W be a smooth, oriented, connected, compact four-manifold (possibly with boundary). By standard Morse theory, W can be decomposed into k -handles for $k = 0, \dots, 4$, arranged according to their index k . Furthermore, without loss of generality, we can arrange so that there is a unique 0-handle, and the number of 4-handles is either 0 or 1, according to whether W has empty boundary or not.

Denote the numbers of 1-, 2- and 3-handles by m , n and p , respectively. After attaching the 1-handles to the 0-handle we get the handlebody $\natural^m(S^1 \times B^3)$, with boundary $\#^m(S^1 \times S^2)$. (Here, \natural denotes the boundary connected sum, and $\#$ the usual interior connected sum.) The attaching circles for the 2-handles form a link

$$K \subset \#^m(S^1 \times S^2),$$

with components K_1, \dots, K_n . The link also has a framing, which specifies how the 2-handles are attached. Once these are attached, the boundary of the resulting manifold must be of the form $Y \#^p(S^1 \times S^2)$. Attaching the 3-handles gets rid of the p summands of $S^1 \times S^2$, so the resulting boundary is some 3-manifold Y . In the case $\partial W \neq \emptyset$, we stop here and we have $\partial W = Y$. In the case where W is closed, we must have $Y = S^3$ and we attach the 4-handle (a four-ball) to S^3 at the last step to eliminate the boundary.

The handle decomposition allows us to represent W by a *Kirby diagram*. This consists of drawing $\#^m(S^1 \times S^2)$ as m pairs of spheres in \mathbb{R}^3 , where we think of the spheres in each pair as identified to produce a 1-handle (and we also add the point at infinity to \mathbb{R}^3). We then draw a picture of the attaching link K for the 2-handles, where the link can go through the 1-handles. The framing of K can be specified by drawing parallel copies of the components of K . (The components that don't

go through the 1-handles can be viewed as living in S^3 ; for those, an alternative way to specify the framing is by an integer, which is the difference between the given framing and the Seifert framing.) To determine W , in principle we should also specify the attaching spheres for the 3-handles. These are usually not drawn in the Kirby diagram. In the case where $\partial W = \emptyset$, this leaves no ambiguity, because there is a unique way to fill $\#^p(S^1 \times S^2)$ by 3-handles and then by a 4-handle.

For example, we show here a Kirby diagram of $W = \mathbb{C}P^2 \# \mathbb{C}P^2$ with one 1-handle and three 2-handles. For the attaching curve of the 2-handle that goes through the 1-handle, we specified the framing by drawing a parallel copy by a dashed curve; for the other 2-handles, we used numbers:

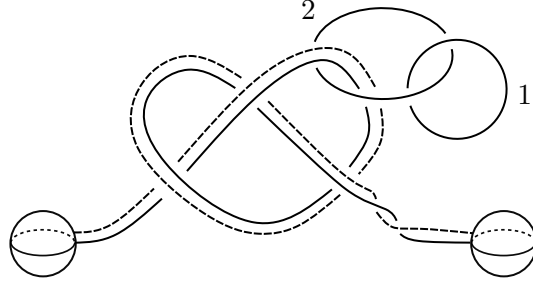

For more details about the subject, we refer to the book [10].

3. TWO- AND THREE-HANDLES

3.1. Two-handles. The paper [25] contains a description of the skein lasagna module for 2-handlebodies (four-manifolds W made of a 0-handle and some 2-handles), where the link $L \subset \partial W$ is empty, or at least local (contained in a 3-ball). The description is in terms of the Khovanov-Rozansky homology of cables of the attaching link K .

In this subsection we extend that description to the case where we attach 2-handles to any four-manifold W , to obtain a new manifold W' . Moreover, we do not impose any restriction on the link $L \subset \partial W$. The formula is very similar to that in [25]. The role of the Khovanov-Rozansky homology KhR_N will be played by the skein lasagna module $\mathcal{S}_0^N(W; -)$, which can be thought of as a link homology for links in the boundary of W . (When $W = B^4$, we have $\mathcal{S}_0^N(W; L) = \text{KhR}_N(L)$.)

Let K_1, \dots, K_n be the components of the framed link $K \subset \partial W$ along which the 2-handles are attached. The framing gives diffeomorphisms f_i between tubular neighborhoods $\nu(K_i)$ of each K_i and $S^1 \times D^2$. Given n -tuples of nonnegative integers

$$k^- = (k_1^-, \dots, k_n^-), \quad k^+ = (k_1^+, \dots, k_n^+),$$

we let $K(k^-, k^+)$ denote the framed, oriented cable of K consisting of k_i^- negatively oriented parallel strands to K_i and k_i^+ positively oriented parallel strands. Here, the notion of parallelism for the strands is determined by the framing, that is,

$$K(k^-, k^+) = \bigcup_i f_i^{-1}(S^1 \times \{x_1^-, \dots, x_{k_i^-}^-, x_1^+, \dots, x_{k_i^+}^+\})$$

for fixed points $x_1^-, \dots, x_{k_i^-}^-, x_1^+, \dots, x_{k_i^+}^+ \in D^2$.

After attaching 2-handles to W along K , we obtain the manifold W' . Suppose we are given a framed link $L \subset \partial W'$. Generically, we can assume that L stays away from the attaching regions of the 2-handles, and therefore we can represent it as a link in ∂W , disjoint from (but possibly linked with) K . (There are various ways of isotoping L off of the attaching regions; the results of the calculation will be isomorphic.) We let

$$K(k^-, k^+) \cup L$$

be the union of $K(k^-, k^+)$ and L , where we do the cabling on the components of K by choosing the tubular neighborhoods of K_i to be disjoint from L . (Note that $K(k^-, k^+) \cup L$ is not a split disjoint union.)

We seek to express the skein lasagna module $\mathcal{S}_0^N(W'; L)$ in terms of $\mathcal{S}_0^N(W; K(k^-, k^+) \cup L)$. To do this, we need to introduce a few more notions.

For each i , let $B_{k_i^-, k_i^+}$ be the subgroup of the braid group on $k_i^- + k_i^+$ strands that consists of self-diffeomorphisms of D^2 rel boundary (modulo isotopy rel boundary) taking the set $\{x_1^-, \dots, x_{k_i^-}^-\}$ to itself and the set $\{x_1^+, \dots, x_{k_i^+}^+\}$ to itself. By taking the product with the identity on S^1 , a braid element $b \in B_{k_i^-, k_i^+}$ induces a self-diffeomorphism of $D^2 \times S^1$, which can be pulled back (via f_i) to a self-diffeomorphism of $\nu(K_i)$. This gives a group action

$$\beta_i : B_{k_i^-, k_i^+} \rightarrow \text{Aut}(\mathcal{S}_0^N(W; K(k^-, k^+) \cup L)).$$

Let $e_i \in \mathbb{Z}^n$ denote the i^{th} basis vector. Two strands parallel to K_i , if they have opposite orientations, co-bound a ribbon band R_i in S^3 . By pushing R_i into $S^3 \times [0, 1]$ so that it is properly embedded there, and taking the disjoint union with the identity cobordisms on the other strands, we obtain an oriented cobordism (still denoted R_i) from $K(k^-, k^+) \cup L$ to $K(k^- + e_i, k^+ + e_i) \cup L$. For $d = 0, 1, \dots, N-1$, we can decorate R_i with d dots, and obtain a cobordism map

$$\psi_i^{[d]} : \mathcal{S}_0^N(W; K(k^-, k^+) \cup L) \rightarrow \mathcal{S}_0^N(W; K(k^- + e_i, k^+ + e_i) \cup L),$$

which changes the bigrading by $(0, 2d)$.

Next, recall that we have a decomposition (2) for the skein lasagna module $\mathcal{S}_0^N(W'; L)$, according to homology classes in $H_2^L(W'; \mathbb{Z})$. Let us see how these homology classes are related to the similar ones in W . Consider the tubular neighborhood $\nu(K) = \cup_i \nu(K_i)$, which is a union of solid tori. Express W' as the union

$$W' = W \cup C \cup Z,$$

where Z is the union of the new 2-handles, and $C \cong \nu(K) \times [0, 1]$ is a connecting cylinder between W and Z . Let also

$$C' = \nu(K) \times \{0, 1\} \subset C.$$

We identify $\nu(K)$ with $\nu(K) \times \{0\}$ and denote $\nu(K) \times \{1\}$ by $\partial_- Z$ (part of the boundary ∂Z).

The Mayer-Vietoris sequence for W' relative to the union of W and $Z \cup L$ reads

$$\dots \rightarrow H_*(W', W \cap (Z \cup L); \mathbb{Z}) \rightarrow H_*(W', W; \mathbb{Z}) \oplus H_*(W', Z \cup L; \mathbb{Z}) \rightarrow H_*(W', W \cup (Z \cup L); \mathbb{Z}) \rightarrow \dots$$

Observe that, by excision, $H_3(W', W \cup (Z \cup L); \mathbb{Z}) \cong H_3(C, C'; \mathbb{Z}) = 0$. From here we obtain an exact sequence

$$(8) \quad 0 \rightarrow H_2(W', L; \mathbb{Z}) \rightarrow H_2(Z, \partial_- Z; \mathbb{Z}) \oplus H_2(W, \nu(K) \cup L; \mathbb{Z}) \rightarrow H_2(C, C'; \mathbb{Z}).$$

Thus, an element in $H_2^L(W'; \mathbb{Z}) \subseteq H_2(W', L; \mathbb{Z})$ can be identified with its image in $H_2(Z, \partial_- Z; \mathbb{Z}) \oplus H_2(W, \nu(K) \cup L; \mathbb{Z})$, which we write as a pair (α, η) .

Let us further identify $H_2(Z, \partial_- Z; \mathbb{Z})$ with \mathbb{Z}^n by letting the i th handle correspond to the coordinate vector e_i . Then, we write

$$\alpha = (\alpha_1, \dots, \alpha_n) \in \mathbb{Z}^n$$

and let α^+ denote its positive part and α^- its negative part; i.e., $\alpha_i^+ = \max(\alpha_i, 0)$ and $\alpha_i^- = \min(\alpha_i, 0)$. We also let $|\alpha| = \sum_i |\alpha_i|$.

Let $r \in \mathbb{N}^n$ and consider the cable $K(r - \alpha^-, r + \alpha^+)$. The fact that $(\alpha, \eta) \in \mathbb{Z}^n \oplus H_2(W, \nu(K) \cup L; \mathbb{Z})$ is in the kernel of the map to $H_2(C, C'; \mathbb{Z}) \cong \mathbb{Z}^n$ in (8) implies the existence of a (unique) class

$$\eta^r \in H_2^{L \cup K(r - \alpha^-, r + \alpha^+)}(W; \mathbb{Z}) \subseteq H_2(W, L \cup K(r - \alpha^-, r + \alpha^+); \mathbb{Z})$$

which is sent to η by the natural map to $H_2(W, L \cup \nu(K); \mathbb{Z})$.

From now on, using the deformation retraction from $\nu(K)$ to K , let us think of η as a class in $H_2(W, K \cup L; \mathbb{Z})$.

Definition 3.1. *The cabled skein lasagna module of $K \subset \partial W$ at level α and in class η is*

$$\underline{\mathcal{S}}_0^{N,\alpha}(W; K, L, \eta) = \left(\bigoplus_{r \in \mathbb{N}^n} \mathcal{S}_0^N(W; K(r - \alpha^-, r + \alpha^+) \cup L, \eta^r) \{ (1 - N)(2|r| + |\alpha|) \} \right) / \sim$$

where the equivalence \sim is the transitive and linear closure of the relations

$$(9) \quad \beta_i(b)v \sim v, \quad \psi_i^{[d]}(v) \sim 0 \text{ for } d < N - 1, \quad \psi_i^{[N-1]}(v) \sim v$$

for all $i = 1, \dots, n$; $b \in B_{k_i^-, k_i^+}$, and $v \in \mathcal{S}_0^N(W; K(r - \alpha^-, r + \alpha^+) \cup L, \eta^r)$.

Theorem 3.2. *Let W be a four-manifold and $L \subset \partial W$ be a framed link. Let W' be obtained from W by attaching 2-handles along a framed link K disjoint from L . Then, for each $(\alpha, \eta) \in H_2^L(W'; \mathbb{Z})$, we have an isomorphism*

$$\Phi : \underline{\mathcal{S}}_0^{N,\alpha}(W; K, L, \eta) \xrightarrow{\cong} \mathcal{S}_0^N(W'; L, (\alpha, \eta)).$$

Proof. An element $v \in \mathcal{S}_0^N(W; K(r - \alpha^-, r + \alpha^+) \cup L, \eta^r)$ is represented by a linear combination of lasagna fillings $(\Sigma, \{(B_i, L_i, v_i)\})$ in W , where $\partial\Sigma = K(r - \alpha^-, r + \alpha^+) \cup L \cup (\cup_i L_i)$. We define $\Phi(v)$ to be the class of the linear combination of lasagna fillings with the same input data $\{(B_i, L_i, v_i)\}$ as v , but with the surfaces given by attaching to each Σ (along its boundary) the disjoint union of $r_i - \alpha_i^-$ negatively oriented discs parallel to the core of i^{th} 2-handle and $r_i + \alpha_i^+$ positively oriented such discs (union over all i).

We also define a map Φ^{-1} in the opposite direction, as follows. Let F be a lasagna filling in W' with surface Σ . We isotope the input balls of F to be inside W , and isotope the surface Σ such that its intersection with the 2-handles consists of several disks parallel to their cores. Removing these disks produces a lasagna filling of W with boundary on a link of the form $K(r - \alpha^-, r + \alpha^+) \cup L$. We let this be $\Phi^{-1}(F)$.

The proofs that Φ and Φ^{-1} are well-defined and inverse to each other are similar to the proof of Theorem 1.1 in [25], which dealt with the case $W = B^4$ and $L = \emptyset$. The extension to arbitrary W and L is obtained by replacing the Khovanov-Rozansky homologies KhR_N with the skein lasagna modules in W . (In the formulation here, the proof of the statement is even slightly clearer since it relates lasagna skein modules with lasagna skein modules. In particular, we do not have to choose standard lasagna fillings with ‘‘slightly smaller input balls’’, as these were only required when comparing $\mathcal{S}_0^N(B^4, -)$ with KhR_N .) \square

Remark 3.3. In some cases it is known that the braid group actions on the link homology of cabled links factor through the symmetric group. For Khovanov homology of links in \mathbb{R}^3 , this was shown by Grigsby–Licata–Wehrli [12, Theorem 2]. For the \mathfrak{gl}_N homology of links in \mathbb{R}^3 (or S^3) a similar argument works in the case of *parallelly oriented* strands [11, Section 6.1]. We have no reason to doubt that the same could be true for anti-parallel strands, i.e. in the situation relevant for \mathcal{S}_0^N , but we do not currently know how to prove it.

We will primarily be using the results from this subsection in the case where the role of W is played by

$$W_1 := \natural^m(S^1 \times B^3),$$

a manifold obtained from a 0-handle by attaching some 1-handles. We denote W' by W_2 . Then, $H_2(W_1; \mathbb{Z}) = 0$, so $H_2^L(W_1; \mathbb{Z}) = 0$ for any null-homologous L , and the decomposition (2) for skein lasagna modules of links in W_1 is trivial (consists of a single summand). Moreover, in this case an element $(\alpha, \eta) \in H_2^L(W_2; \mathbb{Z}) \subseteq H_2(W_2, L; \mathbb{Z})$ is uniquely determined by its image α in $H_2(W_2, W_1; \mathbb{Z}) \cong \mathbb{Z}^n$. Indeed, the exact sequence

$$0 = H_2(W_1; \mathbb{Z}) \rightarrow H_2(W_1, L \cup \nu(K); \mathbb{Z}) \rightarrow H_1(L \cup \nu(K); \mathbb{Z})$$

show that the component η is determined by its image in

$$H_1(L \cup \nu(K); \mathbb{Z}) = H_1(L; \mathbb{Z}) \oplus H_1(\nu(K); \mathbb{Z}).$$

The part in $H_1(L; \mathbb{Z})$ has to be the fundamental class $[L]$, while the part in $H_1(\nu(K); \mathbb{Z}) \cong \mathbb{Z}^n$ is the image of α under the isomorphisms

$$H_2(W_2, W_1; \mathbb{Z}) \xrightarrow{\cong} H_2(Z, \partial_- Z; \mathbb{Z}) \xrightarrow{\cong} H_1(\partial_- Z; \mathbb{Z}) \xrightarrow{\cong} H_1(\nu(K); \mathbb{Z}).$$

Therefore, in this case the class η is redundant (being determined by α), so we simply drop it from the notation, writing for example α instead of (α, η) for the classes in $H_2^L(W_2; \mathbb{Z})$. With this in mind, the isomorphism from Theorem 3.2 is written as

$$(10) \quad \Phi : \underline{\mathcal{S}}_0^{N, \alpha}(W_1; K, L) \xrightarrow{\cong} \mathcal{S}_0^N(W_2; L, \alpha).$$

3.2. Three-handles. In [25, Proposition 2.1] the following result was shown:

Proposition 3.4. *Let $i: W \rightarrow W'$ be the inclusion of a four-manifold W into W' . Then we have a natural map*

$$i_* : \mathcal{S}_0^N(W; \emptyset) \rightarrow \mathcal{S}_0^N(W', \emptyset).$$

If W' is the result of a k -handle attachment to W , then i_ is a surjection for $k = 3$ and an isomorphism for $k = 4$.*

Corollary 3.5. *We have $\mathcal{S}_0^N(S^4) \cong \mathbb{Z}$, concentrated in bidegree zero.*

In this section we focus on the case of 3-handle attachments. We will generalize the statement of Proposition 3.4 to 3-handle attachments in the presence of boundary links and explicitly describe the kernel of the resulting maps on \mathcal{S}_0^N .

Consider the following setting. Let W be a four-manifold with a framed link $L \subset Y = \partial W$ and an embedded 2-dimensional sphere $S \subset Y$, disjoint from L . Let Z be the cobordism given by attaching a 3-handle to W along S , and let

$$W' = W \cup Z.$$

Let $Y' = \partial W'$ be the outgoing boundary of Z , so that $\partial Z = (-Y) \cup Y'$. Inside Z we have the two-dimensional annular cobordism $A = I \times L$, from $L = \{0\} \times L$ to a new link $L' = \{1\} \times L$. Given $\alpha' \in H_2^L(W'; \mathbb{Z}) \cong H_2^L(W; \mathbb{Z}) / ([S])$, let us consider the set of all $\alpha \in H_2^L(W; \mathbb{Z})$ whose equivalence class modulo $[S]$ is α' :

$$\langle \alpha' \rangle := \{ \alpha \in H_2^L(W; \mathbb{Z}) \mid \alpha \bmod [S] = \alpha' \}.$$

We obtain a cobordism map as in (6):

$$\Psi_{Z; A, \alpha} : \mathcal{S}_0^N(W; L, \alpha) \rightarrow \mathcal{S}_0^N(W'; L', \alpha').$$

Let

$$\Psi_{Z; A, \alpha'} := \sum_{\alpha \in \langle \alpha' \rangle} \Psi_{Z; A, \alpha} : \bigoplus_{\alpha \in \langle \alpha' \rangle} \mathcal{S}_0^N(W; L, \alpha) \rightarrow \mathcal{S}_0^N(W'; L', \alpha').$$

Remark 3.6. When $L = \emptyset$ (and therefore $A = \emptyset$), then $\Psi_{Z; \emptyset}$ is exactly the map i_* from Proposition 3.4.

Let J be the equator of S (which is an unknot in Y). Equip J with an arbitrary orientation. By pushing a hemisphere of S slightly from $Y = \{0\} \times Y$ into the cylinder $I \times Y$, and taking its union with $I \times L$, we obtain a properly embedded cobordism in $I \times Y$, going from $L \cup J$ to L . There are two such hemispheres, which produce two cobordisms, denoted Δ_+ and $\Delta_- \subset I \times Y$. We orient Δ_+ and Δ_- so that their boundary orientation is the one on J . (Note that they are therefore “oppositely oriented,” in the sense that they do not match up to produce an orientation

on S .) Let us identify $W \cup (I \times Y)$ with W itself using a standard collar neighborhood. Then, the cobordism maps associated to Δ_+ and Δ_- take the form

$$\begin{aligned}\Psi_{I \times Y; \Delta_+, \alpha} &: \mathcal{S}_0^N(W; L \cup J, \alpha + [\Delta_+]) \rightarrow \mathcal{S}_0^N(W; L, \alpha), \\ \Psi_{I \times Y; \Delta_-, \alpha} &: \mathcal{S}_0^N(W; L \cup J, \alpha + [\Delta_-]) \rightarrow \mathcal{S}_0^N(W; L, \alpha).\end{aligned}$$

From here we get direct sum maps

$$\Psi_{I \times Y; \Delta_+, \alpha'} := \bigoplus_{\alpha \in \langle \alpha' \rangle} \Psi_{I \times Y; \Delta_+, \alpha}$$

and

$$\Psi_{I \times Y; \Delta_-, \alpha'} := \bigoplus_{\alpha \in \langle \alpha' \rangle} \Psi_{I \times Y; \Delta_-, \alpha}.$$

Observe that these two maps have the same domain

$$\bigoplus_{\alpha \in \langle \alpha' \rangle} \mathcal{S}_0^N(W; L \cup J, \alpha + [\Delta_+]) = \bigoplus_{\alpha \in \langle \alpha' \rangle} \mathcal{S}_0^N(W; L \cup J, \alpha + [\Delta_-])$$

and the same range $\bigoplus_{\alpha \in \langle \alpha' \rangle} \mathcal{S}_0^N(W; L, \alpha)$. Let

$$f := \Psi_{I \times Y; \Delta_+, \alpha'} - \Psi_{I \times Y; \Delta_-, \alpha'}.$$

Theorem 3.7. *The map $\Psi_{Z; A, \alpha'}$ associated to a 3-handle addition from W to W' is surjective, and its kernel is exactly the image of f . Therefore, $\mathcal{S}_0^N(W', L', \alpha')$ is isomorphic to*

$$\left(\bigoplus_{\alpha \in \langle \alpha' \rangle} \mathcal{S}_0^N(W, L, \alpha) \right) / \text{im}(f),$$

that is, to the coequalizer of the maps $\Psi_{I \times Y; \Delta_+, \alpha'}$ and $\Psi_{I \times Y; \Delta_-, \alpha'}$.

Proof. We first show that $\Psi_{Z; A, \alpha'}$ vanishes on the image of f , that is,

$$\Psi_{Z; A, \alpha'} \circ \Psi_{I \times Y; \Delta_+, \alpha'} = \Psi_{Z; A, \alpha'} \circ \Psi_{I \times Y; \Delta_-, \alpha'}.$$

Indeed, from the composition law (5) we see that the left hand side is associated to the surface cobordism $\Delta_+ \cup A$ and the right hand side to $\Delta_- \cup A$. However, inside the 3-handle Z , the sphere S gets filled with a core B^3 , and therefore Δ_+ and Δ_- are isotopic rel boundary. It follows that the two cobordism maps are the same.

Therefore, $\Psi_{Z; A, \alpha}$ factors through a map

$$\Phi: \left(\bigoplus_{\alpha \in \langle \alpha' \rangle} \mathcal{S}_0^N(W, L, \alpha) \right) / \text{im}(f) \rightarrow \mathcal{S}_0^N(W', L', \alpha').$$

We need to prove that Φ is bijective. For this, we construct its inverse Φ^{-1} . Given a lasagna filling F' of W' with boundary L' , observe that the cocore of the 3-handle Z is one-dimensional, and therefore we can isotope F' to be disjoint from this cocore; after this, we can push it into W , to obtain a lasagna filling there, called F , with boundary L . We set

$$\Phi^{-1}[F'] = [F].$$

To see that Φ^{-1} is well-defined, we need to check that if two lasagna fillings F'_0 and F'_1 are equivalent in W' , then the corresponding fillings F_0 and F_1 differ (up to equivalences in W) by an element of $\text{im}(f)$. We use Lemma 2.1, in which we fix balls $R_i \subset W$ away from the 3-handle, and consider the equivalences listed in the lemma (with the ball replacements happening in R_i). Then, the equivalences in W' give rise to equivalences in W , with one exception: an isotopy of the surfaces may intersect the one-dimensional cocore of Z (which is an interval). Generically, this happens in a finite set of points, each point at a different time during the isotopy. Every time the isotopy meets the cocore, the corresponding surfaces in W differ by replacing a hemisphere of S (with boundary

some closed curve γ) with its complement in S . Up to an isotopy supported near S , we can assume that γ is the equator J with its chosen orientation. (For example, if γ is J with the opposite orientation, we can rotate it by π about a transverse axis to get J with the original orientation.) Then, the hemispheres being interchanged are Δ_+ and Δ_- and hence the classes of F_0 and F_1 differ by an element in the image of f .

This shows that Φ^{-1} is well-defined, and its definition makes it clear that it is an inverse to Φ . It follows that Φ is bijective, and the conclusions follow. \square

Example 3.8. Let $W = S^2 \times D^2$ and S the sphere $S^2 \times \{p\}$, where $p \in \partial D^2$. Then attaching the 3-handle gives $W' = B^4$. Let us see what Theorem 3.7 gives in this case. For simplicity, we ignore the decomposition into relative homology classes.

The skein lasagna module of W has the structure of a commutative algebra over \mathbb{Z} , with the multiplication given by putting lasagna fillings side-by-side, in the decomposition

$$(S^2 \times D^2) \cup_{S^2 \times I} (S^2 \times D^2) \cong S^2 \times D^2,$$

where $I \subset \partial D^2$ is an interval. As a \mathbb{Z} -algebra, $\mathcal{S}_0^N(W; \emptyset)$ was computed in [25, Theorem 1.2] to be

$$\mathcal{S}_0^N(W; \emptyset) \cong \mathbb{Z}[A_1, \dots, A_{N-1}, A_0, A_0^{-1}]$$

where A_i comes from the lasagna filling corresponding to the closed surface $S^2 \times \{0\}$, equipped with the standard orientation, and marked with $N - 1 - i$ dots. (As mentioned in Section 2.2, this is equivalent to introducing one input ball intersecting $S^2 \times \{0\}$ in an unknot labeled X^{N-1-i} .)

The cobordism maps

$$\Psi_{I \times Y; \Delta_+}, \Psi_{I \times Y; \Delta_-} : \mathcal{S}_0^N(W; J) \rightarrow \mathcal{S}_0^N(W; \emptyset)$$

are as follows. The unknot J is contained in a ball in the boundary of W (say, a neighborhood of the disk Δ_+). Then, according to [25, Corollary 1.5], we have

$$\mathcal{S}_0^N(W; J) \cong \mathcal{S}_0^N(W) \otimes_{\mathbb{Z}} \text{KhR}_N(J) \cong \mathcal{S}_0^N(W) \otimes_{\mathbb{Z}} (\mathbb{Z}[X]/(X^N)).$$

(Strictly speaking, Corollary 1.5 in [25] is phrased for coefficients in a field \mathbb{k} , due to the fact that its proof requires choosing a basis of $\text{KhR}_N(J)$. In our case, J is the unknot, so $\text{KhR}_N(J)$ is free over \mathbb{Z} , and therefore the same argument applies with coefficients in \mathbb{Z} .)

Both maps $\Psi_{I \times Y; \Delta_+}$ and $\Psi_{I \times Y; \Delta_-}$ correspond to capping the unknot by disks. The first map acts only on the factor $\text{KhR}_N(J)$ and is given by

$$\Psi_{I \times Y; \Delta_+}(v \otimes X^{N-1-i}) = \begin{cases} v & \text{if } i = 0, \\ 0 & \text{if } i = 1, \dots, N-1. \end{cases}$$

A useful picture to have in mind is that we can represent X^{N-1-i} by a dotted disk (with the number of dots specified by the exponent of X), which is completed by Δ_+ to a dotted sphere that bounds a ball in W , and hence can be evaluated to a scalar as shown above. To compute the action of $\Psi_{I \times Y; \Delta_-}$, on the other hand, note that the disk Δ_- completes the dotted disk to a homologically essential dotted sphere, corresponding to a generator in $\mathcal{S}_0^N(W; \emptyset)$:

$$\Psi_{I \times Y; \Delta_-}(v \otimes X^{N-1-i}) = v \cdot A_i.$$

Therefore, taking the coequalizer of the two maps as in Theorem 3.7 boils down to setting

$$A_0 = 1, \quad A_1 = \dots = A_{N-1} = 0$$

in $\mathcal{S}_0^N(W; \emptyset)$. We deduce that

$$\mathcal{S}_0^N(W'; \emptyset) \cong \mathbb{Z}[A_1, \dots, A_{N-1}, A_0, A_0^{-1}]/(A_1, \dots, A_{N-1}, A_0 - 1) \cong \mathbb{Z},$$

which is the known answer for the skein lasagna module of B^4 ; see [27, Example 4.6].

Remark 3.9. Example 3.8 gives an alternate formula for 3-handle attachments. Let us go back to the general setting in this section, with a 3-handle attached to an arbitrary four-manifold W along a sphere S to produce W' , and a framed link $L \subseteq \partial W$ away from S . Observe that $\mathcal{S}_0^N(W, L)$ is naturally a module over the algebra $\mathcal{S}_0^N(S^2 \times D^2; \emptyset)$, with the module action being given by attaching fillings in a neighborhood of the sphere S . It follows from the definitions that

$$\mathcal{S}_0^N(W'; L') \cong \mathcal{S}_0^N(W; L) \otimes_{\mathcal{S}_0^N(S^2 \times D^2; \emptyset)} \mathcal{S}_0^N(B^3 \times I; \emptyset).$$

Here, the algebra $\mathcal{S}_0^N(S^2 \times D^2; \emptyset)$ is the free polynomial ring in $A_1, \dots, A_{N-1}, A_0, A_0^{-1}$ and $\mathcal{S}_0^N(B^3 \times I; \emptyset) = \mathcal{S}_0^N(B^4)$ is \mathbb{Z} as a module over that algebra, where A_0 acts by 1 and the other A_i by 0. We conclude that

$$\mathcal{S}_0^N(W'; L') \cong \mathcal{S}_0^N(W; L) / (A_0 - 1, A_1, \dots, A_N).$$

3.3. Handle decompositions. Let us now specialize the addition of 3-handles to the case where the initial manifold $W = W_2$ is a union of 0-, 1- and 2-handles. We will then have available to us the description of $\mathcal{S}_0^N(W_2; L, \alpha)$ from Section 3.1.

If we attach a 3-handle to W_2 , in terms of Kirby calculus, the attaching sphere S can be represented as a surface Σ (of genus 0, and disjoint from L) with boundary some copies of the K_i 's (the attaching circles for 2-handles). Then S is the union of Σ and (parallel copies of) cores of the 2-handles.

We draw $J \subset S$ as a small unknot away from all K_i , and let Δ_+ be the small disk it bounds. The other hemisphere Δ_- is the complement of Δ_+ in S , and goes over some of the handles. We let

$$\Sigma_- = \Sigma \setminus \Delta_+ \subseteq \Delta_-.$$

This is a surface on ∂W_1 whose boundary is the union of J and several copies of the K_i 's. Let s_i^- be the number of copies of K_i in $\partial \Sigma_-$ that appear with the negative orientation, and s_i^+ the number of those with the positive orientation. We form the vectors

$$s^- = (s_1^-, \dots, s_n^-), \quad s^+ = (s_1^+, \dots, s_n^+).$$

We proceed to describe the maps $\Psi_{I \times Y; \Delta_+, \alpha'}$ and $\Psi_{I \times Y; \Delta_-, \alpha'}$ in this case. By Theorem 3.2 with notation as in (10), the range $\bigoplus_{\alpha \in \langle \alpha' \rangle} \mathcal{S}_0^N(W_2; Z, \alpha)$ of these maps is identified with the direct sum of cabled skein lasagna modules $\bigoplus_{\alpha \in \langle \alpha' \rangle} \underline{\mathcal{S}}_0^{N, \alpha}(W_1; K, L)$. Similarly, their domain is identified with

$$\begin{aligned} \bigoplus_{\alpha \in \langle \alpha' \rangle} \underline{\mathcal{S}}_0^{N, \alpha}(W_1; K, L \cup J) &\cong \bigoplus_{\alpha \in \langle \alpha' \rangle} \underline{\mathcal{S}}_0^{N, \alpha}(W_1; K, L) \otimes \text{KhR}_N(J) \\ &\cong \bigoplus_{\alpha \in \langle \alpha' \rangle} \underline{\mathcal{S}}_0^{N, \alpha}(W_1; K, L) \otimes \mathbb{Z}[X]/(X^N). \end{aligned}$$

We used here the fact that J is split disjoint from all the attaching links for the 2-handles, and therefore each summand that appears in the definition of $\underline{\mathcal{S}}_0^{N, \alpha}(W_1; K, L \cup J)$ splits off a $\text{KhR}_N(J)$ factor; moreover, the equivalence relation is compatible with this splitting.

The map $\Psi_{I \times Y; \Delta_+, \alpha'}$ is now easy to describe. It is induced by capping J with a disk, so it only affects the factor $\text{KhR}_N(J)$, in a standard way. Precisely, we have

$$(11) \quad \Psi_{I \times Y; \Delta_+, \alpha'}(v \otimes X^n) = \begin{cases} v & \text{if } n = N - 1, \\ 0 & \text{if } n = 0, 1, \dots, N - 2, \end{cases}$$

for all $v \in \underline{\mathcal{S}}_0^{N, \alpha}(W_1; K, L)$.

To describe the second map $\Psi_{I \times Y; \Delta_-, \alpha'}$, consider the diagram (12)

$$\begin{array}{ccc}
\bigoplus_{\alpha \in \langle \alpha' \rangle} \mathcal{S}_0^N(W_1; K(k^-, k^+) \cup L \cup J, \alpha) & \xrightarrow{\Psi_{I \times \partial W_1; \Sigma_-, \alpha'}} & \bigoplus_{\alpha \in \langle \alpha' \rangle} \mathcal{S}_0^N(W_1; K(k^- + s^-, k^+ + s^+) \cup L, \alpha) \\
\downarrow & & \downarrow \\
\bigoplus_{\alpha \in \langle \alpha' \rangle} \mathcal{S}_0^{N, \alpha}(W_1; K, L \cup J) & \xrightarrow{\Psi_{I \times \partial W_1; \Sigma_-, \alpha'}} & \bigoplus_{\alpha \in \langle \alpha' \rangle} \mathcal{S}_0^{N, \alpha}(W_1; K, L) \\
\downarrow \cong & & \downarrow \cong \\
\bigoplus_{\alpha \in \langle \alpha' \rangle} \mathcal{S}_0^N(W_2; L \cup J, \alpha) & \xrightarrow{\Psi_{I \times Y; \Delta_-, \alpha'}} & \bigoplus_{\alpha \in \langle \alpha' \rangle} \mathcal{S}_0^N(W_2; L, \alpha).
\end{array}$$

Here, in the top row we wrote (k^-, k^+) for a pair $(r - \alpha^-, r - \alpha^+)$ as in Definition 3.1. The vertical maps from the first to the second row are induced by the inclusion of the summands into the cabled skein lasagna module; cf. Definition 3.1. The vertical maps from the second to the third row are the isomorphisms Φ from Theorem 3.2.

Ignoring the middle dashed arrow for the moment, note that the above diagram commutes. Indeed, by the definition of Φ in the proof of Theorem 3.2, the vertical compositions (from the first to the third row) are given by attaching cores of the 2-handles to lasagna fillings in W_1 . Note that we are attaching more cores on the right; namely, those in the boundary of $\partial \Sigma$, counted by the vectors s^- and s^+ . The horizontal cobordism maps (as defined in Section 2.2) are given by attaching the surface Σ_- (in the top row) and Δ_- (in the bottom row). Because Δ_- is the union of Σ_- and the extra cores of 2-handles counted by s^- and s^+ , the diagram (12) commutes.

Since the bottom vertical arrows in the diagram are isomorphisms, let us now add the middle dashed arrow, given by the map

$$\underline{\Psi}_{I \times \partial W_1; \Sigma_-, \alpha'} := \Phi^{-1} \circ \Psi_{I \times Y; \Delta_-, \alpha'} \circ \Phi.$$

Because (12) commutes, we deduce that this map is induced on the skein lasagna modules by applying the cobordism maps $\Psi_{I \times \partial W_1; \Sigma_-, \alpha'}$ on each summand; this justifies the notation.

Recall that Σ_- is the complement of the disk Δ_+ inside Σ . Thus, we can write the cobordism maps $\Psi_{I \times \partial W_1; \Sigma_-, \alpha'}$ in terms of the maps $\Psi_{I \times \partial W_1; \Sigma(n\bullet), \alpha'}$ associated to the surface Σ with n dots, as in (7):

$$\Psi_{I \times \partial W_1; \Sigma_-, \alpha'}(v \otimes X^n) = \Psi_{I \times \partial W_1; \Sigma(n\bullet), \alpha'}(v).$$

Fixing n , the maps $\Psi_{I \times \partial W_1; \Sigma(n\bullet), \alpha'}$ on various summands in the construction of the skein lasagna module induce a map:

$$\underline{\Psi}_{I \times \partial W_1; \Sigma(n\bullet), \alpha'}: \bigoplus_{\alpha \in \langle \alpha' \rangle} \mathcal{S}_0^{N, \alpha}(W_1; K, L) \rightarrow \bigoplus_{\alpha \in \langle \alpha' \rangle} \mathcal{S}_0^{N, \alpha}(W_1; K, L)$$

such that

$$(13) \quad \underline{\Psi}_{I \times \partial W_1; \Sigma_-, \alpha'}(v \otimes X^n) = \underline{\Psi}_{I \times \partial W_1; \Sigma(n\bullet), \alpha'}(v).$$

We are now ready to give a general formula for the skein lasagna module of a four-manifold decomposed into handles in terms of skein lasagna modules of 1-handlebodies. We will phrase it for an arbitrary number of handles.

Theorem 3.10. *Consider four-manifolds $W_1 \subseteq W_2 \subseteq W_3 \subseteq W_4$ where*

- $W_1 = \natural^m(S^1 \times B^3)$ is the union of m 1-handles;
- W_2 is obtained from W_1 by attaching n two-handles along a framed link K ;
- W_3 is obtained from W_2 by attaching p three-handles along spheres S_1, \dots, S_p ;
- W_4 is obtained from W_3 by attaching some four-handles.

Consider also a framed link $L \subset \partial W_4$. We represent W_4 by a Kirby diagram, viewing $K \cup L$ as a link in ∂W_1 , and the spheres S_i in terms of surfaces Σ_j on ∂W_1 with $\partial \Sigma_j$ consisting of some copies of various components of K (so that S_j is the union of Σ_j and the corresponding cores of the 2-handles).

Given

$$\alpha' \in H_2^L(W_4; \mathbb{Z}) \cong H_2^L(W_3; \mathbb{Z}) \cong H_2^L(W_2; \mathbb{Z}) / ([S_1], \dots, [S_p]),$$

let $\langle \alpha' \rangle$ be the set of all $\alpha \in H_2^L(W_2; \mathbb{Z}) \subseteq \mathbb{Z}^n$ whose equivalence class modulo $([S_1], \dots, [S_p])$ is α' .

Then, the skein lasagna module $\mathcal{S}_0^N(W_4; L, \alpha')$ is isomorphic to the quotient of the direct sum of cabled skein lasagna modules $\bigoplus_{\alpha \in \langle \alpha' \rangle} \mathcal{S}_0^{N, \alpha}(W_1; K, L)$ by the relations

$$(14) \quad \underline{\Psi}_{I \times \partial W_1; \Sigma_j(n\bullet), \alpha'}(v) = 0, \quad n = 0, 1, \dots, N-2,$$

and

$$(15) \quad \underline{\Psi}_{I \times \partial W_1; \Sigma_j((N-1)\bullet), \alpha'}(v) = v$$

for all $v \in \bigoplus_{\alpha \in \langle \alpha' \rangle} \mathcal{S}_0^{N, \alpha}(W_1; K, L)$ and $j = 1, \dots, p$.

Proof. First, note that the addition of 4-handles does not affect the skein lasagna module, in view of Proposition 3.4. Thus, we can consider W_3 instead of W_4 .

The skein lasagna module of L viewed in the boundary of ∂W is given by $\mathcal{S}_0^{N, \alpha}(W_1; K, L)$ according to Theorem 3.2. When we add a 3-handle, we divide by the relations

$$(16) \quad \Psi_{I \times Y; \Delta_+, \alpha'}(v \otimes X^n) = \Psi_{I \times Y; \Delta_-, \alpha'}(v \otimes X^n),$$

as proved in Theorem 3.7. In terms of the identifications Φ from Theorem 3.2, the left hand side of (16) is given by Equation (11), and the right hand side by Equation (13). We thus get relations of the form (14) and (15). The generalization to multiple 3-handles is straightforward. \square

Theorem 3.10 gives a description of an arbitrary skein lasagna module in terms of skein lasagna modules for links in the boundary of $W_1 = \natural^m(S^1 \times B^3)$, and cobordism maps for surfaces in $I \times \partial W_1$. In the next section we will obtain a further reduction to links in S^3 and cobordism maps between them, under the additional constraint of working with field coefficients; see Theorem 4.7.

4. ONE-HANDLES

Consider four-manifolds W and W' , where W' is the result of attaching a finite number of 1-handles to W . The boundary of the cocore of each 1-handle is a 2-dimensional sphere $S^2 \subset \partial W'$ that generically intersects links $L \subset \partial W'$ in a finite set of points. In this section we aim to compute $\mathcal{S}_0^N(W'; L)$ in terms of the invariants $\mathcal{S}_0^N(W; R \cup \bigsqcup_i (T_i \sqcup \overline{T}_i))$ of the four-manifold W and some links $R \cup \bigsqcup_i (T_i \sqcup \overline{T}_i) \subset \partial W$ related to L .

Throughout this section we will work with coefficients in a field \mathbb{k} . Under this assumption KhR_N is strictly monoidal under disjoint union (without Tor terms) and sends mirror links to dual link homologies (without Ext terms). As a consequence, \mathcal{S}_0^N is monoidal under (boundary) connect sum; see [25, Theorem 1.4 and Corollary 7.3]. We leave the investigation of the behavior under more general coefficient rings to future work.

4.1. One-handles away from links. We first consider the case when L is disjoint from the cocores of the 1-handles. Up to a small isotopy, we may even assume that L is disjoint from the entire boundary of the added 1-handles, i.e. that $L \subset \partial W$. As in Proposition 3.4, the corresponding invariants are related by a canonical map and we have:

Lemma 4.1. *The inclusion $i: (W, L) \rightarrow (W', L)$ induces an isomorphism*

$$i_*: \mathcal{S}_0^N(W; L, \mathbb{k}) \xrightarrow{\cong} \mathcal{S}_0^N(W'; L, \mathbb{k})$$

Proof. The proof is a straightforward generalization of the proof of [25, Theorem 1.4], which deals with boundary connected sums. The map i_* is induced by the map sending lasagna fillings of (W, L) to lasagna fillings of (W', L) along the embedding i . The inverse is given on lasagna fillings F in (W', L) by looking at their intersection with a neighborhood of the cocores of all 1-handles. Up to a small isotopy, each such intersection is an identity cobordism on a link $K \subset B^3$. The inverse map is given by replacing it by a sum of pairs of input balls, labelled by basis and dual basis elements of $\text{KhR}_N(K)$ respectively. The resulting linear combination of fillings can be isotoped into W , and is equivalent to the original filling according to the neck-cutting lemma (Lemma 7.2 in [25]). \square

Corollary 4.2. *There are canonical isomorphisms*

$$\mathbb{k} \xrightarrow{\cong} \mathcal{S}_0^N(S^1 \times B^3; \emptyset, \mathbb{k}), \quad \mathbb{k} \xrightarrow{\cong} \mathcal{S}_0^N(S^1 \times S^3, \mathbb{k})$$

each sending $1 \in \mathbb{k}$ to the respective empty lasagna filling.

Proof. The first isomorphism is given by a 1-handle attachment to (B^4, \emptyset) as in Lemma 4.1. The second isomorphism can be proved similarly: Let F be a lasagna filling of $S^1 \times S^3$ and consider its intersection with a fiber $\{x\} \times S^3$. Up to a small isotopy, we may assume that the filling F intersects $\{x\} \times S^3$ transversely (in lasagna sheet, not in input balls) and disjointly from $\{x\} \times \{\text{north pole}\}$. Then for small $\epsilon > 0$, the intersection $F \cap [x - \epsilon, x + \epsilon] \times (S^3 \setminus \text{north pole})$ is an identity cobordism on a link K . We replace this by a sum over pairs of input balls labelled with basis and dual basis elements of $\text{KhR}_N(K)$ respectively. The resulting closed lasagna filling is supported in a single B^4 and can, thus, be identified with a scalar multiple of the empty filling. \square

Remark 4.3. It is instructive to evaluate the inverse to the canonical isomorphisms from Corollary 4.2 on surfaces of revolution generated by links. Any framed, oriented link $K \subset B^3$ or S^3 defines a vegetarian¹ lasagna filling $S^1 \times K$ of $S^1 \times B^3$, which evaluates to a scalar multiple of the empty lasagna filling. It follows from the proofs of Lemma 4.1 and Corollary 4.2 that this scalar is the trace of the identity map on $\text{KhR}_N(K)$. Here it is important to take the Koszul signs in the symmetric monoidal structure on (homologically and quantum) bigraded vector spaces into account. The trace is thus $\text{tr}(\text{Id}_{\text{KhR}_N(K)}) = \chi_{q=1}(\text{KhR}_N(K)) = \pm N^{|\pi_0(K)|}$, i.e. the \mathfrak{gl}_N quantum link polynomial of K , specialized at $q = 1$. More generally, any endocobordism of K defines a lasagna filling of $S^1 \times B^3$ that is a multiple of the empty filling, with coefficient given by the graded trace of the induced endomorphism of $\text{KhR}_N(K)$; see e.g. [16, Section 6], [3, Section 10.1], [7, Theorem D] for related discussions of Lefschetz traces in the case of Khovanov homology.

4.2. Cutting and gluing 1-handles. Consider the process of *cutting a lasagna filling* F of $W_1 = \natural^m(S^1 \times B^3)$ with boundary L along the cocores $C_i \cong \text{pt} \times B^3$ of the 1-handles for $1 \leq i \leq m$. Let us assume that the lasagna sheet Σ of F intersects the cocores transversely in tangles $T_i := \Sigma \cap C_i$. In particular, the link L intersects the belt spheres $S_i := \partial C_i$ geometrically in $2p_i$ points, the boundary points of the tangle T_i . The algebraic intersection numbers are all zero, since L is null-homologous, as witnessed by F . In this way, we obtain a lasagna filling $\text{cut}(F)$ of $W_1 \setminus \bigsqcup_i n(C_i) \cong B^4$ with boundary link

$$L_T := (L \setminus \bigsqcup_i (L \cap S_i)) \cup (T_i \cup \overline{T}_i).$$

The latter is obtained by cutting L open at the $2p_i$ -tuples of boundary points and inserting copies of the tangles T_i and \overline{T}_i , schematically:

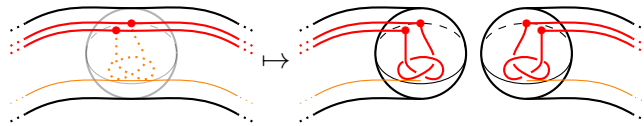

¹A lasagna filling consisting only of a surface, without input *meat balls*.

Of course, the procedure of cutting lasagna fillings does not describe a well-defined map on the level of \mathcal{S}_0^N since it does not respect the skein relations. Instead we consider the reverse operation.

The process of *gluing a lasagna filling* works as follows. Let F' be a lasagna filling of B^4 with boundary link L_T as above; i.e., inside $S^3 = \partial B^4$ we have m pairs of embedded 3-balls $B_i \cup \overline{B}_i$, such that $L_T \cap B_i = T_i$ and $L_T \cap \overline{B}_i = \overline{T}_i$ for $1 \leq i \leq m$. Denote the numbers of boundary points by $2p_i := |\partial T_i|$. Now we attach m 1-handles with core-parallel lasagna sheets $I \times T_i \subset I \times B^3$ along the $B_i \cup \overline{B}_i \cong S^0 \times B^3$ to obtain a lasagna filling of W_1 with boundary L . Since the relations in \mathcal{S}_0^N are local, this induces a map:

$$(17) \quad \text{glue}_{L_T} : \mathcal{S}_0^N(B^4; L_T, \mathbb{k}) \{(\sum_i p_i)(N-1)\} \rightarrow \mathcal{S}_0^N(W_1; L, \mathbb{k})$$

The grading shift is there to compensate the change in Euler characteristic of the surfaces in lasagna fillings upon gluing.

Lemma 4.4. *For every lasagna filling F of $\mathcal{S}_0^N(W_1; L, \mathbb{k})$, there exists a framed $L_T \subset \partial B^4$, such that F is contained in the image of glue_{L_T} .*

Proof. By a small isotopy, we may assume that F satisfies the assumption of the cutting procedure described above. The statement now follows since cutting, albeit ill-defined, is manifestly a right-inverse to gluing. \square

It follows that the gluing maps from (17) assemble to a surjective map from a direct sum of shifts of $\mathcal{S}_0^N(B^4; L_T, \mathbb{k})$ to $\mathcal{S}_0^N(W_1; L, \mathbb{k})$. Here, the sum is indexed by all ways of writing L as a contraction of links L_T obtained by drilling out pairs of tangles $T_i \cup \overline{T}_i$ and resealing the boundary points across the 1-handles. It remains to describe the kernel.

Definition 4.5. *For $p \in \mathbb{N}$ fix a configuration P_p of $2p$ framed points in $S^2 = \partial B^3$, partitioned into two halves with opposite co-orientations. We define a category $\mathcal{S}_0^N(B^3; P_p)$ enriched in bigraded \mathbb{k} -vector spaces with:*

- *objects: framed, oriented tangles T in $(B^3; P_p)$ inducing the given orientation on P_p*
- *morphisms given by*

$$(18) \quad \text{Hom}_{\mathcal{S}_0^N(B^3; P_p, \mathbb{k})}(T_1, T_2) := \text{KhR}_N(T_2 \cup_{P_p} \overline{T}_1, \mathbb{k}) \{p(N-1)\}$$

$$(19) \quad = \mathcal{S}_0^N(B^4; T_2 \cup_{P_p} \overline{T}_1, \mathbb{k}) \{p(N-1)\}$$

with (grading-preserving) composition maps induced in the case of the right-hand side of (18) by the action of merging cobordisms, as described in [27, Section 6.1 (vertical composition of 2-morphisms)], and in the case of (19) induced by the gluing of lasagna fillings of balls.

Lemma 4.6. *Let W be a smooth, oriented, connected, compact four-manifold. Fix $B^3 \subset \partial W$ and consider a link L_1 that intersects B^3 in a tangle T_1 with boundary $\partial T_1 = P_p$, i.e. $L_1 = R \cup_{P_p} T_1$. Now let T_2 be another such tangle and $L_2 = R \cup_{P_p} T_2$, then we have a grading-preserving gluing map*

$$\mathcal{S}_0^N(W; L_1, \mathbb{k}) \otimes \mathcal{S}_0^N(B^4; T_2 \cup_{P_p} \overline{T}_1, \mathbb{k}) \{p(N-1)\} \rightarrow \mathcal{S}_0^N(W; L_2, \mathbb{k}).$$

Moreover, these gluing maps are compatible with composition in $\mathcal{S}_0^N(B^3; P_p, \mathbb{k})$ in the sense that all diagrams of the following type commute:

$$\begin{array}{ccc} \mathcal{S}_0^N(W; L_1, \mathbb{k}) \otimes \mathcal{S}_0^N(B^4; T_2 \cup_{P_p} \overline{T}_1, \mathbb{k}) \otimes \mathcal{S}_0^N(B^4; T_3 \cup_{P_p} \overline{T}_2, \mathbb{k}) \{2p(N-1)\} & & \\ \swarrow & & \searrow \\ \mathcal{S}_0^N(W; L_2, \mathbb{k}) \otimes \mathcal{S}_0^N(B^4; T_3 \cup_{P_p} \overline{T}_2, \mathbb{k}) \{p(N-1)\} & \mathcal{S}_0^N(W; L_1, \mathbb{k}) \otimes \mathcal{S}_0^N(B^4; T_3 \cup_{P_p} \overline{T}_1, \mathbb{k}) \{p(N-1)\} & \\ \searrow & & \swarrow \\ & \mathcal{S}_0^N(W; L_3, \mathbb{k}) & \end{array}$$

Proof. Straightforward on the level of lasagna fillings. The map descends to the quotient since skein relations are local. \square

The statement of Lemma 4.6 can be paraphrased as: the choice of a 3-ball with point configuration P_p in ∂W equips $\mathcal{S}_0^N(W; -, \mathbb{k}) := \bigoplus_L \mathcal{S}_0^N(W, L, \mathbb{k})$ with the structure of a bigraded module for the category $\mathcal{S}_0^N(B^3; P_p)$. (Here the direct sum is taken over all links L that intersect the boundary of the chosen 3-ball in the fixed configuration P_p .)

Theorem 4.7. *Let $W_1 = \mathfrak{h}^m(S^1 \times B^3)$ with a nullhomologous link $L \subset \partial W_1$ in the boundary that intersects the belt spheres of the 1-handles transversely in $2p_i$ points for $1 \leq i \leq m$. Let $R \subset S^3 \setminus \bigsqcup_i (B_i \cup \overline{B}_i)$ denote the tangle obtained from L by cutting open along the belt spheres. Then we have an isomorphism:*

$$\bigoplus_{\substack{\text{tangles } T_i \\ |\partial T_i| = 2p_i}} \text{KhR}_N(R \cup \bigsqcup_i (T_i \sqcup \overline{T}_i), \mathbb{k}) \{(\sum_i p_i)(N-1)\} / \sim \xrightarrow{\cong} \mathcal{S}_0^N(W_1; L, \mathbb{k})$$

where the relation \sim is given by taking coinvariants for the actions of $\mathcal{S}_0^N(B^3; P_{p_i}, \mathbb{k})$, i.e. by identifying the images of the actions

$$\begin{array}{ccc} \text{KhR}_N(R \cup \bigsqcup_i (T_i \sqcup \overline{T}_i), \mathbb{k}) \otimes \bigotimes_i \text{KhR}_N(T'_i \cup T_i, \mathbb{k}) \{p_i(N-1)\} & & \\ \swarrow & & \searrow \\ \text{KhR}_N(R \cup \bigsqcup_i (T_i \sqcup \overline{T}_i), \mathbb{k}) & & \text{KhR}_N(R \cup \bigsqcup_i (T'_i \sqcup \overline{T}_i), \mathbb{k}) \end{array}$$

for all pairs of tangles T_i, T'_i with boundary P_{p_i} . (Here we have omitted a global grading shift.)

Proof. The map is defined by first considering the direct sum of the gluing morphisms

$$\text{KhR}_N(R \cup \bigsqcup_i (T_i \sqcup \overline{T}_i), \mathbb{k}) \{(\sum_i p_i)(N-1)\} \rightarrow \mathcal{S}_0^N(W_1; L, \mathbb{k})$$

from (17). The coinvariants for the actions of $\mathcal{S}_0^N(B^3; P_{p_i}, \mathbb{k})$ clearly lie in the kernel, so we get an induced map from the indicated quotient to $\mathcal{S}_0^N(W_1; L, \mathbb{k})$, which we again call the gluing map. It is surjective by Lemma 4.4, so it remains to prove injectivity.

Let F_1, F_2 be two equivalent linear combinations of lasagna fillings in $\mathcal{S}_0^N(W_1; L, \mathbb{k})$, and let G_1, G_2 be respective preimages under the gluing map. We want to show that G_1 and G_2 are equivalent. Without loss of generality, we may assume that F_1 and F_2 are individual lasagna fillings (rather than linear combinations) and that they differ by a single move as in Lemma 2.1 with the relevant input ball fixed and disjoint from the cocores of the 1-handles in W_1 . If F_1 and F_2 differ by a replacement inside the fixed input ball or an isotopy supported away from the cocores, then G_1 and G_2 are equal in $\text{KhR}_N(R \cup \bigsqcup_i (T_i \sqcup \overline{T}_i), \mathbb{k})$. If F_1 and F_2 differ by an isotopy supported in a neighborhood of the cocores, then G_1 or G_2 differ by an element of the subspace factored out. Since every isotopy of lasagna fillings can be factored in this way, we get that G_1 and G_2 are equivalent. \square

Theorem 4.7 can also be summarized by saying that $\mathcal{S}_0^N(W_1; L, \mathbb{k})$ is computed by the zeroth Hochschild homology of a tensor product of 3-ball categories, namely one for each handle, with coefficients in a bimodule associated to the tangle R that results from L by cutting open along the belt spheres. We will discuss the details of this perspective in a special case in Section 4.3.

Remark 4.8. Similarly to the 2-handle formula from Theorem 3.2, the 1-handle formula from Theorem 4.7 expresses the skein module of the more complicated manifold as a quotient of a (countable) direct sum of invariants of simpler manifolds. A possibly relevant difference, however, is that the 2-handle formula features only finitely many summands with a given shift in quantum grading, whereas this number is infinite for the 1-handle formula.

The skein modules that have been computed using only the 2-handle formula, first and foremost in [25], are locally finite-dimensional, i.e. finite-dimensional in each bidegree. It is an open question whether this is true for all four-manifolds admitting handle decompositions without 1-handles. In the rest of this paper we will see that local finite-dimensionality may fail when 1-handles are present.

Finally we comment on the functoriality of the 1-handle formula from Theorem 4.7. We have seen that $\mathcal{S}_0^N(W_1; L, \mathbb{k})$ for $W_1 = \natural^m(S^1 \times B^3)$ is a colimit of link homologies for links in S^3 , which result from cutting L along belt spheres and inserting pairs of tangles. Now consider a link cobordism $S \subset \partial W_1 \times I =: Z$ from $L \subset W_1$ to $L' \subset W'_1$ where $W'_1 = W_1 \cup Z$. We claim that the induced map

$$\Psi_{Z;S}: \mathcal{S}_0^N(W_1; L, \mathbb{k}) \rightarrow \mathcal{S}_0^N(W'_1; L', \mathbb{k})$$

can also be expressed in terms of cobordism maps between links in S^3 . Recall that the cobordism map $\Psi_{Z;S}$ sends a lasagna filling F of W_1 to the composite lasagna filling $F \cup S$ of $W_1 \cup Z$. In a generic situation, cutting the cocores has the following local model. Here we display the filling F in the inner tube and S in the outer, spherical shell.

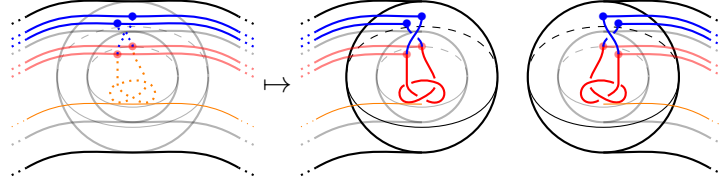

Let S_i denote the tangle in $S^2 \times I$ that occurs as the intersection of S with the i th cocore and $R' \subset S^3 \setminus \bigsqcup_i (B_i \cup \overline{B}_i)$ the tangle obtained from L' by cutting open along the belt spheres of W'_1 . Denote by $2p'_i = |\partial S_i| - 2p_i$ the number of outer boundary point of S_i . Then the cobordism Σ obtained from S by cutting along the annuli, which are the intersection of Z with the cocores of 1-handles in W'_1 , induces a cobordism map:

$$\text{KhR}_N(R \cup \bigsqcup_i (T_i \sqcup \overline{T}_i), \mathbb{k}) \{(\sum_i p_i)(N-1)\} \rightarrow \text{KhR}_N(R' \cup \bigsqcup_i ((S_i \cup T_i) \sqcup \overline{S}_i \cup \overline{T}_i), \mathbb{k}) \{(\sum_i p'_i)(N-1)\}$$

We claim that these components describe $\Psi_{Z;S}$ in terms of the colimit formulas (left-hand sides) from Theorem 4.7. To see this we first observe that the unequal grading shifts guarantee that the components have the same degree as $\Psi_{Z;S}$ (we have $\chi(\Sigma) = \chi(S) + \sum_i (p_i + p'_i)$ and Σ is glued to $\text{cut}(F)$ along p_i interval segments). Next we observe that after composing with the projection-inclusion into the colimit formula for $\mathcal{S}_0^N(W'_1; L', \mathbb{k})$, the resulting map no longer depends on the chosen location of cocores to cut. Moreover, the subspace factored out in the colimit formula for $\mathcal{S}_0^N(W_1; L, \mathbb{k})$ is annihilated by the map thus defined. Thus the components described above define a map $\mathcal{S}_0^N(W_1; L, \mathbb{k}) \rightarrow \mathcal{S}_0^N(W'_1; L', \mathbb{k})$, and by construction this agrees with $\Psi_{Z;S}$.

4.3. Algebraic description of the 3-ball categories and their Hochschild homologies.

Recall the following definition, from e.g. [4].

Definition 4.9. *Let K be a commutative ring and \mathcal{C} be a (small) K -linear category. Then the zeroth Hochschild homology of \mathcal{C} , also called the trace of \mathcal{C} , is defined as the K -module*

$$\text{HH}_0(\mathcal{C}) := \text{Tr}(\mathcal{C}) := \left(\bigoplus_{x \in \text{Ob}(\mathcal{C})} \text{End}_{\mathcal{C}}(x) \right) / \text{Span}\{f \circ g - g \circ f\}$$

where the spanning set for the subspace to be divided out is constructed from all pairs of cyclically composable morphisms, i.e. $f \in \text{Hom}_{\mathcal{C}}(x, y)$ and $g \in \text{Hom}_{\mathcal{C}}(y, x)$ for some $x, y \in \text{Ob}(\mathcal{C})$.

If \mathcal{C} as in Definition 4.9 is not just enriched in K -modules, but M -graded K -modules for some monoid M , then $\text{HH}_0(\mathcal{C})$ inherits the structure of an M -graded K -module. The following is now an immediate consequence of Theorem 4.7 and the Definitions 4.5 and 4.9.

Corollary 4.10. *Let $W_1 = S^1 \times B^3$ and consider the link $S^1 \times P_p$ consisting of $2p$ parallel circles with balanced orientations (that is, with p circles oriented one way and p the other way). Then, we have an isomorphism of bigraded \mathbb{k} -vector spaces:*

$$(20) \quad \mathcal{S}_0^N(S^1 \times B^3; S^1 \times P_p, \mathbb{k}) \cong \mathrm{HH}_0(\mathcal{S}_0^N(B^3; P_p, \mathbb{k}))$$

We now recall some facts about the zeroth Hochschild homology, which we will use to show that the 1-handle formula may compute vector spaces which are not locally finite-dimensional.

Fact 4.11. Any functor $F: \mathcal{C} \rightarrow \mathcal{D}$ of K -linear categories induces natural K -module homomorphism $\mathrm{HH}_0(F): \mathrm{HH}_0(\mathcal{C}) \rightarrow \mathrm{HH}_0(\mathcal{D})$ sending $[f: x \rightarrow x] \mapsto [F(f): F(x) \rightarrow F(x)]$. This is well-defined since $f \circ g - g \circ f \mapsto F(f) \circ F(g) - F(g) \circ F(f)$. If F is an equivalence, then $\mathrm{HH}_0(F)$ is an isomorphism; see e.g. [4].

Fact 4.12. Let $F: \mathcal{C} \rightarrow \mathcal{C}^\oplus$ and $G: \mathcal{C} \rightarrow \mathrm{Kar}(\mathcal{C})$ denote the canonical embeddings of \mathcal{C} into its additive and its idempotent completion, respectively. Then $\mathrm{HH}_0(F)$ and $\mathrm{HH}_0(G)$ are isomorphisms; see e.g. [4, Sections 3.4 and 3.5].

In a slight reformulation of the functoriality results from [8], the tangle invariant underlying the \mathfrak{gl}_N link homology over \mathbb{k} can be described as a 2-functor:

$$[-]: \mathbf{Tang} \rightarrow H^\bullet(\mathbf{Foam}_N^{\mathrm{dg}})$$

We now briefly explain the relevant algebraic structures here.

- As in [27, Definition 6.1] one defines a category \mathbf{TD} of *tangle diagrams*, whose objects are finite words in the alphabet $\{\uparrow, \downarrow\}$ (which encode possible sequences of oriented boundary points for tangles) and whose morphisms are finite words in generating morphisms $\{\mathrm{cup}_i, \mathrm{cap}_i, \mathrm{crossing}_i, \mathrm{crossing}_i^{-1}\}$ (where the index i specifies the strands participating in the generator), that are admissible in the sense that the composite describes a tangle diagram. The composition is concatenation of words. For details see [27, Definition 6.1].
- \mathbf{Tang} is a 2-category whose objects and 1-morphisms are as in \mathbf{TD} . The 2-morphisms are the framed, oriented tangle cobordisms in $[0, 1]^4$ between standard lifts of tangle diagrams to actual tangles in $[0, 1]^3$, considered up to isotopy rel boundary.
- \mathbf{Foam}_N is a (monoidal) 2-category, enriched at the level of 2-morphism spaces in \mathbb{k} -vector spaces and equipped with grading shift functors on 1-morphisms. It has the same objects² as \mathbf{Tang} . The 1-morphisms are (formal direct sums of grading shifts of) \mathfrak{gl}_N webs embedded in $[0, 1]^2$ and the 2-morphisms are (matrices with entries given by) \mathbb{k} -linear combinations of \mathfrak{gl}_N foams embedded in $[0, 1]^3$, modulo certain local relations. For details see [8].
- $\mathbf{Foam}_N^{\mathrm{dg}}$ is the (monoidal) 2-category that is obtained from \mathbf{Foam}_N by replacing its \mathbb{k} -linear Hom-categories by the corresponding dg categories. This means it has the same objects, but the 1-morphisms are now chain complexes formed from 1-morphisms in \mathbf{Foam}_N , where the differentials are given by 2-morphisms in \mathbf{Foam}_N . The 2-morphisms spaces are chain complexes of homologically homogeneous and quantum grading-preserving maps, spanned by 2-morphisms from \mathbf{Foam}_N (not necessarily chain maps). The differential on 2-morphisms is the usual supercommutator with respect to the differential on the source- and target complexes. With respect to this differential the zero cycles are exactly the classical chain maps. There is also an enriched 2-hom in $\mathbf{Foam}_N^{\mathrm{dg}}$, which is assembled from 2-homs between objects shifted in quantum grading.
- $H^\bullet(\mathbf{Foam}_N^{\mathrm{dg}})$ is the cohomology category of $\mathbf{Foam}_N^{\mathrm{dg}}$. It has the same objects and 1-morphisms, but the 2-morphism spaces are now graded \mathbb{k} -modules obtained by taking cohomology. The zeroth cohomology $H^0(\mathbf{Foam}_N^{\mathrm{dg}})$ is also called the homotopy category; its 2-morphisms are chain maps up to homotopy.

²More generally, one can consider labelled oriented points as objects in \mathbf{Foam}_N , but we will not need labels other than 1.

In the following we will also consider enriched 2-homs. For objects s, t and 1-morphisms $A, B: s \rightarrow t$ we define the bigraded \mathbb{k} -modules:

$$(21) \quad H^\bullet(\mathbf{Foam}_N^{\text{dg}})^*(A, B) := \bigoplus_{k \in \mathbb{Z}} \text{Hom}_{H^\bullet(\mathbf{Foam}_N^{\text{dg}})}(A\{k\}, B)$$

Here one grading, the quantum grading, is given by the displayed direct sum, while the other grading, the homological grading, is already internal to $H^\bullet(\mathbf{Foam}_N^{\text{dg}})$. Using the grading shift automorphisms, these enriched 2-homs admit composition maps and thus assemble into a bigraded \mathbb{k} -linear *enriched morphism category* $H^\bullet(\mathbf{Foam}_N^{\text{dg}})^*(s, t)$ whose objects are the 1-morphisms from s to t .

- The functor $\llbracket - \rrbracket$ is the identity on objects. On 1-morphisms it sends a tangle diagram to a chain complex of webs and foams in the way that is usual for \mathfrak{gl}_N link homology, and 2-morphisms, i.e. isotopy classes of tangle cobordisms are sent to the corresponding homotopy classes of chain maps as specified in the functoriality proof in [8].

We recall from [27, Section 6] that the tangle invariant corresponding to the \mathfrak{gl}_N link homology can be organized into a braided monoidal 2-category. Here we give a similar construction of this category \mathbf{T}_N (which was denoted \mathbf{KhR}_N in [27]) by replacing the top morphism layer of \mathbf{Tang} :

- objects are sequences of tangle endpoints, as in \mathbf{TD} and \mathbf{Tang} ,
- 1-morphisms consist of Morse data for tangles, as in \mathbf{TD} and \mathbf{Tang} ,
- 2-morphisms between tangles S and T with equal source and target objects are the bigraded \mathbb{k} -modules computed as the enriched 2-hom $H^\bullet(\mathbf{Foam}_N^{\text{dg}})^*(\llbracket S \rrbracket, \llbracket T \rrbracket)$ from (21) between the \mathfrak{gl}_N chain complexes of the tangles.

As an important special case, one gets for a framed, oriented link L :

$$\text{Hom}_{\mathbf{T}_N}(\emptyset, L) \cong \text{KhR}_N(L).$$

Moreover, if T and S are framed, oriented tangles with endpoints identified, so that we can form the link $T \cup \bar{S}$, then we set $2p = |\partial S| = |\partial T|$ and have:

$$\text{Hom}_{\mathbf{T}_N}(S, T) \cong \text{Hom}_{\mathbf{T}_N}(\emptyset, T \cup \bar{S})\{p(N-1)\} \cong \text{KhR}_N(T \cup \bar{S})\{p(N-1)\}$$

Given a 3-ball B^3 with a set P_p of $2p$ framed, co-oriented points in the boundary, together with a suitable identification of (B^3, P_p) with $([0, 1]^3, s \cup t)$, we associate to it the morphism category $\mathbf{T}_N(s, t)$, whose objects are tangles from s to t . By construction, $\mathbf{T}_N(s, t)$ is equivalent to $S_0^N(B^3; P_p)$ from Definition 4.5. Moreover, $\mathbf{T}_N(s, t)$ can be considered as a full subcategory of the bigraded enriched morphism category $H^\bullet(\mathbf{Foam}_N^{\text{dg}})^*(s, t)$.

Remark 4.13. For $N = 2$ the foam 2-category \mathbf{Foam}_2 can be replaced by the 2-category (or canopolis) of Bar-Natan's dotted cobordisms [3, Section 11.2]; see [6]. The morphism categories of the latter can also be described as categories of finitely-generated graded projective modules for Khovanov's arc rings [18].

4.4. The 3-ball category with two points. Here we consider the categories from Section 4.3 in the special case when the source and target objects consist of a single point $s = t = \{*\}$. In this case, the corresponding morphism category in $\mathbf{Foam}_N^{\text{dg}}$ is known to be equivalent to the dg category of complexes of free graded $R_N := \mathbb{k}[X]/(X^N)$ -modules; see e.g. [32, Lemma 3.35] for an argument in an equivalent setting. We record this equivalence and its consequence on the level of homology:

$$\text{Hom}_{\mathbf{Foam}_N^{\text{dg}}}(*, *) \simeq \text{Ch}_{\text{dg}}(R_N\text{-mod}^{\text{gr.fr.}}), \quad \text{Hom}_{H^\bullet(\mathbf{Foam}_N^{\text{dg}})}(*, *) \simeq H^\bullet(\text{Ch}_{\text{dg}}(R_N\text{-mod}^{\text{gr.fr.}}))$$

Here $R_N\text{-mod}^{\text{gr.fr.}}$ refers to the category of finitely-generated graded free R_N -modules and $\text{Ch}_{\text{dg}}(\mathcal{C})$ refers to the dg category of bounded chain complexes over an additive category \mathcal{C} . Again we will use

a superscript $*$ to refer to the corresponding enriched morphism spaces, computed via the ordinary morphism spaces between shifts of objects as in (21).

Now we specialize to $N = 2$ and classify the indecomposable objects. Setting $R := R_2 = \mathbb{k}[X]/(X^2)$, the isomorphism classes of indecomposable objects (up to shifts in quantum and homological degrees) in $H^\bullet(\text{Ch}_{\text{dg}}(R\text{-mod}^{\text{gr.fr.}}))$ are of the form:

$$C_k := \underline{R} \xrightarrow{X} R\{-2\} \xrightarrow{X} \cdots \xrightarrow{X} R\{-2k\}$$

for $k \geq 0$; see [19, Section 3].

Next we compute the zeroth Hochschild homology of $H^\bullet(\text{Ch}_{\text{dg}}(R\text{-mod}^{\text{gr.fr.}}))$. In principle, there are two possible versions: using the ordinary or the enriched hom; see [5, Section 2.4]. In the case of the ordinary hom, we would obtain a \mathbb{Z} -graded (namely homologically graded) $\mathbb{k}[q^{\pm 1}]$ -module, where q records the action of the auto-equivalence provided by the shift in quantum grading. We will, however, use the enriched hom (indicated by the superscript $*$) to consider the morphism spaces as bigraded. In doing so, one obtains *translation* isomorphisms, which identify an object with all its gradings shifts. More specifically, between an object and its shift, the identity now represents an isomorphism of degree specified by the shift. The zeroth Hochschild homology of the resulting category carries the structure of a bigraded \mathbb{k} -vector space, since the endomorphism q now acts as the identity.

Proposition 4.14. *The bigraded zeroth Hochschild homology of $H^\bullet(\text{Ch}_{\text{dg}}(R\text{-mod}^{\text{gr.fr.}}))^*$ has a basis given by the trace classes $[\text{Id}_{C_l}]$ and $[RX_{C_l}]$ for all $l \geq 0$. The identity morphisms on the complexes C_l for $l \geq 0$ are self-explanatory and their trace classes have bidegree $(0, 0)$. The endomorphism RX_{C_l} is a special case $RX_{C_l} = RX_{C_l}^{(l)}$ of a larger family of endomorphisms $RX_{C_k}^{(l)}$ for $0 \leq l \leq k$ of the following form:*

$$\begin{array}{cccccccccccccccc} \underline{R} & \xrightarrow{X} & \cdots & \xrightarrow{X} & R\{-2l\} & \xrightarrow{X} & \cdots & \xrightarrow{X} & R\{-2k\} & \xrightarrow{0} & \cdots & \xrightarrow{0} & \cdots & \xrightarrow{0} & 0 \\ & & & & & & & & & & & & & & & \downarrow X \\ 0 & \xrightarrow{0} & \cdots & \xrightarrow{0} & R\{-2l-2\} & \xrightarrow{X} & \cdots & \xrightarrow{X} & R\{-2k-2\} & \xrightarrow{X} & \cdots & \xrightarrow{X} & R\{-2k-2l-2\} \end{array}$$

where the only non-zero component is at $R\{-2k\}$ (which may coincide with $R\{-2l\}$ if $k = l$). The trace class of the morphism $RX_{C_k}^{(l)}$ has bidegree $(l, 2l+2)$. (RX stands for shift right and apply X .)

Proof. We abbreviate $\mathcal{C}' := H^\bullet(\text{Ch}_{\text{dg}}(R\text{-mod}^{\text{gr.fr.}}))^*$. Let \mathcal{C} denote the full subcategory generated by the indecomposable objects C_k . By Fact 4.11 and the discussion of the beginning of the section, it suffices to compute the bigraded zeroth Hochschild homology of \mathcal{C} . To this end, we study closed homogeneous endomorphisms of the objects C_k and trace relations between them.

We note that the components of a chain map between shifts of such objects can have quantum degree zero or two (a scalar multiple of Id_R or X_R). Since the differential in every complex is of quantum degree two, this means that closed morphisms with components of quantum degree zero are homotopic if and only if they are equal.

First we investigate the chain maps between shifts of objects C_l with components of quantum degree zero. For positive homological shifts (right shift) there are simply no closed morphisms, i.e. no chain maps. In shift zero we have the identity on every C_l (which does not factor through any C_m with $m \neq l$) and for negative homological shifts we have closed maps that factor into a composite of closed maps through a shift of a C_m with $m < l$ (by induction, one can show that their trace classes actually vanish). Thus in bidegree $(0, 0)$ we have a basis of trace classes $[\text{Id}_{C_l}]$ for $l \geq 0$.

Second we are interested in chain maps between shifts of objects C_l with components of quantum degree two. In negative homological shifts (left shift) all such maps are nullhomotopic. In non-negative homological shift, every such map is homotopic to a scalar multiple of $RX_{C_k}^{(l)}$. However,

one easily checks that the trace class of $RX_{C_k}^{(l)}$ equals the trace class of $\pm RX_{C_l}^{(l)}$. Since these have bidegree $(l, 2l + 2)$ in the enriched End of C_l , we see that they are linearly independent. \square

Note that the bigraded zeroth Hochschild homology of $H^\bullet(\text{Ch}_{\text{dg}}(R\text{-mod}^{\text{gr.fr.}}))^*$ is *not* locally finite-dimensional! It is of countable dimension in bidegree $(0, 0)$ with a basis given by $[\text{Id}_{C_l}]$ for $l \geq 0$. Nevertheless, we have:

Proposition 4.15. *The bigraded vector spaces*

$$\mathcal{S}_0^2(S^1 \times B^3; S^1 \times P_1, \mathbb{k}) \cong \text{HH}_0(\mathcal{S}_0^2(B^3; P_1, \mathbb{k})) \cong \text{HH}_0(\mathbf{T}_2(*, *))$$

are four-dimensional, and in particular, locally finite-dimensional.

Proof. We have already explained the two isomorphisms. We now need to understand the essential image of $\mathbf{T}_2(*, *)$ under the full embedding into $H^\bullet(\text{Ch}_{\text{dg}}(R\text{-mod}^{\text{gr.fr.}}))^*$. We claim that the invariant of any $(1, 1)$ -tangle decomposes into (shifts of) the indecomposable summands C_0 and C_1 , but never C_l for $l \geq 2$. Provided this claim holds, we can compute $\text{HH}_0(\mathbf{T}_2(*, *))$ as the Hochschild homology of the full additive subcategory of $H^\bullet(\text{Ch}_{\text{dg}}(R\text{-mod}^{\text{gr.fr.}}))^*$ generated by C_0 and C_1 , and this again is isomorphic to the Hochschild homology of the full subcategory on the two objects C_0 and C_1 . Here we use that the zeroth Hochschild homology is preserved under proceeding to the additive and idempotent completion; see Fact 4.12. Following the same arguments as in Proposition 4.14, we see that it is 4-dimensional, spanned by $[\text{Id}_{C_l}]$ and $[RX_{C_l}]$ for $l \in \{0, 1\}$.

The key idea to prove the claim is that all complexes appearing in Khovanov homology come from complexes over $\mathbb{k}[X]$ by setting $X^2 = 0$ (though certainly not all complexes over $\mathbb{k}[X]/(X^2)$ have this property). Indeed, one can use equivariant Khovanov homology, defined over the ring $\mathbb{k}[X, \alpha]/(X^2 - \alpha) \cong \mathbb{k}[X] =: R'$ to simplify the complex of a $(1, 1)$ -tangle into a complex of graded free $\mathbb{k}[X]$ -modules. These decompose, up to homotopy equivalence and shift, into chain complexes of the form

$$C^0 := 0 \xrightarrow{0} \underline{R'} \xrightarrow{0} 0, \quad \text{and} \quad C^k := 0 \xrightarrow{0} \underline{R'} \xrightarrow{X^k} R'\{-2k\} \xrightarrow{0} 0 \quad \text{for } k \geq 1$$

Upon reducing to the ordinary Khovanov theory by tensoring with $\mathbb{k}[X]/(X^2)$ over $\mathbb{k}[X]$, these complexes decompose into (shifts of) copies of C_0 and C_1 . \square

Remark 4.16. A strong version of the so-called knight move conjecture posited that the complex of any long knot decomposes (up to homotopy equivalence) into one shifted copy of C_0 and some number of copies of C_1 ; see [19, Conjecture 1]. The argument in the previous proof shows that this can fail only due to the presence of *more than one* shifted copy of C_0 . Three copies of C_0 can be detected in the counterexample to the knight move conjecture found by Manolescu–Marengon [24].

Remark 4.17. One can also consider analogs of the skein modules \mathcal{S}_0^N based on equivariant or deformed versions of \mathfrak{gl}_N homology. For example, in one common choice for $N = 2$ one works over $R' = \mathbb{k}[X, \alpha]/(X^2 - \alpha)$. We can also try to compute the bigraded zeroth Hochschild homology of the 3-ball category with two points and of its ambient category $H^\bullet(\text{Ch}_{\text{dg}}(R'\text{-mod}^{\text{gr.fr.}}))^*$ in this setting. We have already listed the indecomposable of the latter above: the chain complexes C^k . For $k \geq 1$ the enriched isomorphism algebra of the complex C^k is isomorphic to $R'[\eta]/(X^k = 0)$ where η is of bidegree $(1, 2k)$. The trace classes of η and its multiples are zero. Moreover, the trace class of X^x is zero for every $x > 0$. This leaves the trace classes of the identities of C^k for $k \geq 0$ and the trace class of X_{C^0} as linearly independent — the zeroth Hochschild homology is not locally finite-dimensional. However, it is currently not known which C^k appear in complexes of $(1, 1)$ -tangles. A copy of C^3 appears in [24].

4.5. The 3-ball category with four or more points. We claim that the 3-ball categories with $2p \geq 4$ points have zeroth Hochschild homologies that are no longer locally finite-dimensional. Again we restrict to the case of $N = 2$ and work over a perfect field \mathbb{k} . Our strategy is to give a lower bound for the dimension of the zeroth Hochschild homology in terms of the split Grothendieck group. We briefly recall the relevant notions and results.

Definition 4.18. *Let \mathcal{C} be an additive category. The split Grothendieck group of \mathcal{C} is defined as:*

$$K_0(\mathcal{C}) := \frac{\text{Span}_{\mathbb{Z}}\{\text{isomorphism classes } [x] \text{ of objects in } \mathcal{C}\}}{([x \oplus y] = [x] + [y] \mid x, y \in \text{Ob}(\mathcal{C}))}$$

Definition 4.19. *A K -linear additive category \mathcal{C} is called Krull–Schmidt if every object decomposes uniquely into a finite direct sum of indecomposable objects with local endomorphism rings.*

The following is clear from the definition:

Proposition 4.20. *For a Krull–Schmidt category, the split Grothendieck group is a free abelian group on the isomorphism classes of indecomposable objects in \mathcal{C} .*

Definition 4.21. *For a K -linear additive category \mathcal{C} , the Chern character is the K -linear map*

$$h_{\mathcal{C}}: K_0(\mathcal{C}) \otimes_{\mathbb{Z}} K \rightarrow \text{HH}_0(\mathcal{C}), \quad [x] \otimes 1 \mapsto [\text{Id}_x: x \rightarrow x]$$

Proposition 4.22 (Proposition 2.4 in [5]). *If $K = \mathbb{k}$ is a perfect field and \mathcal{C} is Krull–Schmidt with a finite-dimensional endomorphism algebra for each indecomposable object, then the Chern character $h_{\mathcal{C}}$ is injective.*

Using these tools, we can now prove:

Theorem 4.23. *Let $p \geq 2$. Then $\mathcal{S}_0^2(S^1 \times B^3; S^1 \times P_p, \mathbb{k})$ is infinite-dimensional in bidegree $(0, 0)$.*

Proof. We let $s = t = p$ points and again have isomorphisms

$$\mathcal{S}_0^2(S^1 \times B^3; S^1 \times P_p, \mathbb{k}) \cong \text{HH}_0(\mathcal{S}_0^2(B^3; P_p, \mathbb{k})) \cong \text{HH}_0(\mathbf{T}_2(s, t))$$

and we consider the category $\mathbf{T}_2(s, t)$ as a full subcategory of the enriched morphism category $H^\bullet(\mathbf{Foam}_2^{\text{dg}})^*(s, t)$.

The \mathbb{k} -linear, additive category $H^\bullet(\mathbf{Foam}_2^{\text{dg}})^*(s, t)$ is Krull–Schmidt and hence idempotent complete; see e.g. the discussion in [30, Sections 4.5, 4.8] based on Bar-Natan’s category, which is equivalent to \mathbf{Foam}_2 by [6].

Now $\text{Kar}(\mathbf{T}_2(s, t))^{\oplus}$ may be considered as an additive, idempotent complete full subcategory of $H^\bullet(\mathbf{Foam}_2^{\text{dg}})^*$; it is thus itself Krull–Schmidt. We have $\text{HH}_0(\mathbf{T}_2(s, t)) \cong \text{HH}_0(\text{Kar}(\mathbf{T}_2(s, t))^{\oplus})$ by Fact 4.12. Therefore, it suffices to compute its zeroth Hochschild homology of $\text{Kar}(\mathbf{T}_2(s, t))^{\oplus}$.

It is straightforward to check that the objects of $\text{Kar}(\mathbf{T}_2(s, t))^{\oplus}$ have finite-dimensional endomorphism algebras, and since \mathbb{k} is perfect, the Chern character

$$h: K_0(\text{Kar}(\mathbf{T}_2(s, t))^{\oplus}) \otimes_{\mathbb{Z}} \mathbb{k} \rightarrow \text{HH}_0(\text{Kar}(\mathbf{T}_2(s, t))^{\oplus})$$

is injective; see Proposition 4.22. To prove that $\mathcal{S}_0^2(S^1 \times B^3; S^1 \times P_p, \mathbb{k})$ is infinite-dimensional in bidegree $(0, 0)$, it is thus sufficient to show that $K_0(\text{Kar}(\mathbf{T}_2(s, t))^{\oplus}) \otimes_{\mathbb{Z}} \mathbb{k}$ is infinite-dimensional.

Moreover, $K_0(\text{Kar}(\mathbf{T}_2(s, t))^{\oplus})$ is free abelian on the isomorphism classes of its indecomposable objects; cf. Proposition 4.20. Thus, we will be done once we can exhibit infinitely many indecomposable and pairwise non-isomorphic complexes appearing as (direct summands in) tangle complexes.

We will see that such complexes can be constructed as invariants of braids. Clearly, for $p \geq 2$ there are infinitely many braids on p strands. Moreover, the braid complexes are invertible under tensoring with the complex for the respective inverse braid. Since the complex of the trivial braid is indecomposable (its endomorphism algebra $(\mathbb{k}[X]/(X^2))^{\otimes p}$ is local), so are the complexes for all

other braids. It is also known that all braid complexes are pairwise non-isomorphic. This can e.g. be deduced from the faithfulness of the braid group action of Khovanov–Seidel [22]. For us, however, it is enough to consider infinitely many braids that are powers of a single Artin braid generator. For these complexes it is straightforward to check by hand that they are pairwise non-isomorphic. \square

Observe that Theorem 1.5 from the introduction is a combination of Corollary 4.2, Proposition 4.15, and Theorem 4.23.

4.6. Comparison with the Rozansky–Willis invariant. In [31], Rozansky defined a Khovanov-type homology theory for (null-homologous) links in $S^1 \times S^2$. His construction was generalized by Willis in [33] to null-homologous links in $Y = \#^m(S^1 \times S^2)$ for any m . We will denote the Rozansky–Willis homology of $L \subset Y$ by $H_{\text{RW}}^{*,*}(L)$. Just like the skein lasagna module $\mathcal{S}_0^2(W_1, L)$, the invariant $H_{\text{RW}}^{*,*}(L)$ can be computed from a Kirby diagram for $W_1 = \natural^m(S^1 \times B^3)$ including the link L , so it is a natural question whether they are related.

The first observation is that the two invariants are not always isomorphic. Indeed, in any specific bidegree, $H_{\text{RW}}^{*,*}(L)$ is defined as the Khovanov homology of the link in S^3 obtained from L by adding sufficiently many twists in place of the 1-handles. It follows that $H_{\text{RW}}^{*,*}(L)$ has finite rank in each bidegree, whereas this may not hold for $\mathcal{S}_0^2(W_1, L)$, as we have seen in Theorem 4.23. Another concrete example is for $m = 1$, where $L = S^1 \times P_1$ yields a 4-dimensional lasagna skein module according to Proposition 4.15, but $H_{\text{RW}}^{*,*}(L) \cong \text{HH}_\bullet(\mathbb{k}[X]/(X^2))$ is infinite-dimensional.

However, $H_{\text{RW}}^{*,*}(L)$ and $\mathcal{S}_0^2(W_1, L)$ are conceptually similar, as both arise as the Hochschild homology of a chain complex associated to a tangle T that closes to the link L :

- $H_{\text{RW}}^{*,*}(L)$ is computed as the Hochschild homology of a dg bimodule (for a tensor product of m of Khovanov’s arc rings) associated to the tangle T , as defined for $m = 1$ by Khovanov in [18] and extended by parabolic induction to $m > 1$. Here the homological degree of the dg bimodule gets mixed with the Hochschild degree, and so the resulting invariant is a bigraded vector space.
- $\mathcal{S}_0^2(W_1, L)$ can be computed via Theorem 4.7 (and for $m = 1$ even more concretely in Corollary 4.10) as the zeroth Hochschild homology of an equivalent dg bimodule; see Remark 4.13 for the comparison. In fact, the higher blob homology from [27], which does not play a role for skein lasagna modules, corresponds to higher Hochschild homology. The main difference, however, is that the dg bimodule is not considered as an object of a dg or triangulated category, but of the *linear* cohomology category. Accordingly, the full blob homology is triply-graded, with the blob/Hochschild grading separated from the homological grading.

Based on this comparison, one may expect $\mathcal{S}_0^2(W_1, L)$ and, more generally, the full blob homology $\mathcal{S}_*^N(W_1; L)$ to appear on the E_2 page of a spectral sequence converging to $H_{\text{RW}}^{*,*}(L)$. Suppose that one can find a suitable projective resolution in terms of tangle complexes, which simultaneously allows the computation of blob homology as well as the dg version of Hochschild homology. Then, by tensoring with the dg bimodule associated to the tangle, one obtains a double complex of (quantum) graded vector spaces, where the vertical differential carries Hochschild degree and the horizontal differential carries homological degree. The homology of the total complex would compute $H_{\text{RW}}^{*,*}(L)$. To obtain $\mathcal{S}_0^2(W_1, L)$, one first takes homology in the rows (thus computing the Khovanov homologies of links of the form $T_i \cup \bar{T}$ where T_i appears in the resolution), and only then the zeroth homology of the induced differential coming from the resolution. We will not pursue this comparison further in the present paper, but remark that there is precedent for interesting invariants appearing on E_2 pages of spectral sequences that come from separating Hochschild and homological degrees, namely the triply-graded HOMFLYPT link homology; see [29, Section 6].

In general, one does not expect a map from the E_2 page of a spectral sequence to its E_∞ page. However, since $\mathcal{S}_0^2(W_1, L)$ appears as the lowest row on the E_2 page, the above discussion suggests

the existence of a natural map

$$\mathcal{S}_0^2(W_1, L) \rightarrow H_{\text{RW}}^{*,*}(L).$$

In the following we propose a candidate for such a map.

In Willis's construction of $H_{\text{RW}}^{*,*}(L)$, we represent $\partial W_1 = Y$ by m pairs of spheres in the plane, with the spheres in each pair being identified (that is, we add a handle). This is the same as the usual Kirby diagram of W_1 . The link L may intersect each handle a number of times, as in this picture:



Let $L(n_1, \dots, n_m)$ be the link in S^3 obtained from L by inserting n_i full twists in place of the i^{th} handle, as shown here:

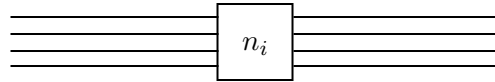

The homology $H_{\text{RW}}^{*,*}(L)$ can be computed as the Khovanov homology of the link $L(n_1, \dots, n_m)$ for $n_i \gg 0$, with some suitable shifts in grading. Note that $L(n_1, \dots, n_m)$ depends on the choice of a path between the attaching spheres of each 1-handle; however, it can be shown that $H_{\text{RW}}^{*,*}(L)$ is independent of these choices up to isomorphism.

Consider now the skein lasagna module $\mathcal{S}_0^2(W_1, L)$. Let us attach an n_i -framed 2-handle through the i^{th} 1-handle:

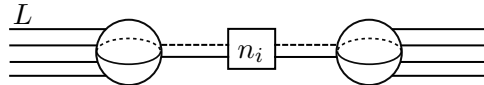

The 2-handles cancel the corresponding 1-handles, so the result is a Kirby diagram for B^4 , whose boundary is S^3 . The link L becomes $L(n_1, \dots, n_m) \subset S^3$, as can be seen by doing a series of handle slides of the arcs of L over the 2-handle:

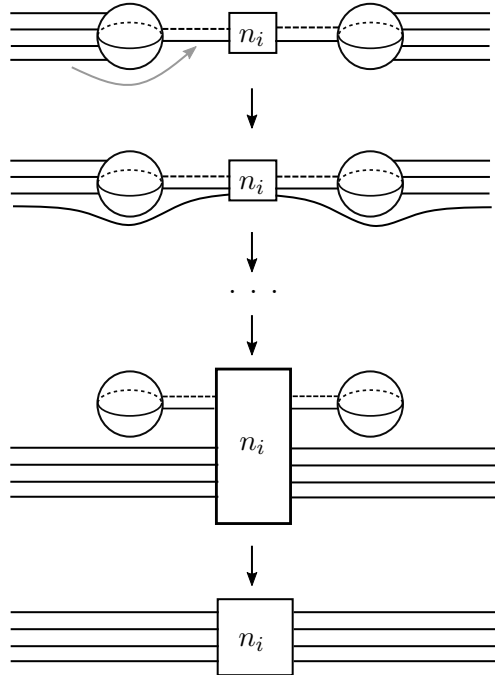

where in the last step we cancelled the handles. (Compare Figure 5.13 in [10].)

The 2-handle attachments give a cobordism Z from $Y = \#^m(S^1 \times S^2)$ to S^3 . There is also an embedded annular cobordism $S \subset Z$ from L to $L(n_1, \dots, n_m)$. As discussed in Section 2.2, these cobordisms induce a map on skein lasagna modules:

$$\Psi_{Z;S} : \mathcal{S}_0^2(W_1; L) \rightarrow \mathcal{S}_0^2(B^4; L(n_1, \dots, n_m)) \cong \text{Kh}(L(n_1, \dots, n_m)).$$

Our conjecture is that these maps stabilize as $n_i \rightarrow \infty$, giving a well-defined morphism from $\mathcal{S}_0^2(W_1, L)$ to $H_{\text{RW}}^{*,*}(L)$.

4.7. Speculations on homotopy coherent four-manifold invariants. We expect that the above E_2 -page-of-spectral-sequence relationship between \mathcal{S}_0^2 and $H_{\text{RW}}^{*,*}$ for $(\natural^m(S^1 \times B^3), L)$ generalizes to (W, L) for arbitrary four-manifolds W and links L . We give a brief sketch of the reasoning below.

Recall that the Khovanov–Rozansky invariants upon which \mathcal{S}_0^N is built assign chain complexes to links L and chain maps to link cobordisms, but it is not known that this assignment is functorial (or even well-defined) at the level of complexes. The proof that the homology of these complexes is functorial in the appropriate sense involves showing that certain chain maps are homotopic. If this result could be strengthened to show that certain homotopies between the chain maps are themselves 2nd-order homotopic, and so on for all higher orders, then one could construct a functorial assignment of chain complexes to links in S^3 and chain maps to link cobordisms.

Let us assume that these conjectured “fully coherent” \mathfrak{gl}_N chain complexes for links exist. Then, they can be repackaged as a pivotal $(\infty, 4)$ -category (with composition maps defined in terms of link cobordisms, as in [27]). This $(\infty, 4)$ -category can in turn be fed into the machinery of Section 6.3 of [26] (which is closely related to topological chiral homology [23] and factorization homology [1, 2]). The result is a chain-complex-valued invariant $\mathcal{S}_\infty^N(W, L)$. Its construction involves taking a homotopy colimit of a poset built out of the set of all ball decompositions of W and refinement relationships between these ball decompositions. Concretely, we construct a double complex, with horizontal differentials coming from the \mathfrak{gl}_N complexes of links, and vertical differentials coming from the combinatorics of refining ball decompositions of W . There is a spectral sequence associated to this double complex, which is itself an invariant of (W, L) .

The E_2 page of this spectral sequence involves first taking homology in the horizontal direction, then computing homology with respect to vertical differentials. It is easy to see that this E_2 page is exactly the blob homology $\mathcal{S}_*^N(W; L)$ assigned to (W, L) in [27] (i.e. by taking KhR homology early instead of working with the \mathfrak{gl}_N complex). (In this paper we have focused on blob-degree zero, corresponding to the bottom row of the E_2 page of the spectral sequence.)

When $W_1 = \natural^m(S^1 \times B^3)$ and $N = 2$, we expect the total homology of $\mathcal{S}_\infty^N(W_1, L)$ to coincide with the Rozansky–Willis invariants. The Hochschild differentials of the previous subsection should be (homotopy equivalent to) special cases of the vertical differentials above.

REFERENCES

- [1] D. Ayala and J. Francis, *Factorization homology of topological manifolds*, J. Topol., **8**(2015), no. 4, 1045–1084.
- [2] D. Ayala, J. Francis, and H. L. Tanaka, *Factorization homology of stratified spaces*, Selecta Math. (N.S.), **23**(2017), no. 1, 293–362.
- [3] D. Bar-Natan, *Khovanov’s homology for tangles and cobordisms*, Geom. Topol., **9**(2005), 1443–1499.
- [4] A. Beliakova, K. Habiro, A. D. Lauda, and M. Živković, *Trace decategorification of categorified quantum \mathfrak{sl}_2* , Math. Ann., **367**(2017), no. 1-2, 397–440.
- [5] A. Beliakova, K. Habiro, A. D. Lauda, and B. Webster, *Current algebras and categorified quantum groups*, J. Lond. Math. Soc. (2), **95**(2017), no. 1, 248–276.
- [6] A. Beliakova, M. Hogancamp, K. Karol Putyra, and S. M. Wehrli, *On the functoriality of $sl(2)$ tangle homology*, arXiv:1903.12194, 2019.
- [7] A. Beliakova, K. Karol Putyra, and S. M. Wehrli, *Quantum link homology via trace functor I*, Invent. Math., **215**(2019), no. 2, 383–492.

- [8] M. Ehrig, D. Tubbenhauer, and P. Wedrich, *Functoriality of colored link homologies*, Proc. Lond. Math. Soc. (3), **117**(2018), no. 5, 996–1040.
- [9] B. Elias and Y. Qi, *An approach to categorification of some small quantum groups II*, Adv. Math., **288**(2016), 81–151.
- [10] R. E. Gompf and A. I. Stipsicz, *4-manifolds and Kirby calculus*, volume 20 of *Graduate Studies in Mathematics*, American Mathematical Society, Providence, RI, 1999.
- [11] E. Gorsky and P. Wedrich, *Evaluations of annular Khovanov–Rozansky homology*, arXiv:1904.04481, 2019.
- [12] J. E. Grigsby, A. M. Licata, and S. M. Wehrli, *Annular Khovanov homology and knotted Schur–Weyl representations*, Compos. Math., **154**(2018), no. 3, 459–502.
- [13] S. Gukov, D. Pei, P. Putrov, and C. Vafa, *BPS spectra and 3-manifold invariants*, J. Knot Theory Ramifications, **29**(2020), no. 2, 2040003, 85.
- [14] S. Gukov, P. Putrov, and C. Vafa, *Fivebranes and 3-manifold homology*, J. High Energy Phys., (2017), no. 7, 071, front matter+80.
- [15] M. Hogancamp, D. E. V. Rose, and P. Wedrich, *A Kirby color for Khovanov homology*, Preprint, arXiv:2210.05640, 2022.
- [16] M. Jacobsson, *An invariant of link cobordisms from Khovanov homology*, Algebr. Geom. Topol. **4**(2004) 1211–1251.
- [17] M. Khovanov, *A categorification of the Jones polynomial*, Duke Math. J., **101**(2000), no. 3, 359–426.
- [18] M. Khovanov, *A functor-valued invariant of tangles*, Algebr. Geom. Topol., **2**(2002), 665–741.
- [19] M. Khovanov, *Patterns in knot cohomology. I*, Experiment. Math., **12**(2003), no. 3, 365–374.
- [20] M. Khovanov and Y. Qi, *An approach to categorification of some small quantum groups*, Quantum Topol., **6**(2015), no. 2, 185–311.
- [21] M. Khovanov and L. Rozansky, *Matrix factorizations and link homology*, Fund. Math., **199**(2008), no. 1, 1–91.
- [22] M. Khovanov and P. Seidel, *Quivers, Floer cohomology, and braid group actions*, J. Amer. Math. Soc., **15**(2002), no. 1, 203–271.
- [23] J. Lurie, *Higher algebra*, <https://www.math.ias.edu/~lurie/papers/HA.pdf>, 2017.
- [24] C. Manolescu and M. Marengon, *The knight move conjecture is false*, Proc. Amer. Math. Soc., **148**(2020), no. 1, 435–439.
- [25] C. Manolescu and I. Neithalath, *Skein lasagna modules for 2-handlebodies*, Preprint, arXiv:2009.08520v1, 2020.
- [26] S. Morrison and K. Walker, *Blob homology*, Geom. Topol., **16**(2012), no. 3, 1481–1607.
- [27] S. Morrison, K. Walker, and P. Wedrich, *Invariants of 4-manifolds from Khovanov–Rozansky link homology*, Preprint, arXiv:1907.12194v3, 2019.
- [28] Y. Qi, L.-H. Robert, J. Sussan, and E. Wagner, *A categorification of the colored Jones polynomial at a root of unity*, Preprint, arXiv:2111.13195v1, 2021.
- [29] J. Rasmussen, *Some differentials on Khovanov–Rozansky homology*, Geom. Topol., **19**(2015), no. 6, 3031–3104.
- [30] J. Rasmussen, *Knots, polynomials, and categorification*, in *Quantum field theory and manifold invariants*, Amer. Math. Soc., Providence, RI, volume 28 of *IAS/Park City Math. Ser.*, pp. 77–170, 2021.
- [31] L. Rozansky, *A categorification of the stable $SU(2)$ Witten–Reshetikhin–Turaev invariant of links in $S^2 \times S^1$* , Preprint, arXiv:1011.1958v1, 2010.
- [32] P. Wedrich, *Exponential growth of colored HOMFLY–PT homology*, Adv. Math., **353**(2019), 471–525.
- [33] M. Willis, *Khovanov homology for links in $\#^r(S^2 \times S^1)$* , Michigan Math. J., **70**(2021), no. 4, 675–748.
- [34] E. Witten, *Fivebranes and knots*, Quantum Topol., **3**(2012), no. 1, 1–137.

DEPARTMENT OF MATHEMATICS, STANFORD UNIVERSITY, STANFORD, CA 94305, USA
 Email address: cm5@stanford.edu

MICROSOFT STATION Q, SANTA BARBARA, CA 93106, USA
 Email address: kevin@canyon23.net

FACHBEREICH MATHEMATIK, UNIVERSITÄT HAMBURG, BUNDESSTRASSE 55, 20146 HAMBURG, GERMANY
 Email address: paul.wedrich@uni-hamburg.de