

The Diverse Roles of the Hippocampus: Navigation, Creativity, Empathy, [. . . .]

Tom Dean, Stanford, May 4, 2021

Acknowledgements: Francis Eugene Lewis, Yash Savani, Chaofei Fan, Randy O'Reilly, Jay McClelland, Dharshan Kumaran

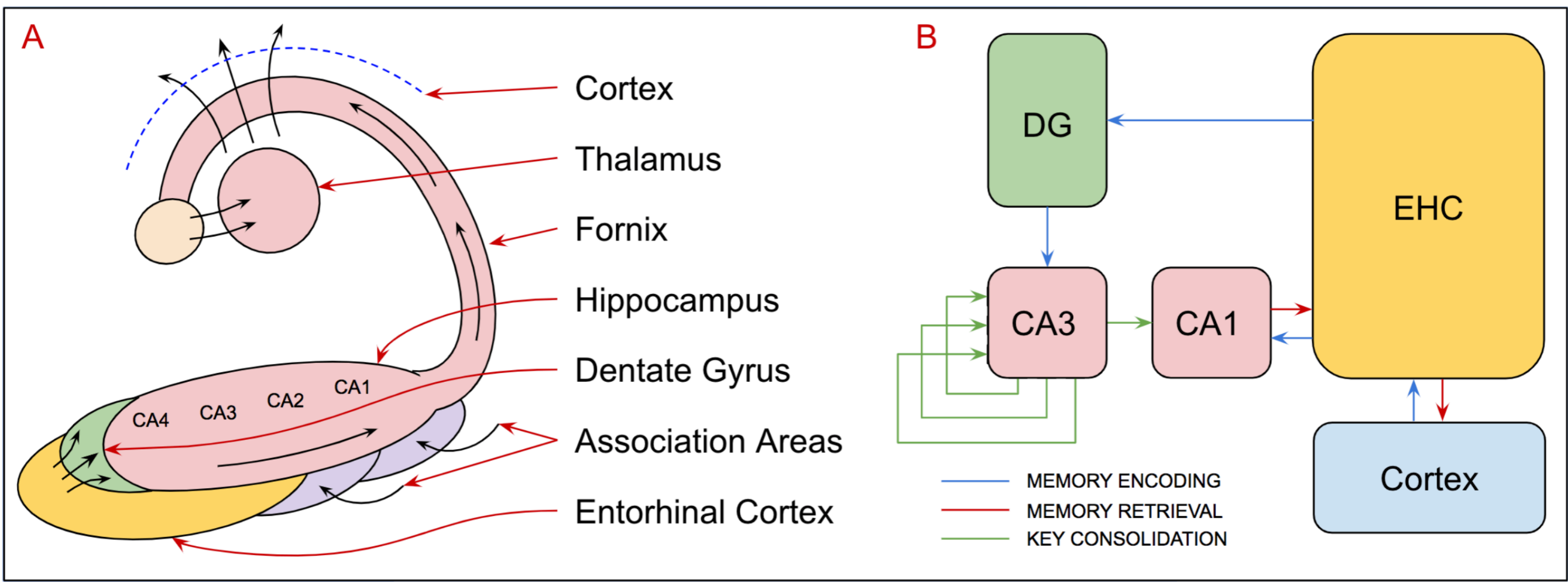
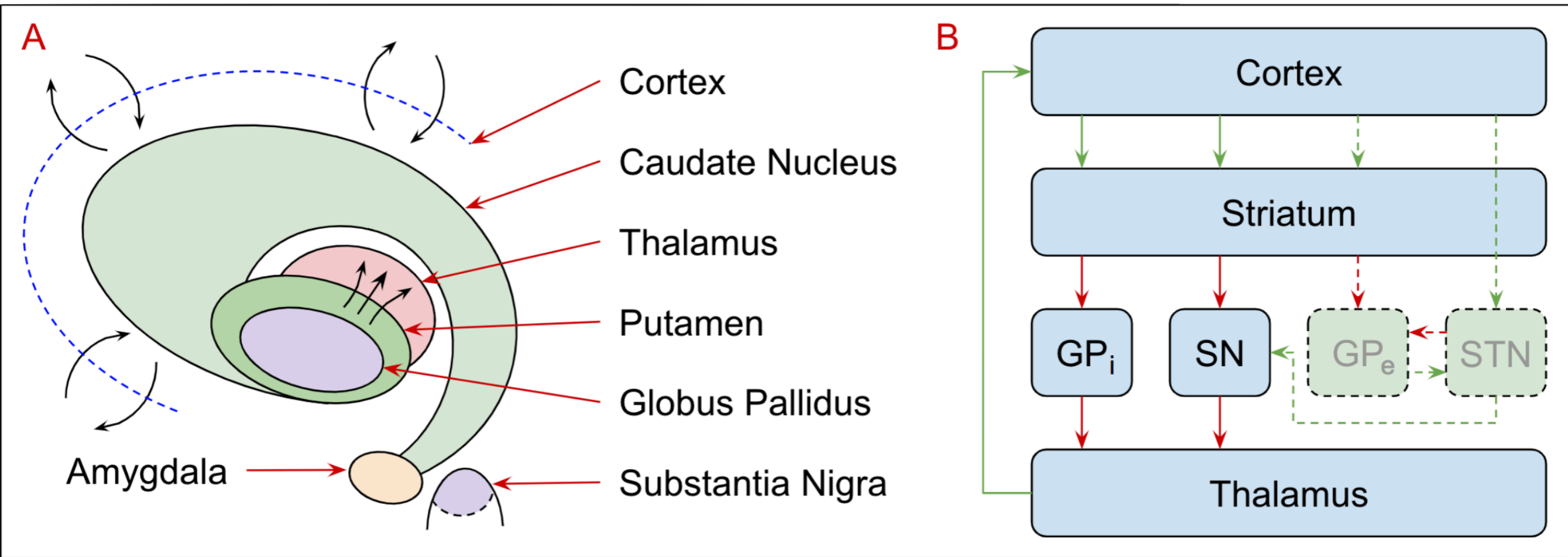

Here, we propose that the hippocampus also plays a critical role by forming and reconstructing relational memory representations that underlie flexible cognition and social behavior. There is mounting evidence that damage to the hippocampus can produce inflexible and maladaptive behavior when such behavior places high demands on the generation, recombination, and flexible use of information.

This is seen in abilities as diverse as memory, navigation, exploration, imagination, creativity, decision-making, character judgments, establishing and maintaining social bonds, empathy, social discourse, and language use. Thus, the hippocampus, together with its extensive interconnections with other neural systems, supports the flexible use of information in general.

– The role of the hippocampus in flexible cognition and social behavior. Rachael D. Rubin, Patrick D. Watson, Melissa C. Duff and Neal J. Cohen. *Frontiers in Human Neuroscience*. 2014

The hippocampus sits on “top” of the cortical hierarchy and can encode information from all over the brain, binding it together into an episodic memory. [. . .] The hippocampus seems to be particularly good at rapidly learning new information, in a way that doesn’t interfere too much with previously learned information. When you need to remember the name associated with a person you recently met, you’re relying on this rapid learning ability of the hippocampus.

All people with a functioning hippocampus have this remarkable “tape recorder” constantly encoding everything that happens during our waking lives – we don’t have to exert particular effort to recall what happened 20 minutes or a few hours ago – it is just automatically there. Most people end up forgetting the vast majority of the daily flux of our lives, retaining only the particularly salient or meaningful events.

The hippocampus does introduce one critical innovation beyond what is present in the basal ganglia and cerebellum: it has attractor dynamics. Specifically the recurrent connections between CA3 neurons are important for retrieving previously-encoded memories, via pattern completion. The price for this innovation is that the balance between excitation and inhibition must be precisely maintained, to prevent epileptic activity dynamics.

– *Computational Cognitive Neuroscience*. Randall C. O’Reilly, Yuko Munakata, Michael J. Frank, Thomas E. Hazy. 2020.

GLOBAL WORKSPACE

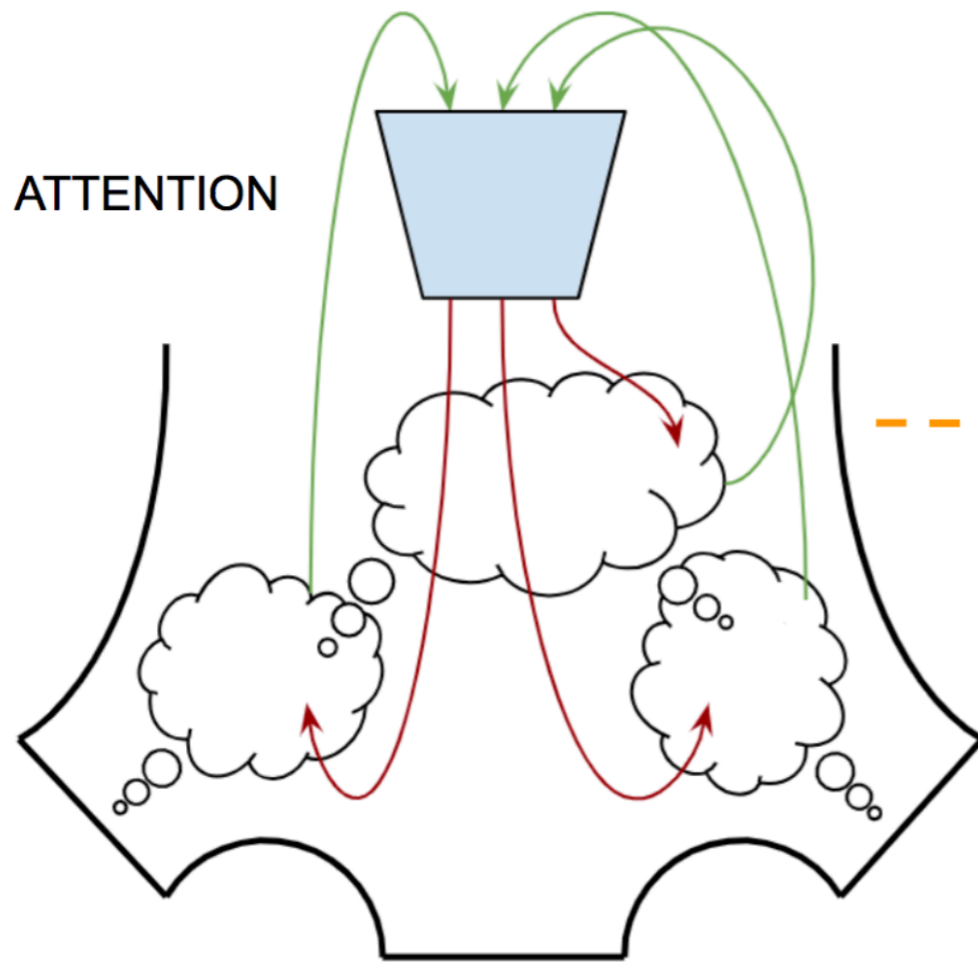

DIFFERENTIABLE NEURAL COMPUTER

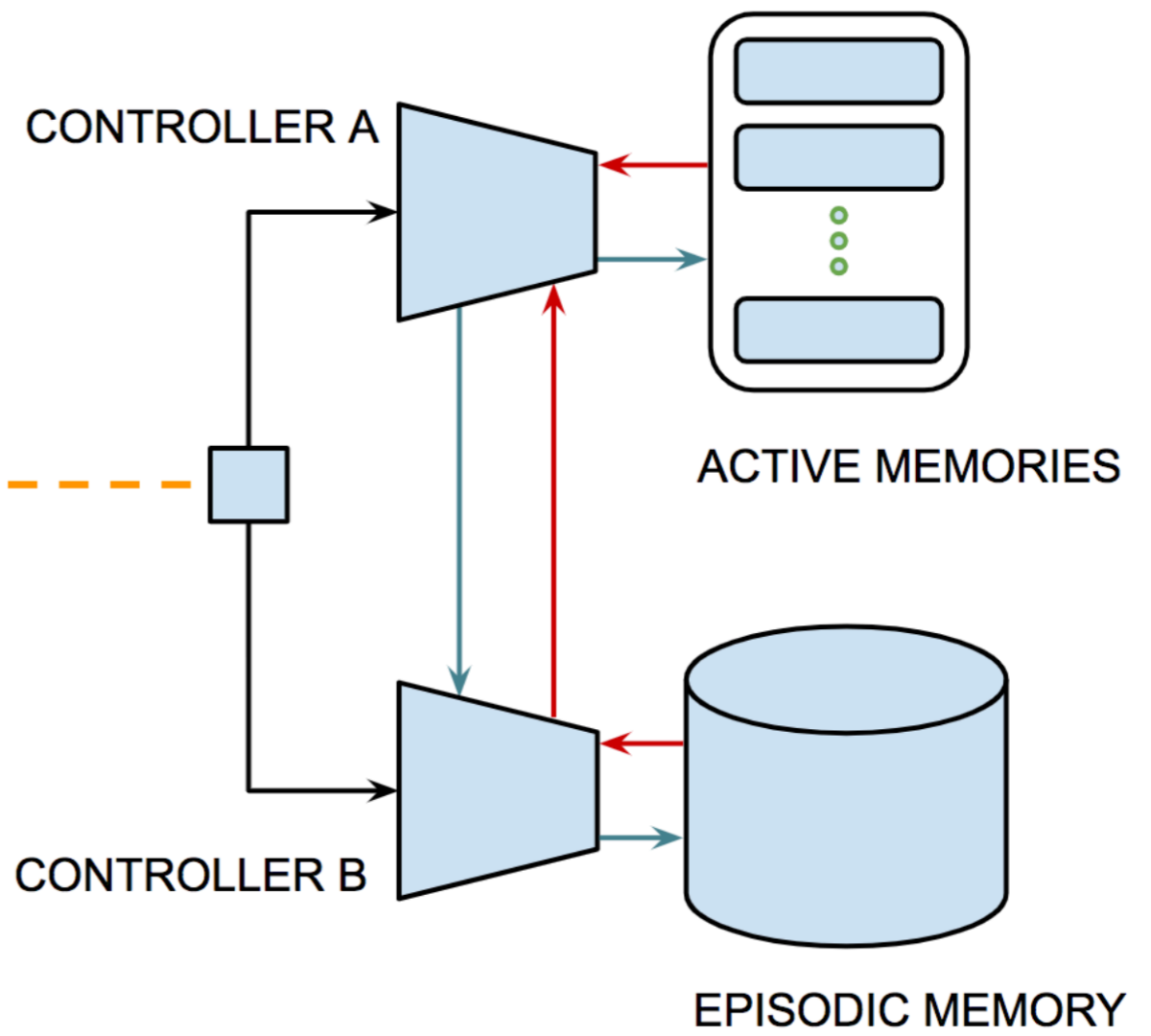

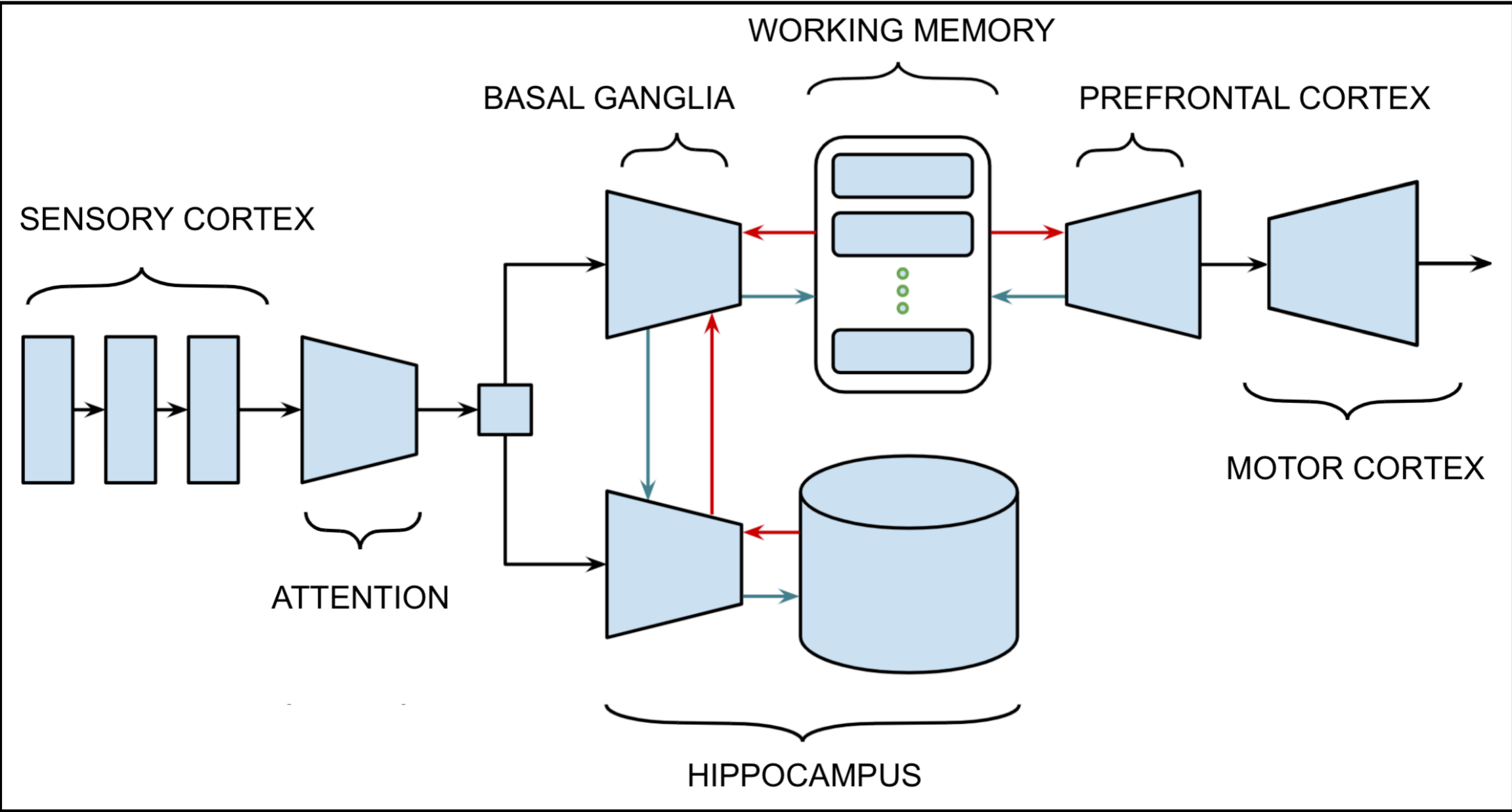

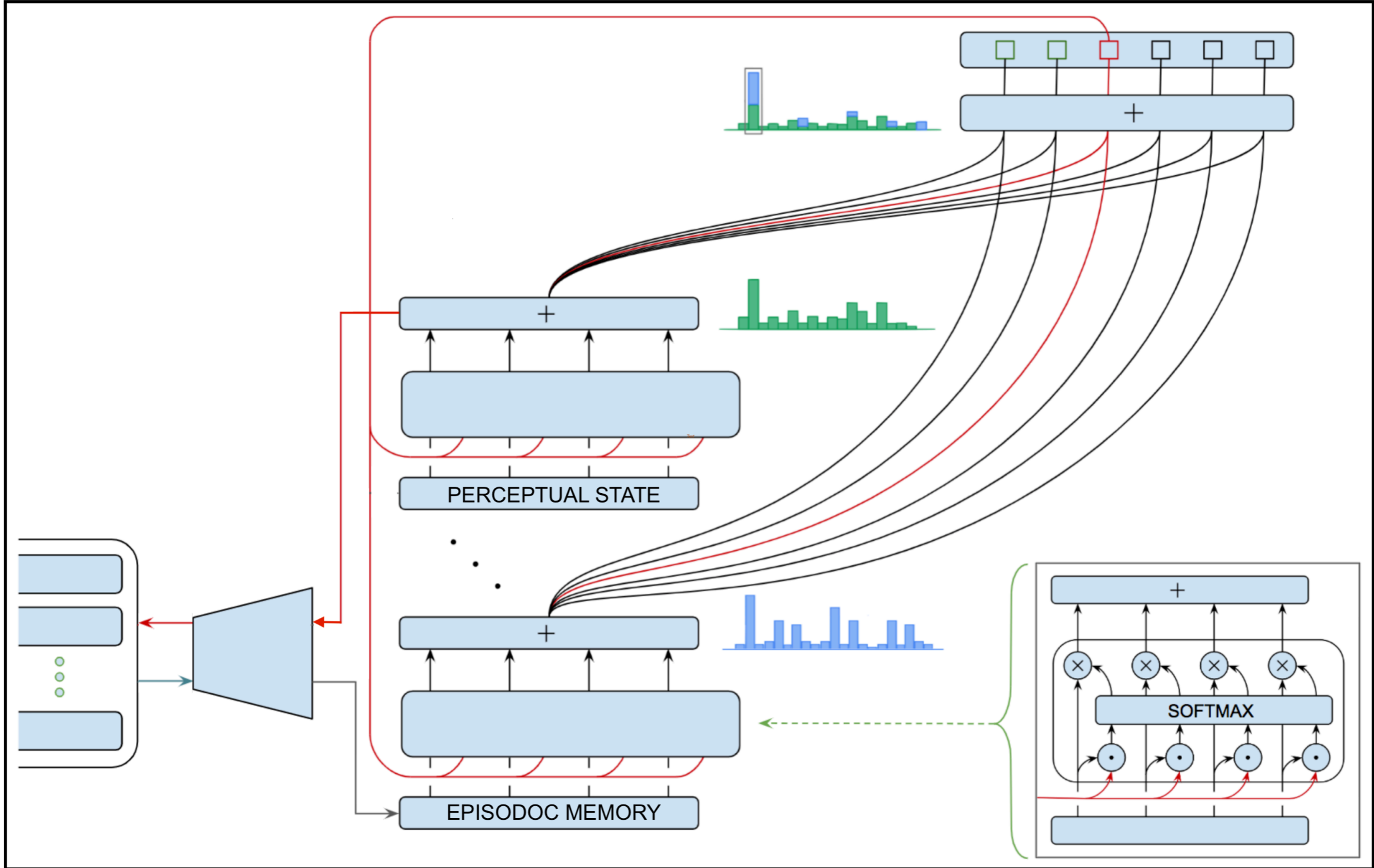

MEMORY MAPPED PERCEPTUAL STATE VECTOR

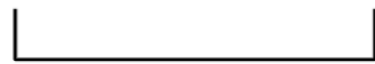

COMMAND

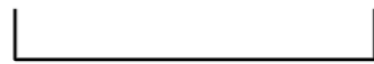

ARGUMENT

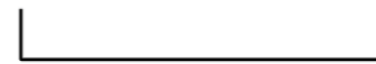

EXPRESSION

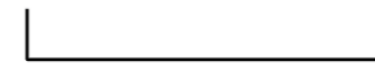

INPUT/OUTPUT

SHORT-TERM AND LONG-TERM MEMORY FORMAT

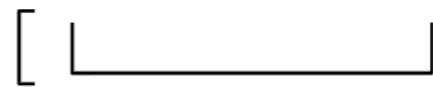

ARGUMENT_{*t*}

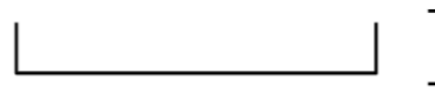

COMMAND_{*t*}

ooo

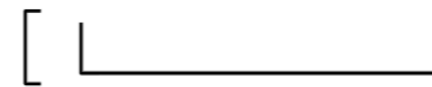

ARGUMENT_{*t + n*}

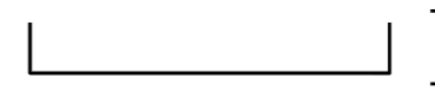

COMMAND_{*t + n*}

