

Iterative Methods

for Sparse

Linear Systems

Yousef Saad

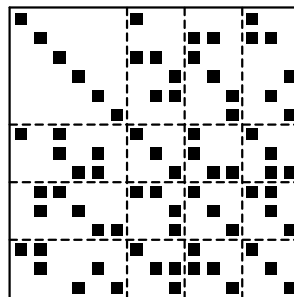
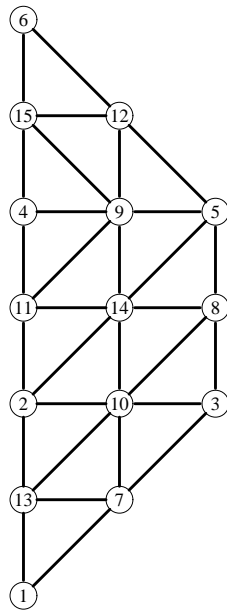

Copyright ©2000 by Yousef Saad.

SECOND EDITION WITH CORRECTIONS. JANUARY 3RD, 2000.

CONTENTS

PREFACE	xiii
Acknowledgments	xiv
Suggestions for Teaching	xv
1 BACKGROUND IN LINEAR ALGEBRA	1
1.1 Matrices	1
1.2 Square Matrices and Eigenvalues	3
1.3 Types of Matrices	4
1.4 Vector Inner Products and Norms	6
1.5 Matrix Norms	8
1.6 Subspaces, Range, and Kernel	9
1.7 Orthogonal Vectors and Subspaces	10
1.8 Canonical Forms of Matrices	15
1.8.1 Reduction to the Diagonal Form	15
1.8.2 The Jordan Canonical Form	16
1.8.3 The Schur Canonical Form	17
1.8.4 Application to Powers of Matrices	19
1.9 Normal and Hermitian Matrices	21
1.9.1 Normal Matrices	21
1.9.2 Hermitian Matrices	24
1.10 Nonnegative Matrices, M-Matrices	26
1.11 Positive-Definite Matrices	30
1.12 Projection Operators	33
1.12.1 Range and Null Space of a Projector	33
1.12.2 Matrix Representations	35
1.12.3 Orthogonal and Oblique Projectors	35
1.12.4 Properties of Orthogonal Projectors	37
1.13 Basic Concepts in Linear Systems	38
1.13.1 Existence of a Solution	38
1.13.2 Perturbation Analysis	39
Exercises and Notes	41
2 DISCRETIZATION OF PDES	44
2.1 Partial Differential Equations	44
2.1.1 Elliptic Operators	45
2.1.2 The Convection Diffusion Equation	47

2.2	Finite Difference Methods	47
2.2.1	Basic Approximations	48
2.2.2	Difference Schemes for the Laplacean Operator	49
2.2.3	Finite Differences for 1-D Problems	51
2.2.4	Upwind Schemes	51
2.2.5	Finite Differences for 2-D Problems	54
2.3	The Finite Element Method	55
2.4	Mesh Generation and Refinement	61
2.5	Finite Volume Method	63
	Exercises and Notes	66
3	<i>SPARSE MATRICES</i>	68
3.1	Introduction	68
3.2	Graph Representations	70
3.2.1	Graphs and Adjacency Graphs	70
3.2.2	Graphs of PDE Matrices	72
3.3	Permutations and Reorderings	72
3.3.1	Basic Concepts	72
3.3.2	Relations with the Adjacency Graph	75
3.3.3	Common Reorderings	75
3.3.4	Irreducibility	83
3.4	Storage Schemes	84
3.5	Basic Sparse Matrix Operations	87
3.6	Sparse Direct Solution Methods	88
3.7	Test Problems	88
	Exercises and Notes	91
4	<i>BASIC ITERATIVE METHODS</i>	95
4.1	Jacobi, Gauss-Seidel, and SOR	95
4.1.1	Block Relaxation Schemes	98
4.1.2	Iteration Matrices and Preconditioning	102
4.2	Convergence	104
4.2.1	General Convergence Result	104
4.2.2	Regular Splittings	107
4.2.3	Diagonally Dominant Matrices	108
4.2.4	Symmetric Positive Definite Matrices	112
4.2.5	Property A and Consistent Orderings	112
4.3	Alternating Direction Methods	116
	Exercises and Notes	119
5	<i>PROJECTION METHODS</i>	122
5.1	Basic Definitions and Algorithms	122
5.1.1	General Projection Methods	123
5.1.2	Matrix Representation	124
5.2	General Theory	126
5.2.1	Two Optimality Results	126

5.2.2	Interpretation in Terms of Projectors	127
5.2.3	General Error Bound	129
5.3	One-Dimensional Projection Processes	131
5.3.1	Steepest Descent	132
5.3.2	Minimal Residual (MR) Iteration	134
5.3.3	Residual Norm Steepest Descent	136
5.4	Additive and Multiplicative Processes	136
	Exercises and Notes	139
6	<i>KRYLOV SUBSPACE METHODS – PART I</i>	144
6.1	Introduction	144
6.2	Krylov Subspaces	145
6.3	Arnoldi’s Method	147
6.3.1	The Basic Algorithm	147
6.3.2	Practical Implementations	149
6.4	Arnoldi’s Method for Linear Systems (FOM)	152
6.4.1	Variation 1: Restarted FOM	154
6.4.2	Variation 2: IOM and DIOM	155
6.5	GMRES	158
6.5.1	The Basic GMRES Algorithm	158
6.5.2	The Householder Version	159
6.5.3	Practical Implementation Issues	161
6.5.4	Breakdown of GMRES	165
6.5.5	Relations between FOM and GMRES	165
6.5.6	Variation 1: Restarting	168
6.5.7	Variation 2: Truncated GMRES Versions	169
6.6	The Symmetric Lanczos Algorithm	174
6.6.1	The Algorithm	174
6.6.2	Relation with Orthogonal Polynomials	175
6.7	The Conjugate Gradient Algorithm	176
6.7.1	Derivation and Theory	176
6.7.2	Alternative Formulations	180
6.7.3	Eigenvalue Estimates from the CG Coefficients	181
6.8	The Conjugate Residual Method	183
6.9	GCR, ORTHOMIN, and ORTHODIR	183
6.10	The Faber-Manteuffel Theorem	186
6.11	Convergence Analysis	188
6.11.1	Real Chebyshev Polynomials	188
6.11.2	Complex Chebyshev Polynomials	189
6.11.3	Convergence of the CG Algorithm	193
6.11.4	Convergence of GMRES	194
6.12	Block Krylov Methods	197
	Exercises and Notes	202
7	<i>KRYLOV SUBSPACE METHODS – PART II</i>	205
7.1	Lanczos Biorthogonalization	205

7.1.1	The Algorithm	205
7.1.2	Practical Implementations	208
7.2	The Lanczos Algorithm for Linear Systems	210
7.3	The BCG and QMR Algorithms	210
7.3.1	The Biconjugate Gradient Algorithm	211
7.3.2	Quasi-Minimal Residual Algorithm	212
7.4	Transpose-Free Variants	214
7.4.1	Conjugate Gradient Squared	215
7.4.2	BICGSTAB	217
7.4.3	Transpose-Free QMR (TFQMR)	221
	Exercises and Notes	227
8	METHODS RELATED TO THE NORMAL EQUATIONS	230
8.1	The Normal Equations	230
8.2	Row Projection Methods	232
8.2.1	Gauss-Seidel on the Normal Equations	232
8.2.2	Cimmino's Method	234
8.3	Conjugate Gradient and Normal Equations	237
8.3.1	CGNR	237
8.3.2	CGNE	238
8.4	Saddle-Point Problems	240
	Exercises and Notes	243
9	PRECONDITIONED ITERATIONS	245
9.1	Introduction	245
9.2	Preconditioned Conjugate Gradient	246
9.2.1	Preserving Symmetry	246
9.2.2	Efficient Implementations	249
9.3	Preconditioned GMRES	251
9.3.1	Left-Preconditioned GMRES	251
9.3.2	Right-Preconditioned GMRES	253
9.3.3	Split Preconditioning	254
9.3.4	Comparison of Right and Left Preconditioning	255
9.4	Flexible Variants	256
9.4.1	Flexible GMRES	256
9.4.2	DQGMRES	259
9.5	Preconditioned CG for the Normal Equations	260
9.6	The CGW Algorithm	261
	Exercises and Notes	263
10	PRECONDITIONING TECHNIQUES	265
10.1	Introduction	265
10.2	Jacobi, SOR, and SSOR Preconditioners	266
10.3	ILU Factorization Preconditioners	269
10.3.1	Incomplete LU Factorizations	270
10.3.2	Zero Fill-in ILU (ILU(0))	275

10.3.3	Level of Fill and $ILU(p)$	278
10.3.4	Matrices with Regular Structure	281
10.3.5	Modified ILU (MILU)	286
10.4	Threshold Strategies and ILUT	287
10.4.1	The ILUT Approach	288
10.4.2	Analysis	289
10.4.3	Implementation Details	292
10.4.4	The ILUTP Approach	294
10.4.5	The ILUS Approach	296
10.5	Approximate Inverse Preconditioners	298
10.5.1	Approximating the Inverse of a Sparse Matrix	299
10.5.2	Global Iteration	299
10.5.3	Column-Oriented Algorithms	301
10.5.4	Theoretical Considerations	303
10.5.5	Convergence of Self Preconditioned MR	305
10.5.6	Factored Approximate Inverses	307
10.5.7	Improving a Preconditioner	310
10.6	Block Preconditioners	310
10.6.1	Block-Tridiagonal Matrices	311
10.6.2	General Matrices	312
10.7	Preconditioners for the Normal Equations	313
10.7.1	Jacobi, SOR, and Variants	313
10.7.2	IC(0) for the Normal Equations	314
10.7.3	Incomplete Gram-Schmidt and ILQ	316
	Exercises and Notes	319

11 PARALLEL IMPLEMENTATIONS **324**

11.1	Introduction	324
11.2	Forms of Parallelism	325
11.2.1	Multiple Functional Units	325
11.2.2	Pipelining	326
11.2.3	Vector Processors	326
11.2.4	Multiprocessing and Distributed Computing	326
11.3	Types of Parallel Architectures	327
11.3.1	Shared Memory Computers	327
11.3.2	Distributed Memory Architectures	329
11.4	Types of Operations	331
11.4.1	Preconditioned CG	332
11.4.2	GMRES	332
11.4.3	Vector Operations	333
11.4.4	Reverse Communication	334
11.5	Matrix-by-Vector Products	335
11.5.1	The Case of Dense Matrices	335
11.5.2	The CSR and CSC Formats	336
11.5.3	Matvecs in the Diagonal Format	339
11.5.4	The Ellpack-Itpack Format	340

11.5.5	The Jagged Diagonal Format	341
11.5.6	The Case of Distributed Sparse Matrices	342
11.6	Standard Preconditioning Operations	345
11.6.1	Parallelism in Forward Sweeps	346
11.6.2	Level Scheduling: the Case of 5-Point Matrices	346
11.6.3	Level Scheduling for Irregular Graphs	347
	Exercises and Notes	350

12 PARALLEL PRECONDITIONERS 353

12.1	Introduction	353
12.2	Block-Jacobi Preconditioners	354
12.3	Polynomial Preconditioners	356
12.3.1	Neumann Polynomials	356
12.3.2	Chebyshev Polynomials	357
12.3.3	Least-Squares Polynomials	360
12.3.4	The Nonsymmetric Case	363
12.4	Multicoloring	365
12.4.1	Red-Black Ordering	366
12.4.2	Solution of Red-Black Systems	367
12.4.3	Multicoloring for General Sparse Matrices	368
12.5	Multi-Elimination ILU	369
12.5.1	Multi-Elimination	370
12.5.2	ILUM	371
12.6	Distributed ILU and SSOR	374
12.6.1	Distributed Sparse Matrices	374
12.7	Other Techniques	376
12.7.1	Approximate Inverses	377
12.7.2	Element-by-Element Techniques	377
12.7.3	Parallel Row Projection Preconditioners	379
	Exercises and Notes	380

13 DOMAIN DECOMPOSITION METHODS 383

13.1	Introduction	383
13.1.1	Notation	384
13.1.2	Types of Partitionings	385
13.1.3	Types of Techniques	386
13.2	Direct Solution and the Schur Complement	388
13.2.1	Block Gaussian Elimination	388
13.2.2	Properties of the Schur Complement	389
13.2.3	Schur Complement for Vertex-Based Partitionings	390
13.2.4	Schur Complement for Finite-Element Partitionings	393
13.3	Schwarz Alternating Procedures	395
13.3.1	Multiplicative Schwarz Procedure	395
13.3.2	Multiplicative Schwarz Preconditioning	400
13.3.3	Additive Schwarz Procedure	402
13.3.4	Convergence	404

13.4 Schur Complement Approaches	408
13.4.1 Induced Preconditioners	408
13.4.2 Probing	410
13.4.3 Preconditioning Vertex-Based Schur Complements	411
13.5 Full Matrix Methods	412
13.6 Graph Partitioning	414
13.6.1 Basic Definitions	414
13.6.2 Geometric Approach	415
13.6.3 Spectral Techniques	417
13.6.4 Graph Theory Techniques	418
Exercises and Notes	422
<i>REFERENCES</i>	425
<i>INDEX</i>	439



PREFACE

Iterative methods for solving general, large sparse linear systems have been gaining popularity in many areas of scientific computing. Until recently, direct solution methods were often preferred to iterative methods in real applications because of their robustness and predictable behavior. However, a number of efficient iterative solvers were discovered and the increased need for solving very large linear systems triggered a noticeable and rapid shift toward iterative techniques in many applications.

This trend can be traced back to the 1960s and 1970s when two important developments revolutionized solution methods for large linear systems. First was the realization that one can take advantage of “sparsity” to design special direct methods that can be quite economical. Initiated by electrical engineers, these “direct sparse solution methods” led to the development of reliable and efficient general-purpose direct solution software codes over the next three decades. Second was the emergence of preconditioned conjugate gradient-like methods for solving linear systems. It was found that the combination of preconditioning and Krylov subspace iterations could provide efficient and simple “general-purpose” procedures that could compete with direct solvers. Preconditioning involves exploiting ideas from sparse direct solvers. Gradually, iterative methods started to approach the quality of direct solvers. In earlier times, iterative methods were often special-purpose in nature. They were developed with certain applications in mind, and their efficiency relied on many problem-dependent parameters.

Now, three-dimensional models are commonplace and iterative methods are almost mandatory. The memory and the computational requirements for solving three-dimensional Partial Differential Equations, or two-dimensional ones involving many degrees of freedom per point, may seriously challenge the most efficient direct solvers available today. Also, iterative methods are gaining ground because they are easier to implement efficiently on high-performance computers than direct methods.

My intention in writing this volume is to provide up-to-date coverage of iterative methods for solving large sparse linear systems. I focused the book on practical methods that work for general sparse matrices rather than for any specific class of problems. It is indeed becoming important to embrace applications not necessarily governed by Partial Differential Equations, as these applications are on the rise. Apart from two recent volumes by Axelsson [15] and Hackbusch [116], few books on iterative methods have appeared since the excellent ones by Varga [213], and later Young [232]. Since then, researchers and practitioners have achieved remarkable progress in the development and use of effective iterative methods. Unfortunately, fewer elegant results have been discovered since the 1950s and 1960s. The field has moved in other directions. Methods have gained not only in efficiency but also in robustness and in generality. The traditional techniques which required

rather complicated procedures to determine optimal acceleration parameters have yielded to the parameter-free conjugate gradient class of methods.

The primary aim of this book is to describe some of the best techniques available today, from both preconditioners and accelerators. One of the aims of the book is to provide a good mix of theory and practice. It also addresses some of the current research issues such as parallel implementations and robust preconditioners. The emphasis is on Krylov subspace methods, currently the most practical and common group of techniques used in applications. Although there is a tutorial chapter that covers the discretization of Partial Differential Equations, the book is not biased toward any specific application area. Instead, the matrices are assumed to be general sparse, possibly irregularly structured.

The book has been structured in four distinct parts. The first part, Chapters 1 to 4, presents the basic tools. The second part, Chapters 5 to 8, presents projection methods and Krylov subspace techniques. The third part, Chapters 9 and 10, discusses preconditioning. The fourth part, Chapters 11 to 13, discusses parallel implementations and parallel algorithms.

ACKNOWLEDGMENTS

I am grateful to a number of colleagues who proofread or reviewed different versions of the manuscript. Among them are Randy Bramley (University of Indiana at Bloomington), Xiao-Chuan Cai (University of Colorado at Boulder), Tony Chan (University of California at Los Angeles), Jane Cullum (IBM, Yorktown Heights), Alan Edelman (Massachusetts Institute of Technology), Paul Fischer (Brown University), David Keyes (Old Dominion University), Beresford Parlett (University of California at Berkeley) and Shang-Hua Teng (University of Minnesota). Their numerous comments, corrections, and encouragements were a highly appreciated contribution. In particular, they helped improve the presentation considerably and prompted the addition of a number of topics missing from earlier versions.

This book evolved from several successive improvements of a set of lecture notes for the course “Iterative Methods for Linear Systems” which I taught at the University of Minnesota in the last few years. I apologize to those students who used the earlier error-laden and incomplete manuscripts. Their input and criticism contributed significantly to improving the manuscript. I also wish to thank those students at MIT (with Alan Edelman) and UCLA (with Tony Chan) who used this book in manuscript form and provided helpful feedback. My colleagues at the university of Minnesota, staff and faculty members, have helped in different ways. I wish to thank in particular Ahmed Sameh for his encouragements and for fostering a productive environment in the department. Finally, I am grateful to the National Science Foundation for their continued financial support of my research, part of which is represented in this work.

Yousef Saad

SUGGESTIONS FOR TEACHING

This book can be used as a text to teach a graduate-level course on iterative methods for linear systems. Selecting topics to teach depends on whether the course is taught in a mathematics department or a computer science (or engineering) department, and whether the course is over a semester or a quarter. Here are a few comments on the relevance of the topics in each chapter.

For a graduate course in a mathematics department, much of the material in Chapter 1 should be known already. For non-mathematics majors most of the chapter must be covered or reviewed to acquire a good background for later chapters. The important topics for the rest of the book are in Sections: 1.8.1, 1.8.3, 1.8.4, 1.9, 1.11. Section 1.12 is best treated at the beginning of Chapter 5. Chapter 2 is essentially independent from the rest and could be skipped altogether in a quarter course. One lecture on finite differences and the resulting matrices would be enough for a non-math course. Chapter 3 should make the student familiar with some implementation issues associated with iterative solution procedures for general sparse matrices. In a computer science or engineering department, this can be very relevant. For mathematicians, a mention of the graph theory aspects of sparse matrices and a few storage schemes may be sufficient. Most students at this level should be familiar with a few of the elementary relaxation techniques covered in Chapter 4. The convergence theory can be skipped for non-math majors. These methods are now often used as preconditioners and this may be the only motive for covering them.

Chapter 5 introduces key concepts and presents projection techniques in general terms. Non-mathematicians may wish to skip Section 5.2.3. Otherwise, it is recommended to start the theory section by going back to Section 1.12 on general definitions on projectors. Chapters 6 and 7 represent the heart of the matter. It is recommended to describe the first algorithms carefully and put emphasis on the fact that they generalize the one-dimensional methods covered in Chapter 5. It is also important to stress the optimality properties of those methods in Chapter 6 and the fact that these follow immediately from the properties of projectors seen in Section 1.12. When covering the algorithms in Chapter 7, it is crucial to point out the main differences between them and those seen in Chapter 6. The variants such as CGS, BICGSTAB, and TFQMR can be covered in a short time, omitting details of the algebraic derivations or covering only one of the three. The class of methods based on the normal equation approach, i.e., Chapter 8, can be skipped in a math-oriented course, especially in the case of a quarter system. For a semester course, selected topics may be Sections 8.1, 8.2, and 8.4.

Currently, preconditioning is known to be the critical ingredient in the success of iterative methods in solving real-life problems. Therefore, at least some parts of Chapter 9 and Chapter 10 should be covered. Section 9.2 and (very briefly) 9.3 are recommended. From Chapter 10, discuss the basic ideas in Sections 10.1 through 10.3. The rest could be skipped in a quarter course.

Chapter 11 may be useful to present to computer science majors, but may be skimmed or skipped in a mathematics or an engineering course. Parts of Chapter 12 could be taught primarily to make the students aware of the importance of “alternative” preconditioners. Suggested selections are: 12.2, 12.4, and 12.7.2 (for engineers). Chapter 13 presents an im-

portant research area and is primarily geared to mathematics majors. Computer scientists or engineers may prefer to cover this material in less detail.

To make these suggestions more specific, the following two tables are offered as sample course outlines. Numbers refer to sections in the text. A semester course represents approximately 30 lectures of 75 minutes each whereas a quarter course is approximately 20 lectures of 75 minutes each. Different topics are selected for a mathematics course and a non-mathematics course.

Semester course		
Weeks	Mathematics	Computer Science / Eng.
1 – 3	1.9 – 1.13 2.1 – 2.5 3.1 – 3.3, 3.7	1.1 – 1.6 (Read) 1.7 – 1.13, 2.1 – 2.2 3.1 – 3.7
4 – 6	4.1 – 4.3 5.1 – 5.4 6.1 – 6.3	4.1 – 4.2 5.1 – 5.2.1 6.1 – 6.3
7 – 9	6.4 – 6.7 (Except 6.5.2) 6.9 – 6.11 7.1 – 7.3	6.4 – 6.5 (Except 6.5.5) 6.7.1, 6.8–6.9, 6.11.3. 7.1 – 7.3
10 – 12	7.4.1; 7.4.2 – 7.4.3 (Read) 8.1, 8.2, 8.4; 9.1 – 9.3 10.1 – 10.3	7.4.1; 7.4.2 – 7.4.3 (Read) 8.1 – 8.3; 9.1 – 9.3 10.1 – 10.4
13 – 15	10.5.1 – 10.5.6 10.6; 12.2 – 12.4 13.1 – 13.6	10.5.1 – 10.5.4 11.1 – 11.4 (Read); 11.5 – 11.6 12.1 – 12.2; 12.4 – 12.7

Quarter course		
Weeks	Mathematics	Computer Science / Eng.
1 – 2	1.9 – 1.13, 3.1 – 3.2 4.1 – 4.3	1.1 – 1.6 (Read); 3.1 – 3.7 4.1
3 – 4	5.1 – 5.4 6.1 – 6.4	5.1 – 5.2.1 6.1 – 6.3
5 – 6	6.4 – 6.7 (Except 6.5.2) 6.11, 7.1 – 7.3	6.4 – 6.5 (Except 6.5.5) 6.7.1, 6.11.3, 7.1 – 7.3
7 – 8	7.4.1; 7.4.2 – 7.4.3 (Read) 9.1 – 9.3; 10.1 – 10.3	7.4.1; 7.4.2 – 7.4.3 (Read) 9.1 – 9.3; 10.1 – 10.3
9 – 10	10.6; 12.2 – 12.4 13.1 – 13.4	11.1 – 11.4 (Read); 11.5 – 11.6 12.1 – 12.2; 12.4 – 12.7

BACKGROUND IN LINEAR ALGEBRA

This chapter gives an overview of the relevant concepts in linear algebra which are useful in later chapters. It begins with a review of basic matrix theory and introduces the elementary notation used throughout the book. The convergence analysis of iterative methods requires a good level of knowledge in mathematical analysis and in linear algebra. Traditionally, many of the concepts presented specifically for these analyses have been geared toward matrices arising from the discretization of Partial Differential Equations and basic relaxation-type methods. These concepts are now becoming less important because of the trend toward projection-type methods which have more robust convergence properties and require different analysis tools. The material covered in this chapter will be helpful in establishing some theory for the algorithms and defining the notation used throughout the book.

MATRICES

1.1

For the sake of generality, all vector spaces considered in this chapter are complex, unless otherwise stated. A complex $n \times m$ matrix A is an $n \times m$ array of complex numbers

$$a_{ij}, \quad i = 1, \dots, n, \quad j = 1, \dots, m.$$

The set of all $n \times m$ matrices is a complex vector space denoted by $\mathbb{C}^{n \times m}$. The main operations with matrices are the following:

- Addition: $C = A + B$, where A, B , and C are matrices of size $n \times m$ and

$$c_{ij} = a_{ij} + b_{ij}, \quad i = 1, 2, \dots, n, \quad j = 1, 2, \dots, m.$$

- Multiplication by a scalar: $C = \alpha A$, where

$$c_{ij} = \alpha a_{ij}, \quad i = 1, 2, \dots, n, \quad j = 1, 2, \dots, m.$$

- Multiplication by another matrix:

$$C = AB,$$

where $A \in \mathbb{C}^{n \times m}$, $B \in \mathbb{C}^{m \times p}$, $C \in \mathbb{C}^{n \times p}$, and

$$c_{ij} = \sum_{k=1}^m a_{ik} b_{kj}.$$

Sometimes, a notation with column vectors and row vectors is used. The column vector a_{*j} is the vector consisting of the j -th column of A ,

$$a_{*j} = \begin{pmatrix} a_{1j} \\ a_{2j} \\ \vdots \\ a_{nj} \end{pmatrix}.$$

Similarly, the notation a_{i*} will denote the i -th row of the matrix A

$$a_{i*} = (a_{i1}, a_{i2}, \dots, a_{im}).$$

For example, the following could be written

$$A = (a_{*1}, a_{*2}, \dots, a_{*m}),$$

or

$$A = \begin{pmatrix} a_{1*} \\ a_{2*} \\ \vdots \\ a_{n*} \end{pmatrix}.$$

The *transpose* of a matrix A in $\mathbb{C}^{n \times m}$ is a matrix C in $\mathbb{C}^{m \times n}$ whose elements are defined by $c_{ij} = a_{ji}$, $i = 1, \dots, m$, $j = 1, \dots, n$. It is denoted by A^T . It is often more relevant to use the *transpose conjugate* matrix denoted by A^H and defined by

$$A^H = \bar{A}^T = \overline{A^T},$$

in which the bar denotes the (element-wise) complex conjugation.

Matrices are strongly related to linear mappings between vector spaces of finite dimension. This is because they represent these mappings with respect to two given bases: one for the initial vector space and the other for the image vector space, or *range* of A .

 SQUARE MATRICES AND EIGENVALUES

 1.2

A matrix is *square* if it has the same number of columns and rows, i.e., if $m = n$. An important square matrix is the identity matrix

$$I = \{\delta_{ij}\}_{i,j=1,\dots,n},$$

where δ_{ij} is the Kronecker symbol. The identity matrix satisfies the equality $AI = IA = A$ for every matrix A of size n . The inverse of a matrix, when it exists, is a matrix C such that

$$CA = AC = I.$$

The inverse of A is denoted by A^{-1} .

The *determinant* of a matrix may be defined in several ways. For simplicity, the following recursive definition is used here. The determinant of a 1×1 matrix (a) is defined as the scalar a . Then the determinant of an $n \times n$ matrix is given by

$$\det(A) = \sum_{j=1}^n (-1)^{j+1} a_{1j} \det(A_{1j}),$$

where A_{1j} is an $(n-1) \times (n-1)$ matrix obtained by deleting the first row and the j -th column of A . A matrix is said to be *singular* when $\det(A) = 0$ and *nonsingular* otherwise. We have the following simple properties:

- $\det(AB) = \det(BA)$.
- $\det(A^T) = \det(A)$.
- $\det(\alpha A) = \alpha^n \det(A)$.
- $\det(\bar{A}) = \overline{\det(A)}$.
- $\det(I) = 1$.

From the above definition of determinants it can be shown by induction that the function that maps a given complex value λ to the value $p_A(\lambda) = \det(A - \lambda I)$ is a polynomial of degree n ; see Exercise 8. This is known as the *characteristic polynomial* of the matrix A .

DEFINITION 1.1 A complex scalar λ is called an *eigenvalue* of the square matrix A if a nonzero vector u of \mathbb{C}^n exists such that $Au = \lambda u$. The vector u is called an *eigenvector* of A associated with λ . The set of all the eigenvalues of A is called the *spectrum* of A and is denoted by $\sigma(A)$.

A scalar λ is an eigenvalue of A if and only if $\det(A - \lambda I) \equiv p_A(\lambda) = 0$. That is true *if and only if* (iff thereafter) λ is a root of the characteristic polynomial. In particular, there are at most n distinct eigenvalues.

It is clear that a matrix is singular if and only if it admits zero as an eigenvalue. A well known result in linear algebra is stated in the following proposition.

PROPOSITION 1.1 A matrix A is nonsingular if and only if it admits an inverse.

Thus, the determinant of a matrix determines whether or not the matrix admits an inverse.

The maximum modulus of the eigenvalues is called *spectral radius* and is denoted by $\rho(A)$

$$\rho(A) = \max_{\lambda \in \sigma(A)} |\lambda|.$$

The *trace* of a matrix is equal to the sum of all its diagonal elements

$$\text{tr}(A) = \sum_{i=1}^n a_{ii}.$$

It can be easily shown that the trace of A is also equal to the sum of the eigenvalues of A counted with their multiplicities as roots of the characteristic polynomial.

PROPOSITION 1.2 *If λ is an eigenvalue of A , then $\bar{\lambda}$ is an eigenvalue of A^H . An eigenvector v of A^H associated with the eigenvalue $\bar{\lambda}$ is called a left eigenvector of A .*

When a distinction is necessary, an eigenvector of A is often called a right eigenvector. Therefore, the eigenvalue λ as well as the right and left eigenvectors, u and v , satisfy the relations

$$Au = \lambda u, \quad v^H A = \lambda v^H,$$

or, equivalently,

$$u^H A^H = \bar{\lambda} u^H, \quad A^H v = \bar{\lambda} v.$$

TYPES OF MATRICES

1.3

The choice of a method for solving linear systems will often depend on the structure of the matrix A . One of the most important properties of matrices is symmetry, because of its impact on the eigenstructure of A . A number of other classes of matrices also have particular eigenstructures. The most important ones are listed below:

- *Symmetric matrices:* $A^T = A$.
- *Hermitian matrices:* $A^H = A$.
- *Skew-symmetric matrices:* $A^T = -A$.
- *Skew-Hermitian matrices:* $A^H = -A$.
- *Normal matrices:* $A^H A = A A^H$.
- *Nonnegative matrices:* $a_{ij} \geq 0$, $i, j = 1, \dots, n$ (similar definition for nonpositive, positive, and negative matrices).
- *Unitary matrices:* $Q^H Q = I$.

It is worth noting that a unitary matrix Q is a matrix whose inverse is its transpose conjugate Q^H , since

$$Q^H Q = I \quad \rightarrow \quad Q^{-1} = Q^H. \quad (1.1)$$

A matrix Q such that $Q^H Q$ is diagonal is often called orthogonal.

Some matrices have particular structures that are often convenient for computational purposes. The following list, though incomplete, gives an idea of these special matrices which play an important role in numerical analysis and scientific computing applications.

- *Diagonal matrices*: $a_{ij} = 0$ for $j \neq i$. Notation:

$$A = \text{diag} (a_{11}, a_{22}, \dots, a_{nn}).$$

- *Upper triangular matrices*: $a_{ij} = 0$ for $i > j$.
- *Lower triangular matrices*: $a_{ij} = 0$ for $i < j$.
- *Upper bidiagonal matrices*: $a_{ij} = 0$ for $j \neq i$ or $j \neq i + 1$.
- *Lower bidiagonal matrices*: $a_{ij} = 0$ for $j \neq i$ or $j \neq i - 1$.
- *Tridiagonal matrices*: $a_{ij} = 0$ for any pair i, j such that $|j - i| > 1$. Notation:

$$A = \text{tridiag} (a_{i,i-1}, a_{ii}, a_{i,i+1}).$$

- *Banded matrices*: $a_{ij} \neq 0$ only if $i - m_l \leq j \leq i + m_u$, where m_l and m_u are two nonnegative integers. The number $m_l + m_u + 1$ is called the bandwidth of A .
- *Upper Hessenberg matrices*: $a_{ij} = 0$ for any pair i, j such that $i > j + 1$. Lower Hessenberg matrices can be defined similarly.
- *Outer product matrices*: $A = uv^H$, where both u and v are vectors.
- *Permutation matrices*: the columns of A are a permutation of the columns of the identity matrix.
- *Block diagonal matrices*: generalizes the diagonal matrix by replacing each diagonal entry by a matrix. Notation:

$$A = \text{diag} (A_{11}, A_{22}, \dots, A_{nn}).$$

- *Block tridiagonal matrices*: generalizes the tridiagonal matrix by replacing each nonzero entry by a square matrix. Notation:

$$A = \text{tridiag} (A_{i,i-1}, A_{ii}, A_{i,i+1}).$$

The above properties emphasize structure, i.e., positions of the nonzero elements with respect to the zeros. Also, they assume that there are many zero elements or that the matrix is of low rank. This is in contrast with the classifications listed earlier, such as symmetry or normality.

VECTOR INNER PRODUCTS AND NORMS

1.4

An inner product on a (complex) vector space \mathbb{X} is any mapping s from $\mathbb{X} \times \mathbb{X}$ into \mathbb{C} ,

$$x \in \mathbb{X}, y \in \mathbb{X} \rightarrow s(x, y) \in \mathbb{C},$$

which satisfies the following conditions:

1. $s(x, y)$ is linear with respect to x , i.e.,

$$s(\lambda_1 x_1 + \lambda_2 x_2, y) = \lambda_1 s(x_1, y) + \lambda_2 s(x_2, y), \quad \forall x_1, x_2 \in \mathbb{X}, \forall \lambda_1, \lambda_2 \in \mathbb{C}.$$

2. $s(x, y)$ is *Hermitian*, i.e.,

$$s(y, x) = \overline{s(x, y)}, \quad \forall x, y \in \mathbb{X}.$$

3. $s(x, y)$ is *positive definite*, i.e.,

$$s(x, x) > 0, \quad \forall x \neq 0.$$

Note that (2) implies that $s(x, x)$ is real and therefore, (3) adds the constraint that $s(x, x)$ must also be positive for any nonzero x . For any x and y ,

$$s(x, 0) = s(x, 0 \cdot y) = 0 \cdot s(x, y) = 0.$$

Similarly, $s(0, y) = 0$ for any y . Hence, $s(0, y) = s(x, 0) = 0$ for any x and y . In particular the condition (3) can be rewritten as

$$s(x, x) \geq 0 \quad \text{and} \quad s(x, x) = 0 \quad \text{iff} \quad x = 0,$$

as can be readily shown. A useful relation satisfied by any inner product is the so-called Cauchy-Schwartz inequality:

$$|s(x, y)|^2 \leq s(x, x) s(y, y). \quad (1.2)$$

The proof of this inequality begins by expanding $s(x - \lambda y, x - \lambda y)$ using the properties of s ,

$$s(x - \lambda y, x - \lambda y) = s(x, x) - \bar{\lambda} s(x, y) - \lambda s(y, x) + |\lambda|^2 s(y, y).$$

If $y = 0$ then the inequality is trivially satisfied. Assume that $y \neq 0$ and take $\lambda = s(x, y)/s(y, y)$. Then $s(x - \lambda y, x - \lambda y) \geq 0$ shows the above equality

$$\begin{aligned} 0 \leq s(x - \lambda y, x - \lambda y) &= s(x, x) - 2 \frac{|s(x, y)|^2}{s(y, y)} + \frac{|s(x, y)|^2}{s(y, y)} \\ &= s(x, x) - \frac{|s(x, y)|^2}{s(y, y)}, \end{aligned}$$

which yields the result (1.2).

In the particular case of the vector space $\mathbb{X} = \mathbb{C}^n$, a “canonical” inner product is the *Euclidean inner product*. The Euclidean inner product of two vectors $x = (x_i)_{i=1, \dots, n}$ and

$y = (y_i)_{i=1, \dots, n}$ of \mathbb{C}^n is defined by

$$(x, y) = \sum_{i=1}^n x_i \bar{y}_i, \quad (1.3)$$

which is often rewritten in matrix notation as

$$(x, y) = y^H x. \quad (1.4)$$

It is easy to verify that this mapping does indeed satisfy the three conditions required for inner products, listed above. A fundamental property of the Euclidean inner product in matrix computations is the simple relation

$$(Ax, y) = (x, A^H y), \quad \forall x, y \in \mathbb{C}^n. \quad (1.5)$$

The proof of this is straightforward. The *adjoint* of A with respect to an arbitrary inner product is a matrix B such that $(Ax, y) = (x, By)$ for all pairs of vectors x and y . A matrix is *self-adjoint*, or Hermitian with respect to this inner product, if it is equal to its adjoint.

The following proposition is a consequence of the equality (1.5).

PROPOSITION 1.3 *Unitary matrices preserve the Euclidean inner product, i.e.,*

$$(Qx, Qy) = (x, y)$$

for any unitary matrix Q and any vectors x and y .

Proof. Indeed, $(Qx, Qy) = (x, Q^H Qy) = (x, y)$. ■

A vector norm on a vector space \mathbb{X} is a real-valued function $x \rightarrow \|x\|$ on \mathbb{X} , which satisfies the following three conditions:

1. $\|x\| \geq 0$, $\forall x \in \mathbb{X}$, and $\|x\| = 0$ iff $x = 0$.
2. $\|\alpha x\| = |\alpha| \|x\|$, $\forall x \in \mathbb{X}$, $\forall \alpha \in \mathbb{C}$.
3. $\|x + y\| \leq \|x\| + \|y\|$, $\forall x, y \in \mathbb{X}$.

For the particular case when $\mathbb{X} = \mathbb{C}^n$, we can associate with the inner product (1.3) the *Euclidean norm* of a complex vector defined by

$$\|x\|_2 = (x, x)^{1/2}.$$

It follows from Proposition 1.3 that a unitary matrix preserves the Euclidean norm metric, i.e.,

$$\|Qx\|_2 = \|x\|_2, \quad \forall x.$$

The linear transformation associated with a unitary matrix Q is therefore an *isometry*.

The most commonly used vector norms in numerical linear algebra are special cases of the Hölder norms

$$\|x\|_p = \left(\sum_{i=1}^n |x_i|^p \right)^{1/p}. \quad (1.6)$$

Note that the limit of $\|x\|_p$ when p tends to infinity exists and is equal to the maximum modulus of the x_i 's. This defines a norm denoted by $\|\cdot\|_\infty$. The cases $p = 1$, $p = 2$, and $p = \infty$ lead to the most important norms in practice,

$$\begin{aligned}\|x\|_1 &= |x_1| + |x_2| + \cdots + |x_n|, \\ \|x\|_2 &= [|x_1|^2 + |x_2|^2 + \cdots + |x_n|^2]^{1/2}, \\ \|x\|_\infty &= \max_{i=1, \dots, n} |x_i|.\end{aligned}$$

The Cauchy-Schwartz inequality of (1.2) becomes

$$|(x, y)| \leq \|x\|_2 \|y\|_2.$$

MATRIX NORMS

1.5

For a general matrix A in $\mathbb{C}^{n \times m}$, we define the following special set of norms

$$\|A\|_{pq} = \max_{x \in \mathbb{C}^m, x \neq 0} \frac{\|Ax\|_p}{\|x\|_q}. \quad (1.7)$$

The norm $\|\cdot\|_{pq}$ is *induced* by the two norms $\|\cdot\|_p$ and $\|\cdot\|_q$. These norms satisfy the usual properties of norms, i.e.,

$$\begin{aligned}\|A\| &\geq 0, \quad \forall A \in \mathbb{C}^{n \times m}, \quad \text{and} \quad \|A\| = 0 \quad \text{iff} \quad A = 0 \\ \|\alpha A\| &= |\alpha| \|A\|, \quad \forall A \in \mathbb{C}^{n \times m}, \quad \forall \alpha \in \mathbb{C} \\ \|A + B\| &\leq \|A\| + \|B\|, \quad \forall A, B \in \mathbb{C}^{n \times m}.\end{aligned}$$

The most important cases are again those associated with $p, q = 1, 2, \infty$. The case $q = p$ is of particular interest and the associated norm $\|\cdot\|_{pq}$ is simply denoted by $\|\cdot\|_p$ and called a “ p -norm.” A fundamental property of a p -norm is that

$$\|AB\|_p \leq \|A\|_p \|B\|_p,$$

an immediate consequence of the definition (1.7). Matrix norms that satisfy the above property are sometimes called *consistent*. A result of consistency is that for any square matrix A ,

$$\|A^k\|_p \leq \|A\|_p^k.$$

In particular the matrix A^k converges to zero if *any* of its p -norms is less than 1.

The Frobenius norm of a matrix is defined by

$$\|A\|_F = \left(\sum_{j=1}^m \sum_{i=1}^n |a_{ij}|^2 \right)^{1/2}. \quad (1.8)$$

This can be viewed as the 2-norm of the column (or row) vector in \mathbb{C}^{n^2} consisting of all the columns (respectively rows) of A listed from 1 to m (respectively 1 to n .) It can be shown

that this norm is also consistent, in spite of the fact that it is not induced by a pair of vector norms, i.e., it is not derived from a formula of the form (1.7); see Exercise 5. However, it does not satisfy some of the other properties of the p -norms. For example, the Frobenius norm of the identity matrix is not equal to one. To avoid these difficulties, *we will only use the term matrix norm for a norm that is induced by two norms as in the definition (1.7)*. Thus, we will not consider the Frobenius norm to be a proper matrix norm, according to our conventions, even though it is consistent.

The following equalities satisfied by the matrix norms defined above lead to alternative definitions that are often easier to work with:

$$\|A\|_1 = \max_{j=1, \dots, m} \sum_{i=1}^n |a_{ij}|, \quad (1.9)$$

$$\|A\|_\infty = \max_{i=1, \dots, n} \sum_{j=1}^m |a_{ij}|, \quad (1.10)$$

$$\|A\|_2 = [\rho(A^H A)]^{1/2} = [\rho(AA^H)]^{1/2}, \quad (1.11)$$

$$\|A\|_F = [\text{tr}(A^H A)]^{1/2} = [\text{tr}(AA^H)]^{1/2}. \quad (1.12)$$

As will be shown later, the eigenvalues of $A^H A$ are nonnegative. Their square roots are called *singular values* of A and are denoted by $\sigma_i, i = 1, \dots, m$. Thus, the relation (1.11) states that $\|A\|_2$ is equal to σ_1 , the largest singular value of A .

Example 1.1 From the relation (1.11), it is clear that the spectral radius $\rho(A)$ is equal to the 2-norm of a matrix when the matrix is Hermitian. However, it is not a matrix norm in general. For example, the first property of norms is not satisfied, since for

$$A = \begin{pmatrix} 0 & 1 \\ 0 & 0 \end{pmatrix},$$

we have $\rho(A) = 0$ while $A \neq 0$. Also, the triangle inequality is not satisfied for the pair A , and $B = A^T$ where A is defined above. Indeed,

$$\rho(A + B) = 1 \quad \text{while} \quad \rho(A) + \rho(B) = 0.$$

SUBSPACES, RANGE, AND KERNEL

1.6

A subspace of \mathbb{C}^n is a subset of \mathbb{C}^n that is also a complex vector space. The set of all linear combinations of a set of vectors $G = \{a_1, a_2, \dots, a_q\}$ of \mathbb{C}^n is a vector subspace called the linear span of G ,

$$\text{span}\{G\} = \text{span}\{a_1, a_2, \dots, a_q\}$$

$$= \left\{ z \in \mathbb{C}^n \mid z = \sum_{i=1}^q \alpha_i a_i; \{\alpha_i\}_{i=1, \dots, q} \in \mathbb{C}^q \right\}.$$

If the a_i 's are linearly independent, then each vector of $\text{span}\{G\}$ admits a unique expression as a linear combination of the a_i 's. The set G is then called a *basis* of the subspace $\text{span}\{G\}$.

Given two vector subspaces S_1 and S_2 , their *sum* S is a subspace defined as the set of all vectors that are equal to the sum of a vector of S_1 and a vector of S_2 . The intersection of two subspaces is also a subspace. If the intersection of S_1 and S_2 is reduced to $\{0\}$, then the sum of S_1 and S_2 is called their *direct sum* and is denoted by $S = S_1 \oplus S_2$. When S is equal to \mathbb{C}^n , then every vector x of \mathbb{C}^n can be written in a unique way as the sum of an element x_1 of S_1 and an element x_2 of S_2 . The transformation P that maps x into x_1 is a linear transformation that is *idempotent*, i.e., such that $P^2 = P$. It is called a *projector* onto S_1 along S_2 .

Two important subspaces that are associated with a matrix A of $\mathbb{C}^{n \times m}$ are its *range*, defined by

$$\text{Ran}(A) = \{Ax \mid x \in \mathbb{C}^m\}, \quad (1.13)$$

and its *kernel* or *null space*

$$\text{Ker}(A) = \{x \in \mathbb{C}^m \mid Ax = 0\}.$$

The range of A is clearly equal to the linear *span* of its columns. The *rank* of a matrix is equal to the dimension of the range of A , i.e., to the number of linearly independent columns. This *column rank* is equal to the *row rank*, the number of linearly independent rows of A . A matrix in $\mathbb{C}^{n \times m}$ is of *full rank* when its rank is equal to the smallest of m and n .

A subspace S is said to be *invariant* under a (square) matrix A whenever $AS \subset S$. In particular for any eigenvalue λ of A the subspace $\text{Ker}(A - \lambda I)$ is invariant under A . The subspace $\text{Ker}(A - \lambda I)$ is called the *eigenspace* associated with λ and consists of all the eigenvectors of A associated with λ , in addition to the zero-vector.

ORTHOGONAL VECTORS AND SUBSPACES

1.7

A set of vectors $G = \{a_1, a_2, \dots, a_r\}$ is said to be *orthogonal* if

$$(a_i, a_j) = 0 \quad \text{when} \quad i \neq j.$$

It is *orthonormal* if, in addition, every vector of G has a 2-norm equal to unity. A vector that is orthogonal to all the vectors of a subspace S is said to be orthogonal to this subspace. The set of all the vectors that are orthogonal to S is a vector subspace called the *orthogonal complement* of S and denoted by S^\perp . The space \mathbb{C}^n is the direct sum of S and its orthogonal complement. Thus, any vector x can be written in a unique fashion as the sum of a vector in S and a vector in S^\perp . The operator which maps x into its component in the subspace S is the *orthogonal projector* onto S .

Every subspace admits an orthonormal basis which is obtained by taking any basis and “orthonormalizing” it. The orthonormalization can be achieved by an algorithm known as the Gram-Schmidt process which we now describe. Given a set of linearly independent vectors $\{x_1, x_2, \dots, x_r\}$, first normalize the vector x_1 , which means divide it by its 2-norm, to obtain the scaled vector q_1 of norm unity. Then x_2 is orthogonalized against the vector q_1 by subtracting from x_2 a multiple of q_1 to make the resulting vector orthogonal to q_1 , i.e.,

$$x_2 \leftarrow x_2 - (x_2, q_1)q_1.$$

The resulting vector is again normalized to yield the second vector q_2 . The i -th step of the Gram-Schmidt process consists of orthogonalizing the vector x_i against all previous vectors q_j .

ALGORITHM 1.1: Gram-Schmidt

1. Compute $r_{11} := \|x_1\|_2$. If $r_{11} = 0$ Stop, else compute $q_1 := x_1/r_{11}$.
 2. For $j = 2, \dots, r$ Do:
 3. Compute $r_{ij} := (x_j, q_i)$, for $i = 1, 2, \dots, j - 1$
 4. $\hat{q} := x_j - \sum_{i=1}^{j-1} r_{ij}q_i$
 5. $r_{jj} := \|\hat{q}\|_2$,
 6. If $r_{jj} = 0$ then Stop, else $q_j := \hat{q}/r_{jj}$
 7. EndDo
-

It is easy to prove that the above algorithm will not break down, i.e., all r steps will be completed if and only if the set of vectors x_1, x_2, \dots, x_r is linearly independent. From lines 4 and 5, it is clear that at every step of the algorithm the following relation holds:

$$x_j = \sum_{i=1}^j r_{ij}q_i.$$

If $X = [x_1, x_2, \dots, x_r]$, $Q = [q_1, q_2, \dots, q_r]$, and if R denotes the $r \times r$ upper triangular matrix whose nonzero elements are the r_{ij} defined in the algorithm, then the above relation can be written as

$$X = QR. \tag{1.14}$$

This is called the QR decomposition of the $n \times r$ matrix X . From what was said above, the QR decomposition of a matrix exists whenever the column vectors of X form a linearly independent set of vectors.

The above algorithm is the standard Gram-Schmidt process. There are alternative formulations of the algorithm which have better numerical properties. The best known of these is the Modified Gram-Schmidt (MGS) algorithm.

ALGORITHM 1.2: Modified Gram-Schmidt

1. Define $r_{11} := \|x_1\|_2$. If $r_{11} = 0$ Stop, else $q_1 := x_1/r_{11}$.
2. For $j = 2, \dots, r$ Do:

3. Define $\hat{q} := x_j$
4. For $i = 1, \dots, j - 1$, Do:
 5. $r_{ij} := (\hat{q}, q_i)$
 6. $\hat{q} := \hat{q} - r_{ij}q_i$
 7. EndDo
8. Compute $r_{jj} := \|\hat{q}\|_2$,
9. If $r_{jj} = 0$ then Stop, else $q_j := \hat{q}/r_{jj}$
10. EndDo

Yet another alternative for orthogonalizing a sequence of vectors is the Householder algorithm. This technique uses Householder *reflectors*, i.e., matrices of the form

$$P = I - 2ww^T, \quad (1.15)$$

in which w is a vector of 2-norm unity. Geometrically, the vector Px represents a mirror image of x with respect to the hyperplane $\text{span}\{w\}^\perp$.

To describe the Householder orthogonalization process, the problem can be formulated as that of finding a QR factorization of a given $n \times m$ matrix X . For any vector x , the vector w for the Householder transformation (1.15) is selected in such a way that

$$Px = \alpha e_1,$$

where α is a scalar. Writing $(I - 2ww^T)x = \alpha e_1$ yields

$$2w^T x w = x - \alpha e_1. \quad (1.16)$$

This shows that the desired w is a multiple of the vector $x - \alpha e_1$,

$$w = \pm \frac{x - \alpha e_1}{\|x - \alpha e_1\|_2}.$$

For (1.16) to be satisfied, we must impose the condition

$$2(x - \alpha e_1)^T x = \|x - \alpha e_1\|_2^2$$

which gives $2(\|x\|_1^2 - \alpha \xi_1) = \|x\|_2^2 - 2\alpha \xi_1 + \alpha^2$, where $\xi_1 \equiv e_1^T x$ is the first component of the vector x . Therefore, it is necessary that

$$\alpha = \pm \|x\|_2.$$

In order to avoid that the resulting vector w be small, it is customary to take

$$\alpha = -\text{sign}(\xi_1)\|x\|_2,$$

which yields

$$w = \frac{x + \text{sign}(\xi_1)\|x\|_2 e_1}{\|x + \text{sign}(\xi_1)\|x\|_2 e_1\|_2}. \quad (1.17)$$

Given an $n \times m$ matrix, its first column can be transformed to a multiple of the column e_1 , by premultiplying it by a Householder matrix P_1 ,

$$X_1 \equiv P_1 X, \quad X_1 e_1 = \alpha e_1.$$

Assume, inductively, that the matrix X has been transformed in $k - 1$ successive steps into

the partially upper triangular form

$$X_k \equiv P_{k-1} \cdots P_1 X_1 = \begin{pmatrix} x_{11} & x_{12} & x_{13} & \cdots & \cdots & \cdots & x_{1m} \\ & x_{22} & x_{23} & \cdots & \cdots & \cdots & x_{2m} \\ & & x_{33} & \cdots & \cdots & \cdots & x_{3m} \\ & & & \ddots & \cdots & \cdots & \vdots \\ & & & & x_{kk} & \cdots & \vdots \\ & & & & & x_{k+1,k} & \cdots & x_{k+1,m} \\ & & & & & \vdots & \vdots & \vdots \\ & & & & & & x_{n,k} & \cdots & x_{n,m} \end{pmatrix}.$$

This matrix is upper triangular up to column number $k - 1$. To advance by one step, it must be transformed into one which is upper triangular up the k -th column, leaving the previous columns in the same form. To leave the first $k - 1$ columns unchanged, select a w vector which has zeros in positions 1 through $k - 1$. So the next Householder reflector matrix is defined as

$$P_k = I - 2w_k w_k^T, \quad (1.18)$$

in which the vector w_k is defined as

$$w_k = \frac{z}{\|z\|_2}, \quad (1.19)$$

where the components of the vector z are given by

$$z_i = \begin{cases} 0 & \text{if } i < k \\ \beta + x_{ii} & \text{if } i = k \\ x_{ik} & \text{if } i > k \end{cases} \quad (1.20)$$

with

$$\beta = \text{sign}(x_{kk}) \times \left(\sum_{i=k}^n x_{ik}^2 \right)^{1/2}. \quad (1.21)$$

We note in passing that the premultiplication of a matrix X by a Householder transform requires only a rank-one update since,

$$(I - 2w w^T)X = X - w v^T \quad \text{where } v = 2X^T w.$$

Therefore, the Householder matrices need not, and should not, be explicitly formed. In addition, the vectors w need not be explicitly scaled.

Assume now that $m - 1$ Householder transforms have been applied to a certain matrix

X of dimension $n \times m$, to reduce it into the upper triangular form,

$$X_m \equiv P_{m-1}P_{m-2} \dots P_1 X = \begin{pmatrix} x_{11} & x_{12} & x_{13} & \cdots & x_{1m} \\ & x_{22} & x_{23} & \cdots & x_{2m} \\ & & x_{33} & \cdots & x_{3m} \\ & & & \ddots & \vdots \\ & & & & x_{m,m} \\ & & & & 0 \\ & & & & \vdots \\ & & & & \vdots \end{pmatrix}. \quad (1.22)$$

Recall that our initial goal was to obtain a QR factorization of X . We now wish to recover the Q and R matrices from the P_k 's and the above matrix. If we denote by P the product of the P_i on the left-side of (1.22), then (1.22) becomes

$$PX = \begin{pmatrix} R \\ O \end{pmatrix}, \quad (1.23)$$

in which R is an $m \times m$ upper triangular matrix, and O is an $(n - m) \times m$ zero block. Since P is unitary, its inverse is equal to its transpose and, as a result,

$$X = P^T \begin{pmatrix} R \\ O \end{pmatrix} = P_1 P_2 \dots P_{m-1} \begin{pmatrix} R \\ O \end{pmatrix}.$$

If E_m is the matrix of size $n \times m$ which consists of the first m columns of the identity matrix, then the above equality translates into

$$X = P^T E_m R.$$

The matrix $Q = P^T E_m$ represents the m first columns of P^T . Since

$$Q^T Q = E_m^T P P^T E_m = I,$$

Q and R are the matrices sought. In summary,

$$X = QR,$$

in which R is the triangular matrix obtained from the Householder reduction of X (see (1.22) and (1.23)) and

$$Qe_j = P_1 P_2 \dots P_{m-1} e_j.$$

ALGORITHM 1.3: Householder Orthogonalization

1. Define $X = [x_1, \dots, x_m]$
 2. For $k = 1, \dots, m$ Do:
 3. If $k > 1$ compute $r_k := P_{k-1} P_{k-2} \dots P_1 x_k$
 4. Compute w_k using (1.19), (1.20), (1.21)
 5. Compute $r_k := P_k r_k$ with $P_k = I - 2w_k w_k^T$
 6. Compute $q_k = P_1 P_2 \dots P_k e_k$
 7. EndDo
-

Note that line 6 can be omitted since the q_i are not needed in the execution of the next steps. It must be executed only when the matrix Q is needed at the completion of the algorithm. Also, the operation in line 5 consists only of zeroing the components $k + 1, \dots, n$ and updating the k -th component of r_k . In practice, a work vector can be used for r_k and its nonzero components after this step can be saved into an upper triangular matrix. Since the components 1 through k of the vector w_k are zero, the upper triangular matrix R can be saved in those zero locations which would otherwise be unused.

CANONICAL FORMS OF MATRICES

1.8

This section discusses the reduction of square matrices into matrices that have simpler forms, such as diagonal, bidiagonal, or triangular. Reduction means a transformation that preserves the eigenvalues of a matrix.

DEFINITION 1.2 Two matrices A and B are said to be similar if there is a nonsingular matrix X such that

$$A = XBX^{-1}.$$

The mapping $B \rightarrow A$ is called a similarity transformation.

It is clear that *similarity* is an equivalence relation. Similarity transformations preserve the eigenvalues of matrices. An eigenvector u_B of B is transformed into the eigenvector $u_A = Xu_B$ of A . In effect, a similarity transformation amounts to representing the matrix B in a different basis.

We now introduce some terminology.

1. An eigenvalue λ of A has *algebraic multiplicity* μ , if it is a root of multiplicity μ of the characteristic polynomial.
2. If an eigenvalue is of algebraic multiplicity one, it is said to be *simple*. A nonsimple eigenvalue is *multiple*.
3. The *geometric multiplicity* γ of an eigenvalue λ of A is the maximum number of independent eigenvectors associated with it. In other words, the geometric multiplicity γ is the dimension of the eigenspace $\text{Ker}(A - \lambda I)$.
4. A matrix is *derogatory* if the geometric multiplicity of at least one of its eigenvalues is larger than one.
5. An eigenvalue is *semisimple* if its algebraic multiplicity is equal to its geometric multiplicity. An eigenvalue that is not semisimple is called *defective*.

Often, $\lambda_1, \lambda_2, \dots, \lambda_p$ ($p \leq n$) are used to denote the *distinct* eigenvalues of A . It is easy to show that the characteristic polynomials of two similar matrices are identical; see Exercise 9. Therefore, the eigenvalues of two similar matrices are equal and so are their algebraic multiplicities. Moreover, if v is an eigenvector of B , then Xv is an eigenvector

of A and, conversely, if y is an eigenvector of A then $X^{-1}y$ is an eigenvector of B . As a result the number of independent eigenvectors associated with a given eigenvalue is the same for two similar matrices, i.e., their geometric multiplicity is also the same.

1.8.1 REDUCTION TO THE DIAGONAL FORM

The simplest form in which a matrix can be reduced is undoubtedly the diagonal form. Unfortunately, this reduction is not always possible. A matrix that can be reduced to the diagonal form is called *diagonalizable*. The following theorem characterizes such matrices.

THEOREM 1.1 *A matrix of dimension n is diagonalizable if and only if it has n linearly independent eigenvectors.*

Proof. A matrix A is diagonalizable if and only if there exists a nonsingular matrix X and a diagonal matrix D such that $A = XDX^{-1}$, or equivalently $AX = XD$, where D is a diagonal matrix. This is equivalent to saying that n linearly independent vectors exist — the n column-vectors of X — such that $Ax_i = d_ix_i$. Each of these column-vectors is an eigenvector of A . ■

A matrix that is diagonalizable has only semisimple eigenvalues. Conversely, if all the eigenvalues of a matrix A are semisimple, then A has n eigenvectors. It can be easily shown that these eigenvectors are linearly independent; see Exercise 2. As a result, we have the following proposition.

PROPOSITION 1.4 *A matrix is diagonalizable if and only if all its eigenvalues are semisimple.*

Since every simple eigenvalue is semisimple, an immediate corollary of the above result is: When A has n distinct eigenvalues, then it is diagonalizable.

1.8.2 THE JORDAN CANONICAL FORM

From the theoretical viewpoint, one of the most important canonical forms of matrices is the well known Jordan form. A full development of the steps leading to the Jordan form is beyond the scope of this book. Only the main theorem is stated. Details, including the proof, can be found in standard books of linear algebra such as [117]. In the following, m_i refers to the algebraic multiplicity of the individual eigenvalue λ_i and l_i is the *index* of the eigenvalue, i.e., the smallest integer for which $\text{Ker}(A - \lambda_i I)^{l_i+1} = \text{Ker}(A - \lambda_i I)^{l_i}$.

THEOREM 1.2 *Any matrix A can be reduced to a block diagonal matrix consisting of p diagonal blocks, each associated with a distinct eigenvalue λ_i . Each of these diagonal blocks has itself a block diagonal structure consisting of γ_i sub-blocks, where γ_i is the geometric multiplicity of the eigenvalue λ_i . Each of the sub-blocks, referred to as a Jordan*

block, is an upper bidiagonal matrix of size not exceeding $l_i \leq m_i$, with the constant λ_i on the diagonal and the constant one on the super diagonal.

The i -th diagonal block, $i = 1, \dots, p$, is known as the i -th Jordan submatrix (sometimes “Jordan Box”). The Jordan submatrix number i starts in column $j_i \equiv m_1 + m_2 + \dots + m_{i-1} + 1$. Thus,

$$X^{-1}AX = J = \begin{pmatrix} J_1 & & & & \\ & J_2 & & & \\ & & \ddots & & \\ & & & J_i & \\ & & & & \ddots & \\ & & & & & & J_p \end{pmatrix},$$

where each J_i is associated with λ_i and is of size m_i the algebraic multiplicity of λ_i . It has itself the following structure,

$$J_i = \begin{pmatrix} J_{i1} & & & \\ & J_{i2} & & \\ & & \ddots & \\ & & & J_{i\gamma_i} \end{pmatrix} \text{ with } J_{ik} = \begin{pmatrix} \lambda_i & 1 & & \\ & \ddots & \ddots & \\ & & \lambda_i & 1 \\ & & & \lambda_i \end{pmatrix}.$$

Each of the blocks J_{ik} corresponds to a different eigenvector associated with the eigenvalue λ_i . Its size l_i is the index of λ_i .

1.8.3 THE SCHUR CANONICAL FORM

Here, it will be shown that any matrix is unitarily similar to an upper triangular matrix. The only result needed to prove the following theorem is that any vector of 2-norm one can be completed by $n - 1$ additional vectors to form an orthonormal basis of \mathbb{C}^n .

THEOREM 1.3 For any square matrix A , there exists a unitary matrix Q such that

$$Q^H A Q = R$$

is upper triangular.

Proof. The proof is by induction over the dimension n . The result is trivial for $n = 1$. Assume that it is true for $n - 1$ and consider any matrix A of size n . The matrix admits at least one eigenvector u that is associated with an eigenvalue λ . Also assume without loss of generality that $\|u\|_2 = 1$. First, complete the vector u into an orthonormal set, i.e., find an $n \times (n - 1)$ matrix V such that the $n \times n$ matrix $U = [u, V]$ is unitary. Then $AU = [\lambda u, AV]$ and hence,

$$U^H A U = \begin{bmatrix} u^H \\ V^H \end{bmatrix} [\lambda u, AV] = \begin{pmatrix} \lambda & u^H AV \\ 0 & V^H AV \end{pmatrix}. \quad (1.24)$$

Now use the induction hypothesis for the $(n - 1) \times (n - 1)$ matrix $B = V^H AV$: There exists an $(n - 1) \times (n - 1)$ unitary matrix Q_1 such that $Q_1^H B Q_1 = R_1$ is upper triangular.

Define the $n \times n$ matrix

$$\hat{Q}_1 = \begin{pmatrix} 1 & 0 \\ 0 & Q_1 \end{pmatrix}$$

and multiply both members of (1.24) by \hat{Q}_1^H from the left and \hat{Q}_1 from the right. The resulting matrix is clearly upper triangular and this shows that the result is true for A , with $Q = \hat{Q}_1 U$ which is a unitary $n \times n$ matrix. ■

A simpler proof that uses the Jordan canonical form and the QR decomposition is the subject of Exercise 7. Since the matrix R is triangular and similar to A , its diagonal elements are equal to the eigenvalues of A ordered in a certain manner. In fact, it is easy to extend the proof of the theorem to show that this factorization can be obtained with *any order* for the eigenvalues. Despite its simplicity, the above theorem has far-reaching consequences, some of which will be examined in the next section.

It is important to note that for any $k \leq n$, the subspace spanned by the first k columns of Q is invariant under A . Indeed, the relation $AQ = QR$ implies that for $1 \leq j \leq k$, we have

$$Aq_j = \sum_{i=1}^{i=j} r_{ij} q_i.$$

If we let $Q_k = [q_1, q_2, \dots, q_k]$ and if R_k is the principal leading submatrix of dimension k of R , the above relation can be rewritten as

$$AQ_k = Q_k R_k,$$

which is known as the partial Schur decomposition of A . The simplest case of this decomposition is when $k = 1$, in which case q_1 is an eigenvector. The vectors q_i are usually called Schur vectors. Schur vectors are not unique and depend, in particular, on the order chosen for the eigenvalues.

A slight variation on the Schur canonical form is the quasi-Schur form, also called the real Schur form. Here, diagonal blocks of size 2×2 are allowed in the upper triangular matrix R . The reason for this is to avoid complex arithmetic when the original matrix is real. A 2×2 block is associated with each complex conjugate pair of eigenvalues of the matrix.

Example 1.2 Consider the 3×3 matrix

$$A = \begin{pmatrix} 1 & 10 & 0 \\ -1 & 3 & 1 \\ -1 & 0 & 1 \end{pmatrix}.$$

The matrix A has the pair of complex conjugate eigenvalues

$$2.4069 \dots \pm i \times 3.2110 \dots$$

and the real eigenvalue 0.1863 The standard (complex) Schur form is given by the pair of matrices

$$V = \begin{pmatrix} 0.3381 - 0.8462i & 0.3572 - 0.1071i & 0.1749 \\ 0.3193 - 0.0105i & -0.2263 - 0.6786i & -0.6214 \\ 0.1824 + 0.1852i & -0.2659 - 0.5277i & 0.7637 \end{pmatrix}$$

and

$$S = \begin{pmatrix} 2.4069 + 3.2110i & 4.6073 - 4.7030i & -2.3418 - 5.2330i \\ 0 & 2.4069 - 3.2110i & -2.0251 - 1.2016i \\ 0 & 0 & 0.1863 \end{pmatrix}.$$

It is possible to avoid complex arithmetic by using the quasi-Schur form which consists of the pair of matrices

$$U = \begin{pmatrix} -0.9768 & 0.1236 & 0.1749 \\ -0.0121 & 0.7834 & -0.6214 \\ 0.2138 & 0.6091 & 0.7637 \end{pmatrix}$$

and

$$R = \begin{pmatrix} 1.3129 & -7.7033 & 6.0407 \\ 1.4938 & 3.5008 & -1.3870 \\ 0 & 0 & 0.1863 \end{pmatrix}.$$

We conclude this section by pointing out that the Schur and the quasi-Schur forms of a given matrix are in no way unique. In addition to the dependence on the ordering of the eigenvalues, any column of Q can be multiplied by a complex sign $e^{i\theta}$ and a new corresponding R can be found. For the quasi-Schur form, there are infinitely many ways to select the 2×2 blocks, corresponding to applying arbitrary rotations to the columns of Q associated with these blocks.

1.8.4 APPLICATION TO POWERS OF MATRICES

The analysis of many numerical techniques is based on understanding the behavior of the successive powers A^k of a given matrix A . In this regard, the following theorem plays a fundamental role in numerical linear algebra, more particularly in the analysis of iterative methods.

THEOREM 1.4 *The sequence A^k , $k = 0, 1, \dots$, converges to zero if and only if $\rho(A) < 1$.*

Proof. To prove the necessary condition, assume that $A^k \rightarrow 0$ and consider u_1 a unit eigenvector associated with an eigenvalue λ_1 of maximum modulus. We have

$$A^k u_1 = \lambda_1^k u_1,$$

which implies, by taking the 2-norms of both sides,

$$|\lambda_1^k| = \|A^k u_1\|_2 \rightarrow 0.$$

This shows that $\rho(A) = |\lambda_1| < 1$.

The Jordan canonical form must be used to show the sufficient condition. Assume that $\rho(A) < 1$. Start with the equality

$$A^k = X J^k X^{-1}.$$

To prove that A^k converges to zero, it is sufficient to show that J^k converges to zero. An important observation is that J^k preserves its block form. Therefore, it is sufficient to prove that each of the Jordan blocks converges to zero. Each block is of the form

$$J_i = \lambda_i I + E_i$$

where E_i is a nilpotent matrix of index l_i , i.e., $E_i^{l_i} = 0$. Therefore, for $k \geq l_i$,

$$J_i^k = \sum_{j=0}^{l_i-1} \frac{k!}{j!(k-j)!} \lambda_i^{k-j} E_i^j.$$

Using the triangle inequality for any norm and taking $k \geq l_i$ yields

$$\|J_i^k\| \leq \sum_{j=0}^{l_i-1} \frac{k!}{j!(k-j)!} |\lambda_i|^{k-j} \|E_i^j\|.$$

Since $|\lambda_i| < 1$, each of the terms in this *finite* sum converges to zero as $k \rightarrow \infty$. Therefore, the matrix J_i^k converges to zero. ■

An equally important result is stated in the following theorem.

THEOREM 1.5 *The series*

$$\sum_{k=0}^{\infty} A^k$$

converges if and only if $\rho(A) < 1$. Under this condition, $I - A$ is nonsingular and the limit of the series is equal to $(I - A)^{-1}$.

Proof. The first part of the theorem is an immediate consequence of Theorem 1.4. Indeed, if the series converges, then $\|A^k\| \rightarrow 0$. By the previous theorem, this implies that $\rho(A) < 1$. To show that the converse is also true, use the equality

$$I - A^{k+1} = (I - A)(I + A + A^2 + \dots + A^k)$$

and exploit the fact that since $\rho(A) < 1$, then $I - A$ is nonsingular, and therefore,

$$(I - A)^{-1}(I - A^{k+1}) = I + A + A^2 + \dots + A^k.$$

This shows that the series converges since the left-hand side will converge to $(I - A)^{-1}$. In addition, it also shows the second part of the theorem. ■

Another important consequence of the Jordan canonical form is a result that relates the spectral radius of a matrix to its matrix norm.

THEOREM 1.6 For any matrix norm $\|\cdot\|$, we have

$$\lim_{k \rightarrow \infty} \|A^k\|^{1/k} = \rho(A).$$

Proof. The proof is a direct application of the Jordan canonical form and is the subject of Exercise 10. ■

NORMAL AND HERMITIAN MATRICES

1.9

This section examines specific properties of normal matrices and Hermitian matrices, including some optimality properties related to their spectra. The most common normal matrices that arise in practice are Hermitian or skew-Hermitian.

1.9.1 NORMAL MATRICES

By definition, a matrix is said to be normal if it commutes with its transpose conjugate, i.e., if it satisfies the relation

$$A^H A = A A^H. \tag{1.25}$$

An immediate property of normal matrices is stated in the following lemma.

LEMMA 1.1 *If a normal matrix is triangular, then it is a diagonal matrix.*

Proof. Assume, for example, that A is upper triangular and normal. Compare the first diagonal element of the left-hand side matrix of (1.25) with the corresponding element of the matrix on the right-hand side. We obtain that

$$|a_{11}|^2 = \sum_{j=1}^n |a_{1j}|^2,$$

which shows that the elements of the first row are zeros except for the diagonal one. The same argument can now be used for the second row, the third row, and so on to the last row, to show that $a_{ij} = 0$ for $i \neq j$. ■

A consequence of this lemma is the following important result.

THEOREM 1.7 *A matrix is normal if and only if it is unitarily similar to a diagonal matrix.*

Proof. It is straightforward to verify that a matrix which is unitarily similar to a diagonal matrix is normal. We now prove that any normal matrix A is unitarily similar to a diagonal

matrix. Let $A = QRQ^H$ be the Schur canonical form of A where Q is unitary and R is upper triangular. By the normality of A ,

$$QR^H Q^H QRQ^H = QRQ^H QR^H Q^H$$

or,

$$QR^H RQ^H = QRR^H Q^H.$$

Upon multiplication by Q^H on the left and Q on the right, this leads to the equality $R^H R = RR^H$ which means that R is normal, and according to the previous lemma this is only possible if R is diagonal. ■

Thus, any normal matrix is diagonalizable and admits an orthonormal basis of eigenvectors, namely, the column vectors of Q .

The following result will be used in a later chapter. The question that is asked is: Assuming that any eigenvector of a matrix A is also an eigenvector of A^H , is A normal? If A had a full set of eigenvectors, then the result is true and easy to prove. Indeed, if V is the $n \times n$ matrix of common eigenvectors, then $AV = VD_1$ and $A^H V = VD_2$, with D_1 and D_2 diagonal. Then, $AA^H V = VD_1 D_2$ and $A^H AV = VD_2 D_1$ and, therefore, $AA^H = A^H A$. It turns out that the result is true in general, i.e., independently of the number of eigenvectors that A admits.

LEMMA 1.2 *A matrix A is normal if and only if each of its eigenvectors is also an eigenvector of A^H .*

Proof. If A is normal, then its left and right eigenvectors are identical, so the sufficient condition is trivial. Assume now that a matrix A is such that each of its eigenvectors v_i , $i = 1, \dots, k$, with $k \leq n$ is an eigenvector of A^H . For each eigenvector v_i of A , $Av_i = \lambda_i v_i$, and since v_i is also an eigenvector of A^H , then $A^H v_i = \mu v_i$. Observe that $(A^H v_i, v_i) = \mu(v_i, v_i)$ and because $(A^H v_i, v_i) = (v_i, Av_i) = \bar{\lambda}_i(v_i, v_i)$, it follows that $\mu = \bar{\lambda}_i$. Next, it is proved by contradiction that there are no elementary divisors. Assume that the contrary is true for λ_i . Then, the first principal vector u_i associated with λ_i is defined by

$$(A - \lambda_i I)u_i = v_i.$$

Taking the inner product of the above relation with v_i , we obtain

$$(Au_i, v_i) = \lambda_i(u_i, v_i) + (v_i, v_i). \quad (1.26)$$

On the other hand, it is also true that

$$(Au_i, v_i) = (u_i, A^H v_i) = (u_i, \bar{\lambda}_i v_i) = \lambda_i(u_i, v_i). \quad (1.27)$$

A result of (1.26) and (1.27) is that $(v_i, v_i) = 0$ which is a contradiction. Therefore, A has a full set of eigenvectors. This leads to the situation discussed just before the lemma, from which it is concluded that A must be normal. ■

Clearly, Hermitian matrices are a particular case of normal matrices. Since a normal matrix satisfies the relation $A = QDQ^H$, with D diagonal and Q unitary, the eigenvalues of A are the diagonal entries of D . Therefore, if these entries are real it is clear that $A^H = A$. This is restated in the following corollary.

COROLLARY 1.1 *A normal matrix whose eigenvalues are real is Hermitian.*

As will be seen shortly, the converse is also true, i.e., a Hermitian matrix has real eigenvalues.

An eigenvalue λ of any matrix satisfies the relation

$$\lambda = \frac{(Au, u)}{(u, u)},$$

where u is an associated eigenvector. Generally, one might consider the complex scalars

$$\mu(x) = \frac{(Ax, x)}{(x, x)}, \quad (1.28)$$

defined for any nonzero vector in \mathbb{C}^n . These ratios are known as *Rayleigh quotients* and are important both for theoretical and practical purposes. The set of all possible Rayleigh quotients as x runs over \mathbb{C}^n is called the *field of values* of A . This set is clearly bounded since each $|\mu(x)|$ is bounded by the 2-norm of A , i.e., $|\mu(x)| \leq \|A\|_2$ for all x .

If a matrix is normal, then any vector x in \mathbb{C}^n can be expressed as

$$\sum_{i=1}^n \xi_i q_i,$$

where the vectors q_i form an orthogonal basis of eigenvectors, and the expression for $\mu(x)$ becomes

$$\mu(x) = \frac{(Ax, x)}{(x, x)} = \frac{\sum_{k=1}^n \lambda_k |\xi_k|^2}{\sum_{k=1}^n |\xi_k|^2} \equiv \sum_{k=1}^n \beta_k \lambda_k, \quad (1.29)$$

where

$$0 \leq \beta_i = \frac{|\xi_i|^2}{\sum_{k=1}^n |\xi_k|^2} \leq 1, \quad \text{and} \quad \sum_{i=1}^n \beta_i = 1.$$

From a well known characterization of convex hulls established by Hausdorff (Hausdorff's convex hull theorem), this means that the set of all possible Rayleigh quotients as x runs over all of \mathbb{C}^n is equal to the convex hull of the λ_i 's. This leads to the following theorem which is stated without proof.

THEOREM 1.8 *The field of values of a normal matrix is equal to the convex hull of its spectrum.*

The next question is whether or not this is also true for nonnormal matrices and the answer is no: The convex hull of the eigenvalues and the field of values of a nonnormal matrix are different in general. As a generic example, one can take any nonsymmetric real matrix which has real eigenvalues only. In this case, the convex hull of the spectrum is a real interval but its field of values will contain imaginary values. See Exercise 12 for another example. It has been shown (Hausdorff) that the field of values of a matrix is a convex set. Since the eigenvalues are members of the field of values, their convex hull is contained in the field of values. This is summarized in the following proposition.

PROPOSITION 1.5 *The field of values of an arbitrary matrix is a convex set which contains the convex hull of its spectrum. It is equal to the convex hull of the spectrum when the matrix is normal.*

1.9.2 HERMITIAN MATRICES

A first result on Hermitian matrices is the following.

THEOREM 1.9 *The eigenvalues of a Hermitian matrix are real, i.e., $\sigma(A) \subset \mathbb{R}$.*

Proof. Let λ be an eigenvalue of A and u an associated eigenvector of 2-norm unity. Then

$$\lambda = (Au, u) = (u, Au) = \overline{(Au, u)} = \bar{\lambda},$$

which is the stated result. ■

It is not difficult to see that if, in addition, the matrix is real, then the eigenvectors can be chosen to be real; see Exercise 21. Since a Hermitian matrix is normal, the following is a consequence of Theorem 1.7.

THEOREM 1.10 *Any Hermitian matrix is unitarily similar to a real diagonal matrix.*

In particular a Hermitian matrix admits a set of orthonormal eigenvectors that form a basis of \mathbb{C}^n .

In the proof of Theorem 1.8 we used the fact that the inner products (Au, u) are real. Generally, it is clear that any Hermitian matrix is such that (Ax, x) is real for any vector $x \in \mathbb{C}^n$. It turns out that the converse is also true, i.e., it can be shown that if (Az, z) is real for all vectors z in \mathbb{C}^n , then the matrix A is Hermitian; see Exercise 15.

Eigenvalues of Hermitian matrices can be characterized by optimality properties of the Rayleigh quotients (1.28). The best known of these is the min-max principle. We now label all the eigenvalues of A in descending order:

$$\lambda_1 \geq \lambda_2 \geq \cdots \geq \lambda_n.$$

Here, the eigenvalues are not necessarily distinct and they are repeated, each according to its multiplicity. In the following theorem, known as the *Min-Max Theorem*, S represents a generic subspace of \mathbb{C}^n .

THEOREM 1.11 *The eigenvalues of a Hermitian matrix A are characterized by the relation*

$$\lambda_k = \min_{S, \dim(S)=n-k+1} \max_{x \in S, x \neq 0} \frac{(Ax, x)}{(x, x)}. \quad (1.30)$$

Proof. Let $\{q_i\}_{i=1,\dots,n}$ be an orthonormal basis of \mathbb{C}^n consisting of eigenvectors of A associated with $\lambda_1, \dots, \lambda_n$ respectively. Let S_k be the subspace spanned by the first k of these vectors and denote by $\mu(S)$ the maximum of $(Ax, x)/(x, x)$ over all nonzero vectors of a subspace S . Since the dimension of S_k is k , a well known theorem of linear algebra shows that its intersection with any subspace S of dimension $n - k + 1$ is not reduced to $\{0\}$, i.e., there is vector x in $S \cap S_k$. For this $x = \sum_{i=1}^k \xi_i q_i$, we have

$$\frac{(Ax, x)}{(x, x)} = \frac{\sum_{i=1}^k \lambda_i |\xi_i|^2}{\sum_{i=1}^k |\xi_i|^2} \geq \lambda_k$$

so that $\mu(S) \geq \lambda_k$.

Consider, on the other hand, the particular subspace S_0 of dimension $n - k + 1$ which is spanned by q_k, \dots, q_n . For each vector x in this subspace, we have

$$\frac{(Ax, x)}{(x, x)} = \frac{\sum_{i=k}^n \lambda_i |\xi_i|^2}{\sum_{i=k}^n |\xi_i|^2} \leq \lambda_k$$

so that $\mu(S_0) \leq \lambda_k$. In other words, as S runs over all the $(n - k + 1)$ -dimensional subspaces, $\mu(S)$ is always $\geq \lambda_k$ and there is at least one subspace S_0 for which $\mu(S_0) \leq \lambda_k$. This shows the desired result. ■

The above result is often called the Courant-Fisher min-max principle or theorem. As a particular case, the largest eigenvalue of A satisfies

$$\lambda_1 = \max_{x \neq 0} \frac{(Ax, x)}{(x, x)}. \quad (1.31)$$

Actually, there are four different ways of rewriting the above characterization. The second formulation is

$$\lambda_k = \max_{S, \dim(S)=k} \min_{x \in S, x \neq 0} \frac{(Ax, x)}{(x, x)} \quad (1.32)$$

and the two other ones can be obtained from (1.30) and (1.32) by simply relabeling the eigenvalues increasingly instead of decreasingly. Thus, with our labeling of the eigenvalues in descending order, (1.32) tells us that the smallest eigenvalue satisfies

$$\lambda_n = \min_{x \neq 0} \frac{(Ax, x)}{(x, x)}, \quad (1.33)$$

with λ_n replaced by λ_1 if the eigenvalues are relabeled increasingly.

In order for all the eigenvalues of a Hermitian matrix to be positive, it is necessary and sufficient that

$$(Ax, x) > 0, \quad \forall x \in \mathbb{C}^n, \quad x \neq 0.$$

Such a matrix is called *positive definite*. A matrix which satisfies $(Ax, x) \geq 0$ for any x is said to be *positive semidefinite*. In particular, the matrix $A^H A$ is semipositive definite for any rectangular matrix, since

$$(A^H A x, x) = (Ax, Ax) \geq 0, \quad \forall x.$$

Similarly, AA^H is also a Hermitian semipositive definite matrix. The square roots of the eigenvalues of $A^H A$ for a general rectangular matrix A are called the *singular values* of

A and are denoted by σ_i . In Section 1.5, we have stated without proof that the 2-norm of any matrix A is equal to the largest singular value σ_1 of A . This is now an obvious fact, because

$$\|A\|_2^2 = \max_{x \neq 0} \frac{\|Ax\|_2^2}{\|x\|_2^2} = \max_{x \neq 0} \frac{(Ax, Ax)}{(x, x)} = \max_{x \neq 0} \frac{(A^H Ax, x)}{(x, x)} = \sigma_1^2$$

which results from (1.31).

Another characterization of eigenvalues, known as the Courant characterization, is stated in the next theorem. In contrast with the min-max theorem, this property is recursive in nature.

THEOREM 1.12 *The eigenvalue λ_i and the corresponding eigenvector q_i of a Hermitian matrix are such that*

$$\lambda_1 = \frac{(Aq_1, q_1)}{(q_1, q_1)} = \max_{x \in \mathbb{C}^n, x \neq 0} \frac{(Ax, x)}{(x, x)}$$

and for $k > 1$,

$$\lambda_k = \frac{(Aq_k, q_k)}{(q_k, q_k)} = \max_{x \neq 0, q_1^H x = \dots = q_{k-1}^H x = 0} \frac{(Ax, x)}{(x, x)}. \quad (1.34)$$

In other words, the maximum of the Rayleigh quotient over a subspace that is orthogonal to the first $k - 1$ eigenvectors is equal to λ_k and is achieved for the eigenvector q_k associated with λ_k . The proof follows easily from the expansion (1.29) of the Rayleigh quotient.

NONNEGATIVE MATRICES, M-MATRICES

1.10

Nonnegative matrices play a crucial role in the theory of matrices. They are important in the study of convergence of iterative methods and arise in many applications including economics, queuing theory, and chemical engineering.

A *nonnegative matrix* is simply a matrix whose entries are nonnegative. More generally, a partial order relation can be defined on the set of matrices.

DEFINITION 1.3 *Let A and B be two $n \times m$ matrices. Then*

$$A \leq B$$

if by definition, $a_{ij} \leq b_{ij}$ for $1 \leq i \leq n, 1 \leq j \leq m$. If O denotes the $n \times m$ zero matrix, then A is nonnegative if $A \geq O$, and positive if $A > O$. Similar definitions hold in which “positive” is replaced by “negative”.

The binary relation “ \leq ” imposes only a *partial* order on $\mathbb{R}^{n \times m}$ since two arbitrary matrices in $\mathbb{R}^{n \times m}$ are not necessarily comparable by this relation. For the remainder of this section,

we now assume that only square matrices are involved. The next proposition lists a number of rather trivial properties regarding the partial order relation just defined.

PROPOSITION 1.6 *The following properties hold.*

1. The relation \leq for matrices is reflexive ($A \leq A$), antisymmetric (if $A \leq B$ and $B \leq A$, then $A = B$), and transitive (if $A \leq B$ and $B \leq C$, then $A \leq C$).
2. If A and B are nonnegative, then so is their product AB and their sum $A + B$.
3. If A is nonnegative, then so is A^k .
4. If $A \leq B$, then $A^T \leq B^T$.
5. If $O \leq A \leq B$, then $\|A\|_1 \leq \|B\|_1$ and similarly $\|A\|_\infty \leq \|B\|_\infty$.

The proof of these properties is left as Exercise 23.

A matrix is said to be *reducible* if there is a permutation matrix P such that PAP^T is block upper triangular. Otherwise, it is *irreducible*. An important result concerning nonnegative matrices is the following theorem known as the Perron-Frobenius theorem.

THEOREM 1.13 *Let A be a real $n \times n$ nonnegative irreducible matrix. Then $\lambda \equiv \rho(A)$, the spectral radius of A , is a simple eigenvalue of A . Moreover, there exists an eigenvector u with positive elements associated with this eigenvalue.*

A relaxed version of this theorem allows the matrix to be reducible but the conclusion is somewhat weakened in the sense that the elements of the eigenvectors are only guaranteed to be *nonnegative*.

Next, a useful property is established.

PROPOSITION 1.7 *Let A, B, C be nonnegative matrices, with $A \leq B$. Then*

$$AC \leq BC \quad \text{and} \quad CA \leq CB.$$

Proof. Consider the first inequality only, since the proof for the second is identical. The result that is claimed translates into

$$\sum_{k=1}^n a_{ik}c_{kj} \leq \sum_{k=1}^n b_{ik}c_{kj}, \quad 1 \leq i, j \leq n,$$

which is clearly true by the assumptions. ■

A consequence of the proposition is the following corollary.

COROLLARY 1.2 *Let A and B be two nonnegative matrices, with $A \leq B$. Then*

$$A^k \leq B^k, \quad \forall k \geq 0. \tag{1.35}$$

Proof. The proof is by induction. The inequality is clearly true for $k = 0$. Assume that (1.35) is true for k . According to the previous proposition, multiplying (1.35) from the left by A results in

$$A^{k+1} \leq AB^k. \tag{1.36}$$

Now, it is clear that if $B \geq 0$, then also $B^k \geq 0$, by Proposition 1.6. We now multiply both sides of the inequality $A \leq B$ by B^k to the right, and obtain

$$AB^k \leq B^{k+1}. \quad (1.37)$$

The inequalities (1.36) and (1.37) show that $A^{k+1} \leq B^{k+1}$, which completes the induction proof. ■

A theorem which has important consequences on the analysis of iterative methods will now be stated.

THEOREM 1.14 *Let A and B be two square matrices that satisfy the inequalities*

$$0 \leq A \leq B. \quad (1.38)$$

Then

$$\rho(A) \leq \rho(B). \quad (1.39)$$

Proof. The proof is based on the following equality stated in Theorem 1.6

$$\rho(X) = \lim_{k \rightarrow \infty} \|X^k\|^{1/k}$$

for any matrix norm. Choosing the 1–norm, for example, we have from the last property in Proposition 1.6

$$\rho(A) = \lim_{k \rightarrow \infty} \|A^k\|_1^{1/k} \leq \lim_{k \rightarrow \infty} \|B^k\|_1^{1/k} = \rho(B)$$

which completes the proof. ■

THEOREM 1.15 *Let B be a nonnegative matrix. Then $\rho(B) < 1$ if and only if $I - B$ is nonsingular and $(I - B)^{-1}$ is nonnegative.*

Proof. Define $C = I - B$. If it is assumed that $\rho(B) < 1$, then by Theorem 1.5, $C = I - B$ is nonsingular and

$$C^{-1} = (I - B)^{-1} = \sum_{i=0}^{\infty} B^i. \quad (1.40)$$

In addition, since $B \geq 0$, all the powers of B as well as their sum in (1.40) are also nonnegative.

To prove the sufficient condition, assume that C is nonsingular and that its inverse is nonnegative. By the Perron-Frobenius theorem, there is a nonnegative eigenvector u associated with $\rho(B)$, which is an eigenvalue, i.e.,

$$Bu = \rho(B)u$$

or, equivalently,

$$C^{-1}u = \frac{1}{1 - \rho(B)}u.$$

Since u and C^{-1} are nonnegative, and $I - B$ is nonsingular, this shows that $1 - \rho(B) > 0$, which is the desired result. ■

DEFINITION 1.4 A matrix is said to be an *M-matrix* if it satisfies the following four properties:

1. $a_{i,i} > 0$ for $i = 1, \dots, n$.
2. $a_{i,j} \leq 0$ for $i \neq j, i, j = 1, \dots, n$.
3. A is nonsingular.
4. $A^{-1} \geq 0$.

In reality, the four conditions in the above definition are somewhat redundant and equivalent conditions that are more rigorous will be given later. Let A be any matrix which satisfies properties (1) and (2) in the above definition and let D be the diagonal of A . Since $D > 0$,

$$A = D - (D - A) = D (I - (I - D^{-1}A)).$$

Now define

$$B \equiv I - D^{-1}A.$$

Using the previous theorem, $I - B = D^{-1}A$ is nonsingular and $(I - B)^{-1} = A^{-1}D \geq 0$ if and only if $\rho(B) < 1$. It is now easy to see that conditions (3) and (4) of Definition 1.4 can be replaced by the condition $\rho(B) < 1$.

THEOREM 1.16 Let a matrix A be given such that

1. $a_{i,i} > 0$ for $i = 1, \dots, n$.
2. $a_{i,j} \leq 0$ for $i \neq j, i, j = 1, \dots, n$.

Then A is an *M-matrix* if and only if

3. $\rho(B) < 1$, where $B = I - D^{-1}A$.

Proof. From the above argument, an immediate application of Theorem 1.15 shows that properties (3) and (4) of the above definition are equivalent to $\rho(B) < 1$, where $B = I - C$ and $C = D^{-1}A$. In addition, C is nonsingular iff A is and C^{-1} is nonnegative iff A is. ■

The next theorem shows that the condition (1) in Definition 1.4 is implied by the other three.

THEOREM 1.17 Let a matrix A be given such that

1. $a_{i,j} \leq 0$ for $i \neq j, i, j = 1, \dots, n$.
2. A is nonsingular.
3. $A^{-1} \geq 0$.

Then

4. $a_{i,i} > 0$ for $i = 1, \dots, n$, i.e., A is an *M-matrix*.
5. $\rho(B) < 1$ where $B = I - D^{-1}A$.

Proof. Define $C \equiv A^{-1}$. Writing that $(AC)_{ii} = 1$ yields

$$\sum_{k=1}^n a_{ik}c_{ki} = 1$$

which gives

$$a_{ii}c_{ii} = 1 - \sum_{\substack{k=1 \\ k \neq i}}^n a_{ik}c_{ki}.$$

Since $a_{ik}c_{ki} \leq 0$ for all k , the right-hand side is ≥ 1 and since $c_{ii} \geq 0$, then $a_{ii} > 0$. The second part of the result now follows immediately from an application of the previous theorem. ■

Finally, this useful result follows.

THEOREM 1.18 *Let A, B be two matrices which satisfy*

1. $A \leq B$.
2. $b_{ij} \leq 0$ for all $i \neq j$.

Then if A is an M -matrix, so is the matrix B .

Proof. Assume that A is an M -matrix and let D_X denote the diagonal of a matrix X . The matrix D_B is positive because

$$D_B \geq D_A > 0.$$

Consider now the matrix $I - D_B^{-1}B$. Since $A \leq B$, then

$$D_A - A \geq D_B - B \geq 0$$

which, upon multiplying through by D_A^{-1} , yields

$$I - D_A^{-1}A \geq D_A^{-1}(D_B - B) \geq D_B^{-1}(D_B - B) = I - D_B^{-1}B \geq 0.$$

Since the matrices $I - D_B^{-1}B$ and $I - D_A^{-1}A$ are nonnegative, Theorems 1.14 and 1.16 imply that

$$\rho(I - D_B^{-1}B) \leq \rho(I - D_A^{-1}A) < 1.$$

This establishes the result by using Theorem 1.16 once again. ■

POSITIVE-DEFINITE MATRICES

1.11

A real matrix is said to be *positive definite* or *positive real* if

$$(Au, u) > 0, \quad \forall u \in \mathbb{R}^n, u \neq 0. \quad (1.41)$$

It must be emphasized that this definition is only useful when formulated entirely for real variables. Indeed, if u were not restricted to be real, then assuming that (Au, u) is real for all u complex would imply that A is Hermitian; see Exercise 15. If, in addition to Definition 1.41, A is symmetric (real), then A is said to be *Symmetric Positive Definite* (SPD). Similarly, if A is Hermitian, then A is said to be *Hermitian Positive Definite* (HPD).

Some properties of HPD matrices were seen in Section 1.9, in particular with regards to their eigenvalues. Now the more general case where A is non-Hermitian and positive definite is considered.

We begin with the observation that any square matrix (real or complex) can be decomposed as

$$A = H + iS, \quad (1.42)$$

in which

$$H = \frac{1}{2}(A + A^H) \quad (1.43)$$

$$S = \frac{1}{2i}(A - A^H). \quad (1.44)$$

Note that both H and S are Hermitian while the matrix iS in the decomposition (1.42) is skew-Hermitian. The matrix H in the decomposition is called the *Hermitian part* of A , while the matrix iS is the *skew-Hermitian part* of A . The above decomposition is the analogue of the decomposition of a complex number z into $z = x + iy$,

$$x = \Re(z) = \frac{1}{2}(z + \bar{z}), \quad y = \Im(z) = \frac{1}{2i}(z - \bar{z}).$$

When A is real and u is a real vector then (Au, u) is real and, as a result, the decomposition (1.42) immediately gives the equality

$$(Au, u) = (Hu, u). \quad (1.45)$$

This results in the following theorem.

THEOREM 1.19 *Let A be a real positive definite matrix. Then A is nonsingular. In addition, there exists a scalar $\alpha > 0$ such that*

$$(Au, u) \geq \alpha \|u\|_2^2, \quad (1.46)$$

for any real vector u .

Proof. The first statement is an immediate consequence of the definition of positive definiteness. Indeed, if A were singular, then there would be a nonzero vector such that $Au = 0$ and as a result $(Au, u) = 0$ for this vector, which would contradict (1.41). We now prove the second part of the theorem. From (1.45) and the fact that A is positive definite, we conclude that H is HPD. Hence, from (1.33) based on the min-max theorem, we get

$$\min_{u \neq 0} \frac{(Au, u)}{(u, u)} = \min_{u \neq 0} \frac{(Hu, u)}{(u, u)} \geq \lambda_{\min}(H) > 0.$$

Taking $\alpha \equiv \lambda_{\min}(H)$ yields the desired inequality (1.46). ■

A simple yet important result which locates the eigenvalues of A in terms of the spectra

of H and S can now be proved.

THEOREM 1.20 *Let A be any square (possibly complex) matrix and let $H = \frac{1}{2}(A + A^H)$ and $S = \frac{1}{2i}(A - A^H)$. Then any eigenvalue λ_j of A is such that*

$$\lambda_{\min}(H) \leq \Re(\lambda_j) \leq \lambda_{\max}(H) \quad (1.47)$$

$$\lambda_{\min}(S) \leq \Im(\lambda_j) \leq \lambda_{\max}(S). \quad (1.48)$$

Proof. When the decomposition (1.42) is applied to the Rayleigh quotient of the eigenvector u_j associated with λ_j , we obtain

$$\lambda_j = (Au_j, u_j) = (Hu_j, u_j) + i(Su_j, u_j), \quad (1.49)$$

assuming that $\|u_j\|_2 = 1$. This leads to

$$\Re(\lambda_j) = (Hu_j, u_j)$$

$$\Im(\lambda_j) = (Su_j, u_j).$$

The result follows using properties established in Section 1.9. ■

Thus, the eigenvalues of a matrix are contained in a rectangle defined by the eigenvalues of its Hermitian part and its non-Hermitian part. In the particular case where A is real, then iS is skew-Hermitian and its eigenvalues form a set that is symmetric with respect to the real axis in the complex plane. Indeed, in this case, iS is real and its eigenvalues come in conjugate pairs.

Note that all the arguments herein are based on the field of values and, therefore, they provide ways to localize the eigenvalues of A from knowledge of the field of values. However, this approximation can be inaccurate in some cases.

Example 1.3 Consider the matrix

$$A = \begin{pmatrix} 1 & 1 \\ 10^4 & 1 \end{pmatrix}.$$

The eigenvalues of A are -99 and 101 . Those of H are $1 \pm (10^4 + 1)/2$ and those of iS are $\pm i(10^4 - 1)/2$.

When a matrix B is Symmetric Positive Definite, the mapping

$$x, y \rightarrow (x, y)_B \equiv (Bx, y) \quad (1.50)$$

from $\mathbb{C}^n \times \mathbb{C}^n$ to \mathbb{C} is a proper inner product on \mathbb{C}^n , in the sense defined in Section 1.4. The associated norm is often referred to as the *energy norm*. Sometimes, it is possible to find an appropriate HPD matrix B which makes a given matrix A Hermitian, i.e., such that

$$(Ax, y)_B = (x, Ay)_B, \quad \forall x, y$$

although A is a non-Hermitian matrix with respect to the Euclidean inner product. The simplest examples are $A = B^{-1}C$ and $A = CB$, where C is Hermitian and B is Hermitian Positive Definite.

PROJECTION OPERATORS

1.12

Projection operators or *projectors* play an important role in numerical linear algebra, particularly in iterative methods for solving various matrix problems. This section introduces these operators from a purely algebraic point of view and gives a few of their important properties.

1.12.1 RANGE AND NULL SPACE OF A PROJECTOR

A projector P is any linear mapping from \mathbb{C}^n to itself which is idempotent, i.e., such that

$$P^2 = P.$$

A few simple properties follow from this definition. First, if P is a projector, then so is $(I - P)$, and the following relation holds,

$$\text{Ker}(P) = \text{Ran}(I - P).$$

In addition, the two subspaces $\text{Ker}(P)$ and $\text{Ran}(P)$ intersect only at the element zero. Indeed, if a vector x belongs to $\text{Ran}(P)$, then $Px = x$, by the idempotence property. If it is also in $\text{Ker}(P)$, then $Px = 0$. Hence, $x = Px = 0$ which proves the result. Moreover, every element of \mathbb{C}^n can be written as $x = Px + (I - P)x$. Therefore, the space \mathbb{C}^n can be decomposed as the direct sum

$$\mathbb{C}^n = \text{Ker}(P) \oplus \text{Ran}(P).$$

Conversely, every pair of subspaces M and S which forms a direct sum of \mathbb{C}^n defines a unique projector such that $\text{Ran}(P) = M$ and $\text{Ker}(P) = S$. This associated projector P maps an element x of \mathbb{C}^n into the component x_1 , where x_1 is the M -component in the unique decomposition $x = x_1 + x_2$ associated with the direct sum.

In fact, this association is unique, that is, an arbitrary projector P can be entirely determined by the given of two subspaces: (1) The range M of P , and (2) its null space S which is also the range of $I - P$. For any x , the vector Px satisfies the conditions,

$$\begin{aligned} Px &\in M \\ x - Px &\in S. \end{aligned}$$

The linear mapping P is said to project x *onto* M and *along* or *parallel* to the subspace S . If P is of rank m , then the range of $I - P$ is of dimension $n - m$. Therefore, it is natural to define S through its orthogonal complement $L = S^\perp$ which has dimension m . The above conditions that define $u = Px$ for any x become

$$u \in M \tag{1.51}$$

$$x - u \perp L. \tag{1.52}$$

These equations define a projector P *onto* M and *orthogonal* to the subspace L . The first statement, (1.51), establishes the m degrees of freedom, while the second, (1.52), gives

the m constraints that define Px from these degrees of freedom. The general definition of projectors is illustrated in Figure 1.1.

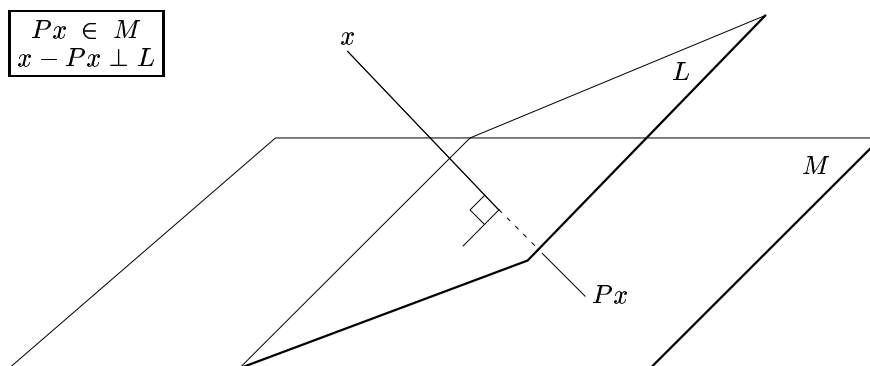

Figure 1.1 Projection of x onto M and orthogonal to L .

The question now is: Given two arbitrary subspaces, M and L both of dimension m , is it always possible to define a projector onto M orthogonal to L through the conditions (1.51) and (1.52)? The following lemma answers this question.

LEMMA 1.3 Given two subspaces M and L of the same dimension m , the following two conditions are mathematically equivalent.

- i.* No nonzero vector of M is orthogonal to L ;
- ii.* For any x in \mathbb{C}^n there is a unique vector u which satisfies the conditions (1.51) and (1.52).

Proof. The first condition states that any vector which is in M and also orthogonal to L must be the zero vector. It is equivalent to the condition

$$M \cap L^\perp = \{0\}.$$

Since L is of dimension m , L^\perp is of dimension $n - m$ and the above condition is equivalent to the condition that

$$\mathbb{C}^n = M \oplus L^\perp. \quad (1.53)$$

This in turn is equivalent to the statement that for any x , there exists a unique pair of vectors u, w such that

$$x = u + w,$$

where u belongs to M , and $w = x - u$ belongs to L^\perp , a statement which is identical with *ii*. ■

In summary, given two subspaces M and L , satisfying the condition $M \cap L^\perp = \{0\}$, there is a projector P onto M orthogonal to L , which defines the projected vector u of any vector

x from equations (1.51) and (1.52). This projector is such that

$$\text{Ran}(P) = M, \quad \text{Ker}(P) = L^\perp.$$

In particular, the condition $Px = 0$ translates into $x \in \text{Ker}(P)$ which means that $x \in L^\perp$. The converse is also true. Hence, the following useful property,

$$Px = 0 \quad \text{iff} \quad x \perp L. \quad (1.54)$$

1.12.2 MATRIX REPRESENTATIONS

Two bases are required to obtain a matrix representation of a general projector: a basis $V = [v_1, \dots, v_m]$ for the subspace $M = \text{Ran}(P)$ and a second one $W = [w_1, \dots, w_m]$ for the subspace L . These two bases are *biorthogonal* when

$$(v_i, w_j) = \delta_{ij}. \quad (1.55)$$

In matrix form this means $W^H V = I$. Since Px belongs to M , let Vy be its representation in the V basis. The constraint $x - Px \perp L$ is equivalent to the condition,

$$((x - Vy), w_j) = 0 \quad \text{for } j = 1, \dots, m.$$

In matrix form, this can be rewritten as

$$W^H(x - Vy) = 0. \quad (1.56)$$

If the two bases are biorthogonal, then it follows that $y = W^H x$. Therefore, in this case, $Px = VW^H x$, which yields the matrix representation of P ,

$$P = VW^H. \quad (1.57)$$

In case the bases V and W are not biorthogonal, then it is easily seen from the condition (1.56) that

$$P = V(W^H V)^{-1} W^H. \quad (1.58)$$

If we assume that no vector of M is orthogonal to L , then it can be shown that the $m \times m$ matrix $W^H V$ is nonsingular.

1.12.3 ORTHOGONAL AND OBLIQUE PROJECTORS

An important class of projectors is obtained in the case when the subspace L is equal to M , i.e., when

$$\text{Ker}(P) = \text{Ran}(P)^\perp.$$

Then, the projector P is said to be the *orthogonal projector* onto M . A projector that is not orthogonal is *oblique*. Thus, an orthogonal projector is defined through the following requirements satisfied for any vector x ,

$$Px \in M \quad \text{and} \quad (I - P)x \perp M \quad (1.59)$$

or equivalently,

$$Px \in M \quad \text{and} \quad ((I - P)x, y) = 0 \quad \forall y \in M.$$

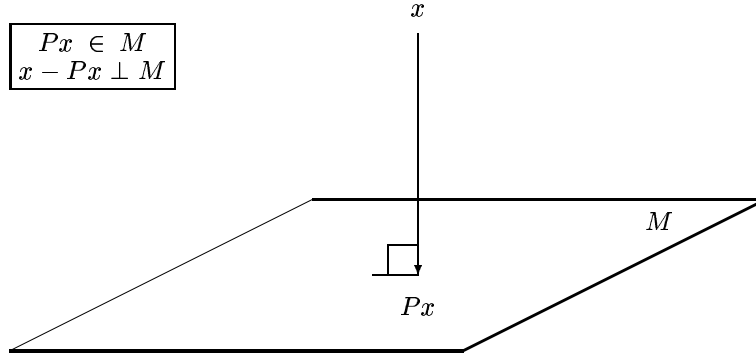

Figure 1.2 Orthogonal projection of x onto a subspace M .

It is interesting to consider the mapping P^H defined as the adjoint of P

$$(P^H x, y) = (x, Py), \quad \forall x, \forall y. \tag{1.60}$$

First note that P^H is also a projector because for all x and y ,

$$((P^H)^2 x, y) = (P^H x, Py) = (x, P^2 y) = (x, Py) = (P^H x, y).$$

A consequence of the relation (1.60) is

$$\text{Ker}(P^H) = \text{Ran}(P)^\perp \tag{1.61}$$

$$\text{Ker}(P) = \text{Ran}(P^H)^\perp. \tag{1.62}$$

The above relations lead to the following proposition.

PROPOSITION 1.8 *A projector is orthogonal if and only if it is Hermitian.*

Proof. By definition, an orthogonal projector is one for which $\text{Ker}(P) = \text{Ran}(P)^\perp$. Therefore, by (1.61), if P is Hermitian, then it is orthogonal. Conversely, if P is orthogonal, then (1.61) implies $\text{Ker}(P) = \text{Ker}(P^H)$ while (1.62) implies $\text{Ran}(P) = \text{Ran}(P^H)$. Since P^H is a projector and since projectors are uniquely determined by their range and null spaces, this implies that $P = P^H$. ■

Given any unitary $n \times m$ matrix V whose columns form an orthonormal basis of $M = \text{Ran}(P)$, we can represent P by the matrix $P = VV^H$. This is a particular case of the matrix representation of projectors (1.57). In addition to being idempotent, the linear mapping associated with this matrix satisfies the characterization given above, i.e.,

$$VV^H x \in M \quad \text{and} \quad (I - VV^H)x \in M^\perp.$$

It is important to note that this representation of the orthogonal projector P is not unique. In fact, any orthonormal basis V will give a different representation of P in the above form. As

a consequence for any two orthogonal bases V_1, V_2 of M , we must have $V_1 V_1^H = V_2 V_2^H$, an equality which can also be verified independently; see Exercise 26.

1.12.4 PROPERTIES OF ORTHOGONAL PROJECTORS

When P is an orthogonal projector, then the two vectors Px and $(I - P)x$ in the decomposition $x = Px + (I - P)x$ are orthogonal. The following relation results:

$$\|x\|_2^2 = \|Px\|_2^2 + \|(I - P)x\|_2^2.$$

A consequence of this is that for any x ,

$$\|Px\|_2 \leq \|x\|_2.$$

Thus, the maximum of $\|Px\|_2/\|x\|_2$, for all x in \mathbb{C}^n does not exceed one. In addition the value one is reached for any element in $\text{Ran}(P)$. Therefore,

$$\|P\|_2 = 1$$

for any orthogonal projector P .

An orthogonal projector has only two eigenvalues: zero or one. Any vector of the range of P is an eigenvector associated with the eigenvalue one. Any vector of the null-space is obviously an eigenvector associated with the eigenvalue zero.

Next, an important optimality property of orthogonal projectors is established.

THEOREM 1.21 *Let P be the orthogonal projector onto a subspace M . Then for any given vector x in \mathbb{C}^n , the following is true:*

$$\min_{y \in M} \|x - y\|_2 = \|x - Px\|_2. \quad (1.63)$$

Proof. Let y be any vector of M and consider the square of its distance from x . Since $x - Px$ is orthogonal to M to which $Px - y$ belongs, then

$$\|x - y\|_2^2 = \|x - Px + (Px - y)\|_2^2 = \|x - Px\|_2^2 + \|(Px - y)\|_2^2.$$

Therefore, $\|x - y\|_2 \geq \|x - Px\|_2$ for all y in M . This establishes the result by noticing that the minimum is reached for $y = Px$. ■

By expressing the conditions that define $y^* \equiv Px$ for an orthogonal projector P onto a subspace M , it is possible to reformulate the above result in the form of necessary and sufficient conditions which enable us to determine the best approximation to a given vector x in the least-squares sense.

COROLLARY 1.3 *Let a subspace M , and a vector x in \mathbb{C}^n be given. Then*

$$\min_{y \in M} \|x - y\|_2 = \|x - y^*\|_2, \quad (1.64)$$

if and only if the following two conditions are satisfied,

$$\begin{cases} y^* & \in M \\ x - y^* & \perp M. \end{cases}$$

BASIC CONCEPTS IN LINEAR SYSTEMS

1.13

Linear systems are among the most important and common problems encountered in scientific computing. From the theoretical point of view, the problem is rather easy and explicit solutions using determinants exist. In addition, it is well understood when a solution exists, when it does not, and when there are infinitely many solutions. However, the numerical viewpoint is far more complex. Approximations may be available but it may be difficult to estimate how accurate they are. This clearly will depend on the data at hand, i.e., primarily on the coefficient matrix. This section gives a very brief overview of the existence theory as well as the sensitivity of the solutions.

1.13.1 EXISTENCE OF A SOLUTION

Consider the *linear system*

$$Ax = b. \quad (1.65)$$

Here, x is termed the *unknown* and b the *right-hand side*. When solving the linear system (1.65), we distinguish three situations.

Case 1 The matrix A is nonsingular. There is a unique solution given by $x = A^{-1}b$.

Case 2 The matrix A is singular and $b \in \text{Ran}(A)$. Since $b \in \text{Ran}(A)$, there is an x_0 such that $Ax_0 = b$. Then $x_0 + v$ is also a solution for any v in $\text{Ker}(A)$. Since $\text{Ker}(A)$ is at least one-dimensional, there are infinitely many solutions.

Case 3 The matrix A is singular and $b \notin \text{Ran}(A)$. There are no solutions.

Example 1.4 The simplest illustration of the above three cases is with small diagonal matrices. Let

$$A = \begin{pmatrix} 2 & 0 \\ 0 & 4 \end{pmatrix} \quad b = \begin{pmatrix} 1 \\ 8 \end{pmatrix}.$$

Then A is nonsingular and there is a unique x given by

$$x = \begin{pmatrix} 0.5 \\ 2 \end{pmatrix}.$$

Now let

$$A = \begin{pmatrix} 2 & 0 \\ 0 & 0 \end{pmatrix}, \quad b = \begin{pmatrix} 1 \\ 0 \end{pmatrix}.$$

Then A is singular and, as is easily seen, $b \in \text{Ran}(A)$. For example, a particular element x_0 such that $Ax_0 = b$ is $x_0 = \begin{pmatrix} 0.5 \\ 0 \end{pmatrix}$. The null space of A consists of all vectors whose first component is zero, i.e., all vectors of the form $\begin{pmatrix} 0 \\ \alpha \end{pmatrix}$. Therefore, there are infinitely many

solution which are given by

$$x(\alpha) = \begin{pmatrix} 0.5 \\ \alpha \end{pmatrix} \quad \forall \alpha.$$

Finally, let A be the same as in the previous case, but define the right-hand side as

$$b = \begin{pmatrix} 1 \\ 1 \end{pmatrix}.$$

In this case there are no solutions because the second equation cannot be satisfied.

1.13.2 PERTURBATION ANALYSIS

Consider the linear system (1.65) where A is an $n \times n$ nonsingular matrix. Given any matrix E , the matrix $A(\epsilon) = A + \epsilon E$ is nonsingular for ϵ small enough, i.e., for $\epsilon \leq \alpha$ where α is some small number; see Exercise 32. Assume that we perturb the data in the above system, i.e., that we perturb the matrix A by ϵE and the right-hand side b by ϵe . The solution $x(\epsilon)$ of the perturbed system satisfies the equation,

$$(A + \epsilon E)x(\epsilon) = b + \epsilon e. \quad (1.66)$$

Let $\delta(\epsilon) = x(\epsilon) - x$. Then,

$$\begin{aligned} (A + \epsilon E)\delta(\epsilon) &= (b + \epsilon e) - (A + \epsilon E)x \\ &= \epsilon(e - Ex) \\ \delta(\epsilon) &= \epsilon(A + \epsilon E)^{-1}(e - Ex). \end{aligned}$$

As an immediate result, the function $x(\epsilon)$ is differentiable at $\epsilon = 0$ and its derivative is given by

$$x'(0) = \lim_{\epsilon \rightarrow 0} \frac{\delta(\epsilon)}{\epsilon} = A^{-1}(e - Ex). \quad (1.67)$$

The size of the derivative of $x(\epsilon)$ is an indication of the size of the variation that the solution $x(\epsilon)$ undergoes when the data, i.e., the pair $[A, b]$ is perturbed in the direction $[E, e]$. In absolute terms, a small variation $[\epsilon E, \epsilon e]$ will cause the solution to vary by roughly $\epsilon x'(0) = \epsilon A^{-1}(e - Ex)$. The relative variation is such that

$$\frac{\|x(\epsilon) - x\|}{\|x\|} \leq \epsilon \|A^{-1}\| \left(\frac{\|e\|}{\|x\|} + \|E\| \right) + o(\epsilon).$$

Using the fact that $\|b\| \leq \|A\|\|x\|$ in the above equation yields

$$\frac{\|x(\epsilon) - x\|}{\|x\|} \leq \epsilon \|A\| \|A^{-1}\| \left(\frac{\|e\|}{\|b\|} + \frac{\|E\|}{\|A\|} \right) + o(\epsilon) \quad (1.68)$$

which relates the relative variation in the solution to the relative sizes of the perturbations. The quantity

$$\kappa(A) = \|A\| \|A^{-1}\|$$

is called the *condition number* of the linear system (1.65) with respect to the norm $\|\cdot\|$. The condition number is relative to a norm. When using the standard norms $\|\cdot\|_p$, $p = 1, \dots, \infty$, it is customary to label $\kappa(A)$ with the same label as the associated norm. Thus,

$$\kappa_p(A) = \|A\|_p \|A^{-1}\|_p.$$

For large matrices, the determinant of a matrix is almost never a good indication of “near” singularity or degree of sensitivity of the linear system. The reason is that $\det(A)$ is the product of the eigenvalues which depends very much on a scaling of a matrix, whereas the condition number of a matrix is scaling-invariant. For example, for $A = \alpha I$ the determinant is $\det(A) = \alpha^n$, which can be very small if $|\alpha| < 1$, whereas $\kappa(A) = 1$ for any of the standard norms.

In addition, small eigenvalues do not always give a good indication of poor conditioning. Indeed, a matrix can have all its eigenvalues equal to one yet be poorly conditioned.

Example 1.5 The simplest example is provided by matrices of the form

$$A_n = I + \alpha e_1 e_n^T$$

for large α . The inverse of A_n is

$$A_n^{-1} = I - \alpha e_1 e_n^T$$

and for the ∞ -norm we have

$$\|A_n\|_\infty = \|A_n^{-1}\|_\infty = 1 + |\alpha|$$

so that

$$\kappa_\infty(A_n) = (1 + |\alpha|)^2.$$

For a large α , this can give a very large condition number, whereas all the eigenvalues of A_n are equal to unity.

When an iterative procedure is used for solving a linear system, we typically face the problem of choosing a good stopping procedure for the algorithm. Often a residual norm,

$$\|r\| = \|b - A\tilde{x}\|$$

is available for some current approximation \tilde{x} and an estimate of the absolute error $\|x - \tilde{x}\|$ or the relative error $\|x - \tilde{x}\|/\|x\|$ is desired. The following simple relation is helpful in this regard,

$$\frac{\|x - \tilde{x}\|}{\|x\|} \leq \kappa(A) \frac{\|r\|}{\|b\|}.$$

It is necessary to have an estimate of the condition number $\kappa(A)$ in order to exploit the above relation.

EXERCISES

1. Verify that the Euclidean inner product defined by (1.4) does indeed satisfy the general definition of inner products on vector spaces.
2. Show that two eigenvectors associated with two distinct eigenvalues are linearly independent. In a more general sense, show that a family of eigenvectors associated with distinct eigenvalues forms a linearly independent family.
3. Show that if λ is any nonzero eigenvalue of the matrix AB , then it is also an eigenvalue of the matrix BA . Start with the particular case where A and B are square and B is nonsingular, then consider the more general case where A, B may be singular or even rectangular (but such that AB and BA are square).
4. Let A be an $n \times n$ orthogonal matrix, i.e., such that $A^H A = D$, where D is a diagonal matrix. Assuming that D is nonsingular, what is the inverse of A ? Assuming that $D > 0$, how can A be transformed into a unitary matrix (by operations on its rows or columns)?
5. Show that the Frobenius norm is consistent. Can this norm be associated to two vector norms via (1.7)? What is the Frobenius norm of a diagonal matrix? What is the p -norm of a diagonal matrix (for any p)?
6. Find the Jordan canonical form of the matrix:

$$A = \begin{pmatrix} 1 & 2 & -4 \\ 0 & 1 & 2 \\ 0 & 0 & 2 \end{pmatrix}.$$

Same question for the matrix obtained by replacing the element a_{33} by 1.

7. Give an alternative proof of Theorem 1.3 on the Schur form by starting from the Jordan canonical form. [Hint: Write $A = XJX^{-1}$ and use the QR decomposition of X .]
8. Show from the definition of determinants used in Section 1.2 that the characteristic polynomial is a polynomial of degree n for an $n \times n$ matrix.
9. Show that the characteristic polynomials of two similar matrices are equal.
10. Show that

$$\lim_{k \rightarrow \infty} \|A^k\|^{1/k} = \rho(A),$$

for any matrix norm. [Hint: Use the Jordan canonical form.]

11. Let X be a nonsingular matrix and, for any matrix norm $\|\cdot\|$, define $\|A\|_X = \|AX\|$. Show that this is indeed a matrix norm. Is this matrix norm consistent? Show the same for $\|XA\|$ and $\|YAX\|$ where Y is also a nonsingular matrix. These norms are not, in general, associated with any vector norms, i.e., they can't be defined by a formula of the form (1.7). Why? What about the particular case $\|A\|' = \|XAX^{-1}\|$?
12. Find the field of values of the matrix

$$A = \begin{pmatrix} 0 & 1 \\ 0 & 0 \end{pmatrix}$$

and verify that it is not equal to the convex hull of its eigenvalues.

13. Show that for a skew-Hermitian matrix S ,

$$\Re(Sx, x) = 0 \quad \text{for any } x \in \mathbb{C}^n.$$

14. Given an arbitrary matrix S , show that if $(Sx, x) = 0$ for all x in \mathbb{C}^n , then it is true that

$$(Sy, z) + (Sz, y) = 0 \quad \forall y, z \in \mathbb{C}^n.$$

[Hint: Expand $(S(y+z), y+z)$.]

15. Using the results of the previous two problems, show that if (Ax, x) is real for all x in \mathbb{C}^n , then A must be Hermitian. Would this result be true if the assumption were to be replaced by: (Ax, x) is real for all real x ? Explain.
16. The definition of a positive definite matrix is that (Ax, x) be real and positive for all real vectors x . Show that this is equivalent to requiring that the Hermitian part of A , namely, $\frac{1}{2}(A + A^H)$, be (Hermitian) positive definite.
17. Let $A_1 = B^{-1}C$ and $A_2 = CB$ where C is a Hermitian matrix and B is a Hermitian Positive Definite matrix. Are A_1 and A_2 Hermitian *in general*? Show that A_1 and A_2 are Hermitian (self-adjoint) with respect to the B -inner product.
18. Let a matrix A be such that $A^H = p(A)$ where p is a polynomial. Show that A is normal. [Hint: Use Lemma 1.2.]
19. Show that A is normal iff its Hermitian and skew-Hermitian parts, as defined in Section 1.11, commute.
20. Let A be a Hermitian matrix and B a Hermitian Positive Definite matrix defining a B -inner product. Show that A is Hermitian (self-adjoint) with respect to the B -inner product if and only if A and B commute. What condition must satisfy B for the same condition to hold in the more general case where A is not Hermitian?
21. Let A be a real symmetric matrix and λ an eigenvalue of A . Show that if u is an eigenvector associated with λ , then so is \bar{u} . As a result, prove that for any eigenvalue of a real symmetric matrix, there is an associated eigenvector which is real.
22. Show that a Hessenberg matrix H such that $h_{j+1,j} \neq 0$, $j = 1, 2, \dots, n-1$, cannot be derogatory.
23. Prove all the properties listed in Proposition 1.6.
24. Let A be an M -matrix and u, v two nonnegative vectors such that $v^T A^{-1} u < 1$. Show that $A - uv^T$ is an M -matrix.
25. Show that if $O \leq A \leq B$ then $O \leq A^T A \leq B^T B$. Conclude that under the same assumption, we have $\|A\|_2 \leq \|B\|_2$.
26. Show that for two orthogonal bases V_1, V_2 of the same subspace M of \mathbb{C}^n we have $V_1 V_1^H x = V_2 V_2^H x$, $\forall x$.
27. What are the eigenvalues of a projector? What about its eigenvectors?
28. Show that if two projectors P_1 and P_2 commute, then their product $P = P_1 P_2$ is a projector. What are the range and kernel of P ?

29. Consider the matrix A of size $n \times n$ and the vector $x \in \mathbb{R}^n$,

$$A = \begin{pmatrix} 1 & -1 & -1 & -1 & \dots & -1 \\ 0 & 1 & -1 & -1 & \dots & -1 \\ 0 & 0 & 1 & -1 & \dots & -1 \\ \vdots & \vdots & \vdots & \ddots & & \vdots \\ \vdots & \vdots & \vdots & \vdots & \ddots & \vdots \\ \vdots & \vdots & \vdots & \vdots & \ddots & \vdots \\ 0 & 0 & 0 & \dots & 0 & 1 \end{pmatrix} \quad x = \begin{pmatrix} 1 \\ 1/2 \\ 1/4 \\ 1/8 \\ \vdots \\ 1/2^{n-1} \end{pmatrix}.$$

- a. Compute Ax , $\|Ax\|_2$, and $\|x\|_2$.
 - b. Show that $\|A\|_2 \geq \sqrt{n}$.
 - c. Give a lower bound for $\kappa_2(A)$.
30. What is the inverse of the matrix A of the previous exercise? Give an expression of $\kappa_1(A)$ and $\kappa_\infty(A)$ based on this.
31. Find a small rank-one perturbation which makes the matrix A in Exercise 29 singular. Derive a lower bound for the singular values of A .
32. Consider a nonsingular matrix A . Given any matrix E , show that there exists α such that the matrix $A(\epsilon) = A + \epsilon E$ is nonsingular for all $\epsilon < \alpha$. What is the largest possible value for α satisfying the condition? [Hint: Consider the eigenvalues of the generalized eigenvalue problem $Au = \lambda Eu$.]

NOTES AND REFERENCES. For additional reading on the material presented in this chapter, see Golub and Van Loan [108], Datta [64], Stewart [202], and Varga [213]. Details on matrix eigenvalue problems can be found in Gantmacher's book [100] and Wilkinson [227]. An excellent treatise of nonnegative matrices is in the book by Varga [213] which remains a good reference on iterative methods more three decades after its first publication. Another book with state-of-the-art coverage on iterative methods up to the very beginning of the 1970s is the book by Young [232] which covers M -matrices and related topics in great detail. For a good overview of the linear algebra aspects of matrix theory and a complete proof of Jordan's canonical form, Halmos [117] is recommended. ■

DISCRETIZATION OF PDES

Partial Differential Equations (PDEs) constitute by far the biggest source of sparse matrix problems. The typical way to solve such equations is to *discretize* them, i.e., to approximate them by equations that involve a finite number of unknowns. The matrix problems that arise from these discretizations are generally large and sparse, i.e., they have very few nonzero entries. There are several different ways to discretize a Partial Differential Equation. The simplest method uses *finite difference* approximations for the partial differential operators. The *Finite Element Method* replaces the original function by a function which has some degree of smoothness over the global domain, but which is piecewise polynomial on simple cells, such as small triangles or rectangles. This method is probably the most general and well understood discretization technique available. In between these two methods, there are a few conservative schemes called *Finite Volume Methods*, which attempt to emulate continuous *conservation laws* of physics. This chapter introduces these three different discretization methods.

PARTIAL DIFFERENTIAL EQUATIONS

2.1

Physical phenomena are often modeled by equations that relate several partial derivatives of physical quantities, such as forces, momentums, velocities, energy, temperature, etc. These equations rarely have a *closed-form* (explicit) solution. In this chapter, a few types of Partial Differential Equations are introduced, which will serve as models throughout the book. Only one- or two-dimensional problems are considered, and the space variables are denoted by x in the case of one-dimensional problems or x_1 and x_2 for two-dimensional problems. In two dimensions, x denotes the “vector” of components (x_1, x_2) .

2.1.1 ELLIPTIC OPERATORS

One of the most common Partial Differential Equations encountered in various areas of engineering is Poisson's equation:

$$\frac{\partial^2 u}{\partial x_1^2} + \frac{\partial^2 u}{\partial x_2^2} = f, \text{ for } x = \begin{pmatrix} x_1 \\ x_2 \end{pmatrix} \text{ in } \Omega \quad (2.1)$$

where Ω is a bounded, open domain in \mathbb{R}^2 . Here, x_1, x_2 are the two space variables.

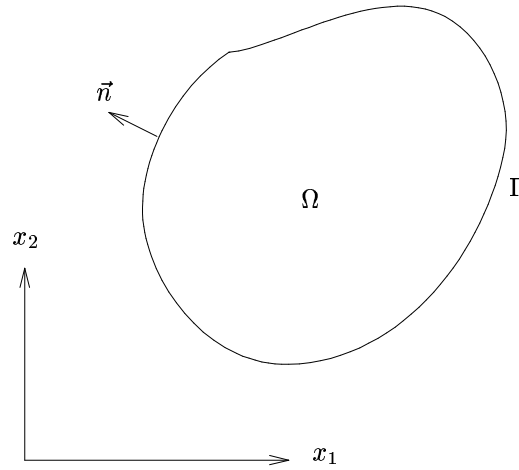

Figure 2.1 Domain Ω for Poisson's equation.

The above equation is to be satisfied only for points that are located at the interior of the domain Ω . Equally important are the conditions that must be satisfied on the *boundary* Γ of Ω . These are termed *boundary conditions*, and they come in three common types:

Dirichlet condition	$u(x) = \phi(x)$
Neumann condition	$\frac{\partial u}{\partial \vec{n}}(x) = 0$
Cauchy condition	$\frac{\partial u}{\partial \vec{n}}(x) + \alpha(x)u(x) = \gamma(x)$

The vector \vec{n} usually refers to a unit vector that is normal to Γ and directed outwards. Note that the Neumann boundary conditions are a particular case of the Cauchy conditions with $\gamma = \alpha = 0$. For a given unit vector, \vec{v} with components v_1 and v_2 , the directional derivative $\partial u / \partial \vec{v}$ is defined by

$$\begin{aligned} \frac{\partial u}{\partial \vec{v}}(x) &= \lim_{h \rightarrow 0} \frac{u(x + h\vec{v}) - u(x)}{h} \\ &= \frac{\partial u}{\partial x_1}(x)v_1 + \frac{\partial u}{\partial x_2}(x)v_2 \end{aligned} \quad (2.2)$$

$$= \nabla u \cdot \vec{v} \quad (2.3)$$

where ∇u is the gradient of u ,

$$\nabla u = \begin{pmatrix} \frac{\partial u}{\partial x_1} \\ \frac{\partial u}{\partial x_2} \end{pmatrix}, \quad (2.4)$$

and the dot in (2.3) indicates a dot product of two vectors in \mathbb{R}^2 .

In reality, Poisson's equation is often a limit case of a time-dependent problem. It can, for example, represent the steady-state temperature distribution in a region Ω when there is a heat source f that is constant with respect to time. The boundary conditions should then model heat loss across the boundary Γ .

The particular case where $f(x) = 0$, i.e., the equation

$$\Delta u = 0,$$

to which boundary conditions must be added, is called the *Laplace equation* and its solutions are called *harmonic functions*.

Many problems in physics have boundary conditions of *mixed type*, e.g., of Dirichlet type in one part of the boundary and of Cauchy type in another. Another observation is that the Neumann conditions do not define the solution uniquely. Indeed, if u is a solution, then so is $u + c$ for any constant c .

The operator

$$\Delta = \frac{\partial^2}{\partial x_1^2} + \frac{\partial^2}{\partial x_2^2}$$

is called the *Laplacian operator* and appears in many models of physical and mechanical phenomena. These models often lead to more general elliptic operators of the form

$$\begin{aligned} L &= \frac{\partial}{\partial x_1} \left(a \frac{\partial}{\partial x_1} \right) + \frac{\partial}{\partial x_2} \left(a \frac{\partial}{\partial x_2} \right) \\ &= \nabla \cdot (a \nabla) \end{aligned} \quad (2.5)$$

where the scalar function a depends on the coordinate and may represent some specific parameter of the medium, such as density, porosity, etc. At this point it may be useful to recall some notation which is widely used in physics and mechanics. The ∇ operator can be considered as a vector consisting of the components $\frac{\partial}{\partial x_1}$ and $\frac{\partial}{\partial x_2}$. When applied to a scalar function u , this operator is nothing but the *gradient* operator, since it yields a vector with the components $\frac{\partial u}{\partial x_1}$ and $\frac{\partial u}{\partial x_2}$ as is shown in (2.4). The dot notation allows dot products of vectors in \mathbb{R}^2 to be defined. These vectors can include partial differential operators. For example, the dot product $\nabla \cdot u$ of ∇ with $u = \begin{pmatrix} u_1 \\ u_2 \end{pmatrix}$ yields the scalar quantity,

$$\frac{\partial u_1}{\partial x_1} + \frac{\partial u_2}{\partial x_2},$$

which is called the *divergence* of the vector function $\vec{u} = \begin{pmatrix} u_1 \\ u_2 \end{pmatrix}$. Applying this *divergence operator* to $u = a \nabla$, where a is a scalar function, yields the L operator in (2.5). The divergence of the vector function \vec{v} is often denoted by $\text{div } \vec{v}$ or $\nabla \cdot \vec{v}$. Thus,

$$\text{div } \vec{v} = \nabla \cdot \vec{v} = \frac{\partial v_1}{\partial x_1} + \frac{\partial v_2}{\partial x_2}.$$

The closely related operator

$$\begin{aligned} L &= \frac{\partial}{\partial x_1} \left(a_1 \frac{\partial}{\partial x_1} \right) + \frac{\partial}{\partial x_2} \left(a_2 \frac{\partial}{\partial x_2} \right) \\ &= \nabla \cdot (\vec{a} \cdot \nabla) \end{aligned} \quad (2.6)$$

is a further generalization of the Laplacean operator Δ in the case where the medium is *anisotropic* and *inhomogeneous*. The coefficients a_1, a_2 depend on the space variable x and reflect the position as well as the directional dependence of the material properties, such as porosity in the case of fluid flow or dielectric constants in electrostatics. In fact, the above operator can be viewed as a particular case of $L = \nabla \cdot (A \nabla)$, where A is a 2×2 matrix which acts on the two components of ∇ .

2.1.2 THE CONVECTION DIFFUSION EQUATION

Many physical problems involve a combination of “diffusion” and “convection” phenomena. Such phenomena are modeled by the convection-diffusion equation

$$\frac{\partial u}{\partial t} + b_1 \frac{\partial u}{\partial x_1} + b_2 \frac{\partial u}{\partial x_2} = \nabla \cdot (a \nabla) u + f$$

or

$$\frac{\partial u}{\partial t} + \vec{b} \cdot \nabla u = \nabla \cdot (a \nabla) u + f$$

the steady-state version of which can be written as

$$-\nabla \cdot (a \nabla) u + \vec{b} \cdot \nabla u = f. \quad (2.7)$$

Problems of this type are often used as model problems because they represent the simplest form of conservation of mass in fluid mechanics. Note that the vector \vec{b} is sometimes quite large, which may cause some difficulties either to the discretization schemes or to the iterative solution techniques.

FINITE DIFFERENCE METHODS

2.2

The *finite difference* method is based on local approximations of the partial derivatives in a Partial Differential Equation, which are derived by low order Taylor series expansions. The method is quite simple to define and rather easy to implement. Also, it is particularly appealing for simple regions, such as rectangles, and when uniform meshes are used. The matrices that result from these discretizations are often well structured, which means that they typically consist of a few nonzero diagonals. Another advantage is that there are a number of “fast solvers” for constant coefficient problems, which can deliver the solution in logarithmic time per grid point. This means the total number of operations is of the order of $n \log(n)$ where n is the total number of discretization points. This section gives

an overview of finite difference discretization techniques.

2.2.1 BASIC APPROXIMATIONS

The simplest way to approximate the first derivative of a function u at the point x is via the formula

$$\left(\frac{du}{dx}\right)(x) \approx \frac{u(x+h) - u(x)}{h}. \quad (2.8)$$

When u is differentiable at x , then the limit of the above ratio when h tends to zero is the derivative of u at x . For a function that is C^4 in the neighborhood of x , we have by Taylor's formula

$$u(x+h) = u(x) + h \frac{du}{dx} + \frac{h^2}{2} \frac{d^2u}{dx^2} + \frac{h^3}{6} \frac{d^3u}{dx^3} + \frac{h^4}{24} \frac{d^4u}{dx^4}(\xi_+), \quad (2.9)$$

for some ξ_+ in the interval $(x, x+h)$. Therefore, the above approximation (2.8) satisfies

$$\frac{du}{dx} = \frac{u(x+h) - u(x)}{h} - \frac{h}{2} \frac{d^2u}{dx^2} + O(h^2). \quad (2.10)$$

The formula (2.9) can be rewritten with h replaced by $-h$ to obtain

$$u(x-h) = u(x) - h \frac{du}{dx} + \frac{h^2}{2} \frac{d^2u}{dx^2} - \frac{h^3}{6} \frac{d^3u}{dx^3} + \frac{h^4}{24} \frac{d^4u}{dx^4}(\xi_-), \quad (2.11)$$

in which ξ_- belongs to the interval $(x-h, x)$. Adding (2.9) and (2.11), dividing through by h^2 , and using the mean value theorem for the fourth order derivatives results in the following approximation of the second derivative

$$\frac{d^2u(x)}{dx^2} = \frac{u(x+h) - 2u(x) + u(x-h)}{h^2} - \frac{h^2}{12} \frac{d^4u(\xi)}{dx^4}, \quad (2.12)$$

where $\xi_- \leq \xi \leq \xi_+$. The above formula is called a *centered difference approximation* of the second derivative since the point at which the derivative is being approximated is the center of the points used for the approximation. The dependence of this derivative on the values of u at the points involved in the approximation is often represented by a “stencil” or “molecule,” shown in Figure 2.2.

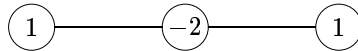

Figure 2.2 The three-point stencil for the centered difference approximation to the second order derivative.

The approximation (2.8) for the first derivative is *forward* rather than centered. Also, a *backward* formula can be used which consists of replacing h with $-h$ in (2.8). The two formulas can also be averaged to obtain the *centered difference* formula:

$$\frac{du(x)}{dx} \approx \frac{u(x+h) - u(x-h)}{2h}. \quad (2.13)$$

It is easy to show that the above centered difference formula is of the second order, while (2.8) is only first order accurate. Denoted by δ^+ and δ^- , the forward and backward difference operators are defined by

$$\delta^+ u(x) = u(x+h) - u(x) \quad (2.14)$$

$$\delta^- u(x) = u(x) - u(x-h). \quad (2.15)$$

All previous approximations can be rewritten using these operators.

In addition to standard first order and second order derivatives, it is sometimes necessary to approximate the second order operator

$$\frac{d}{dx} \left[a(x) \frac{d}{dx} \right].$$

A centered difference formula for this, which has second order accuracy, is given by

$$\begin{aligned} \frac{d}{dx} \left[a(x) \frac{du}{dx} \right] &= \frac{1}{h^2} \delta^+ (a_{i-1/2} \delta^- u) + O(h^2) \\ &\approx \frac{a_{i+1/2}(u_{i+1} - u_i) - a_{i-1/2}(u_i - u_{i-1})}{h^2}. \end{aligned} \quad (2.16)$$

2.2.2 DIFFERENCE SCHEMES FOR THE LAPLACEAN OPERATOR

If the approximation (2.12) is used for both the $\frac{\partial^2}{\partial x_1^2}$ and $\frac{\partial^2}{\partial x_2^2}$ terms in the Laplacean operator, using a mesh size of h_1 for the x_1 variable and h_2 for the x_2 variable, the following second order accurate approximation results:

$$\Delta u(x) \approx \frac{u(x_1+h_1, x_2) - 2u(x_1, x_2) + u(x_1-h_1, x_2)}{h_1^2} + \frac{u(x_1, x_2+h_2) - 2u(x_1, x_2) + u(x_1, x_2-h_2)}{h_2^2}.$$

In the particular case where the mesh sizes h_1 and h_2 are the same and equal to a mesh size h , the approximation becomes

$$\begin{aligned} \Delta u(x) &\approx \frac{1}{h^2} [u(x_1+h, x_2) + u(x_1-h, x_2) + u(x_1, x_2+h) \\ &\quad + u(x_1, x_2-h) - 4u(x_1, x_2)], \end{aligned} \quad (2.17)$$

which is called the five-point centered approximation to the Laplacean. The stencil of this finite difference approximation is illustrated in (a) of Figure 2.3.

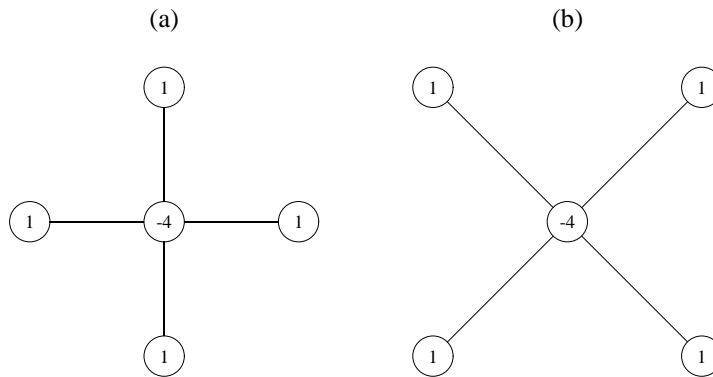

Figure 2.3 Five-point stencils for the centered difference approximation to the Laplacean operator: (a) the standard stencil, (b) the skewed stencil.

Another approximation may be obtained by exploiting the four points $u(x_1 \pm h, x_2 \pm h)$ located on the two diagonal lines from $u(x_1, x_2)$. These points can be used in the same manner as in the previous approximation except that the mesh size has changed. The corresponding stencil is illustrated in (b) of Figure 2.3.

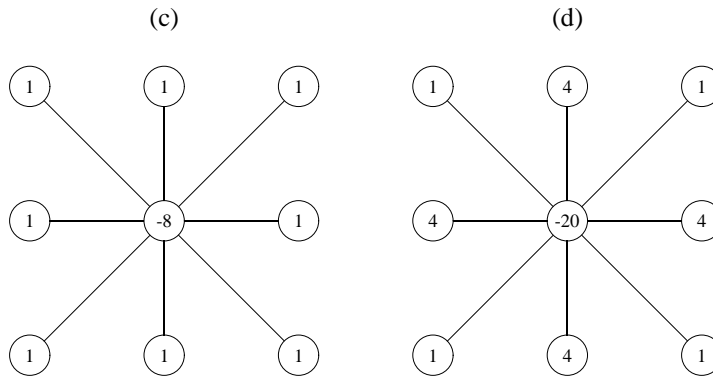

Figure 2.4 Two nine-point centered difference stencils for the Laplacean operator.

The approximation (2.17) is second order accurate and the error takes the form

$$\frac{h^2}{12} \left(\frac{\partial^4 u}{\partial^4 x_1} + \frac{\partial^4 u}{\partial^4 x_2} \right) + O(h^3).$$

There are other schemes that utilize nine-point formulas as opposed to five-point formulas. Two such schemes obtained by combining the standard and skewed stencils described above are shown in Figure 2.4. Both approximations (c) and (d) are second order accurate. However, (d) is sixth order for harmonic functions, i.e., functions whose Laplacean is zero.

2.2.3 FINITE DIFFERENCES FOR 1-D PROBLEMS

Consider the one-dimensional equation,

$$-u''(x) = f(x) \text{ for } x \in (0, 1) \quad (2.18)$$

$$u(0) = u(1) = 0. \quad (2.19)$$

The interval $[0,1]$ can be discretized uniformly by taking the $n + 2$ points

$$x_i = i \times h, \quad i = 0, \dots, n + 1$$

where $h = 1/(n + 1)$. Because of the Dirichlet boundary conditions, the values $u(x_0)$ and $u(x_{n+1})$ are known. At every other point, an approximation u_i is sought for the exact solution $u(x_i)$.

If the centered difference approximation (2.12) is used, then by the equation (2.18) expressed at the point x_i , the unknowns u_i, u_{i-1}, u_{i+1} satisfy the relation

$$-u_{i-1} + 2u_i - u_{i+1} = h^2 f_i,$$

in which $f_i \equiv f(x_i)$. Notice that for $i = 1$ and $i = n$, the equation will involve u_0 and u_{n+1} which are known quantities, both equal to zero in this case. Thus, for $n = 6$, the linear system obtained is of the form

$$Ax = f$$

where

$$A = \frac{1}{h^2} \begin{pmatrix} 2 & -1 & & & & & \\ -1 & 2 & -1 & & & & \\ & -1 & 2 & -1 & & & \\ & & -1 & 2 & -1 & & \\ & & & -1 & 2 & -1 & \\ & & & & -1 & 2 & \\ & & & & & -1 & 2 \end{pmatrix}.$$

2.2.4 UPWIND SCHEMES

Consider now the one-dimensional version of the convection-diffusion equation (2.7) in which the coefficients a and b are constant, and $f = 0$, using Dirichlet boundary conditions,

$$\begin{cases} -a u'' + b u' & = 0, & 0 < x < L = 1 \\ u(0) = 0, u(L) & = 1. \end{cases} \quad (2.20)$$

In this particular case, it is easy to verify that the exact solution to the above equation is given by

$$u(x) = \frac{1 - e^{Rx}}{1 - e^R}$$

where R is the so-called Péclet number defined by $R = bL/a$. Now consider the approximate solution provided by using the centered difference schemes seen above, for both the

first- and second order derivatives. The equation for unknown number i becomes

$$b \frac{u_{i+1} - u_{i-1}}{2h} - a \frac{u_{i+1} - 2u_i + u_{i-1}}{h^2} = 0,$$

or, defining $c = Rh/2$,

$$-(1 - c)u_{i+1} + 2u_i - (1 + c)u_{i-1} = 0. \quad (2.21)$$

This is a second order homogeneous linear difference equation and the usual way to solve it is to seek a general solution in the form $u_j = r^j$. Substituting in (2.21), r must satisfy

$$(1 - c)r^2 - 2r + (c + 1) = 0.$$

Therefore, $r_1 = 1$ is a root and the second root is $r_2 = (1 + c)/(1 - c)$. The general solution of the above difference equation is now sought as a linear combination of the two solutions corresponding to these two roots,

$$u_i = \alpha r_1^i + \beta r_2^i = \alpha + \beta \left(\frac{1 + c}{1 - c} \right)^i.$$

Because of the boundary condition $u_0 = 0$, it is necessary that $\beta = -\alpha$. Likewise, the boundary condition $u_{n+1} = 1$ yields

$$\alpha = \frac{1}{1 - \sigma^{n+1}} \quad \text{with} \quad \sigma \equiv \frac{1 + c}{1 - c}.$$

Thus, the solution is

$$u_i = \frac{1 - \sigma^i}{1 - \sigma^{n+1}}.$$

When $h > 2/R$ the factor σ becomes negative and the above approximations will oscillate around zero. In contrast, the exact solution is positive and monotone in the range $[0, 1]$. In this situation the solution is very inaccurate regardless of the arithmetic. In other words, the scheme itself creates the oscillations. To avoid this, a small enough mesh h can be taken to ensure that $c < 1$. The resulting approximation is in much better agreement with the exact solution. Unfortunately, this condition can limit the mesh size too drastically for large values of b .

Note that when $b < 0$, the oscillations disappear since $\sigma < 1$. In fact, a linear algebra interpretation of the oscillations comes from comparing the tridiagonal matrices obtained from the discretization. Again, for the case $n = 6$, the tridiagonal matrix resulting from discretizing the equation (2.7) takes the form

$$A = \frac{1}{h^2} \begin{pmatrix} 2 & -1 + c & & & & & \\ -1 - c & 2 & -1 + c & & & & \\ & -1 - c & 2 & -1 + c & & & \\ & & -1 - c & 2 & -1 + c & & \\ & & & -1 - c & 2 & -1 + c & \\ & & & & -1 - c & 2 & \\ & & & & & -1 - c & 2 \end{pmatrix}.$$

The above matrix is no longer a diagonally dominant M-matrix. Observe that if the backward difference formula for the first order derivative is used, we obtain

$$b \frac{u_i - u_{i-1}}{h} - a \frac{u_{i-1} - 2u_i + u_{i+1}}{h^2} = 0.$$

Then (weak) diagonal dominance is preserved if $b > 0$. This is because the new matrix obtained for the above backward scheme is

$$A = \frac{1}{h^2} \begin{pmatrix} 2+c & -1 & & & & & \\ -1-c & 2+c & -1 & & & & \\ & -1-c & 2+c & -1 & & & \\ & & -1-c & 2+c & -1 & & \\ & & & -1-c & 2+c & -1 & \\ & & & & -1-c & 2+c & -1 \\ & & & & & -1-c & 2+c \end{pmatrix}$$

where c is now defined by $c = Rh$. Each diagonal term a_{ii} gets reinforced by the positive term c while each subdiagonal term $a_{i,i-1}$ increases by the same amount in absolute value. In the case where $b < 0$, the forward difference formula

$$b \frac{u_{i+1} - u_i}{h} - a \frac{u_{i-1} - 2u_i + u_{i+1}}{h^2} = 0$$

can be used to achieve the same effect. Generally speaking, if b depends on the space variable x , the effect of weak-diagonal dominance can be achieved by simply adopting the following discretization known as an ‘‘upwind scheme’’:

$$b \frac{\delta_i^* u_i}{h} - a \frac{u_{i-1} - 2u_i + u_{i+1}}{h^2} = 0$$

where

$$\delta_i^* = \begin{cases} \delta_i^- & \text{if } b > 0 \\ \delta_i^+ & \text{if } b < 0. \end{cases}$$

The above difference scheme can be rewritten by introducing the sign function $\text{sign}(b) = |b|/b$. The approximation to u' at x_i is then defined by

$$u'(x_i) \approx \frac{1}{2}(1 - \text{sign}(b)) \frac{\delta^+ u_i}{h} + \frac{1}{2}(1 + \text{sign}(b)) \frac{\delta^- u_i}{h}.$$

Making use of the notation

$$(x)^+ = \frac{1}{2}(x + |x|), \quad (x)^- = \frac{1}{2}(x - |x|), \quad (2.22)$$

a slightly more elegant formula can be obtained by expressing the approximation of the product $b(x_i)u'(x_i)$,

$$\begin{aligned} b(x_i)u'(x_i) &\approx \frac{1}{2}(b_i - |b_i|) \frac{\delta^+ u_i}{h} + \frac{1}{2}(b_i + |b_i|) \frac{\delta^- u_i}{h} \\ &\approx \frac{1}{h} [-b_i^+ u_{i-1} + |b_i| u_i + b_i^- u_{i+1}], \end{aligned} \quad (2.23)$$

where b_i stands for $b(x_i)$. The diagonal term in the resulting tridiagonal matrix is nonnegative, the offdiagonal terms are nonpositive, and the diagonal term is the negative sum of the offdiagonal terms. This property characterizes upwind schemes.

A notable disadvantage of upwind schemes is the low order of approximation which they yield. An advantage is that upwind schemes yield linear systems that are easier to solve by iterative methods.

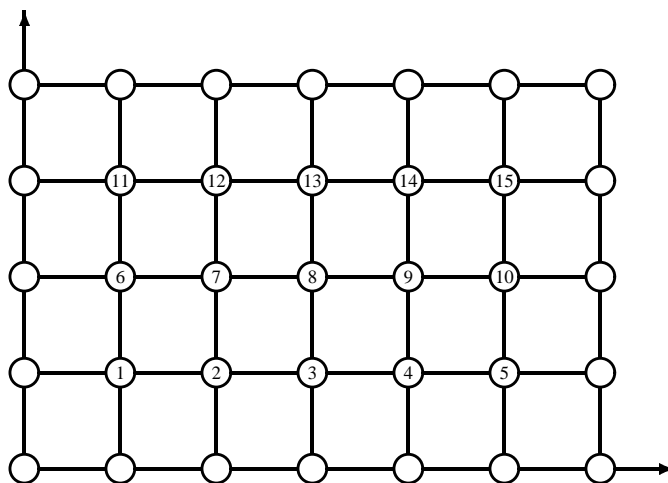

Figure 2.5 Natural ordering of the unknowns for a 7×5 two-dimensional grid.

2.2.5 FINITE DIFFERENCES FOR 2-D PROBLEMS

Similar to the previous case, consider this simple problem,

$$-\left(\frac{\partial^2 u}{\partial x_1^2} + \frac{\partial^2 u}{\partial x_2^2}\right) = f \quad \text{in } \Omega \quad (2.24)$$

$$u = 0 \quad \text{on } \Gamma \quad (2.25)$$

where Ω is now the rectangle $(0, l_1) \times (0, l_2)$ and Γ its boundary. Both intervals can be discretized uniformly by taking $n_1 + 2$ points in the x_1 direction and $n_2 + 2$ points in the x_2 directions:

$$x_{1,i} = i \times h_1, i = 0, \dots, n_1 + 1 \quad x_{2,j} = j \times h_2, j = 0, \dots, n_2 + 1$$

where

$$h_1 = \frac{l_1}{n_1 + 1} \quad h_2 = \frac{l_2}{n_2 + 1}.$$

Since the values at the boundaries are known, we number only the interior points, i.e., the points $(x_{1,i}, x_{2,j})$ with $0 < i < n_1$ and $0 < j < n_2$. The points are labeled from the bottom up, one horizontal line at a time. This labeling is called *natural ordering* and is shown in Figure 2.5 for the very simple case when $n_1 = 7$ and $n_2 = 5$. The pattern of the matrix corresponding to the above equations appears in Figure 2.6.

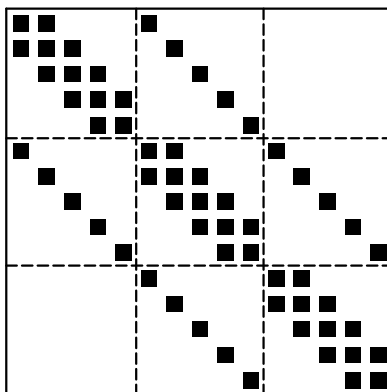

Figure 2.6 Pattern of matrix associated with the 7×5 finite difference mesh of Figure 2.5.

To be more accurate, the matrix has the following block structure:

$$A = \frac{1}{h^2} \begin{pmatrix} B & -I & & & \\ -I & B & -I & & \\ & -I & B & -I & \\ & & -I & B & -I \\ & & & -I & B \end{pmatrix} \quad \text{with} \quad B = \begin{pmatrix} 4 & -1 & & & \\ -1 & 4 & -1 & & \\ & -1 & 4 & -1 & \\ & & -1 & 4 & -1 \\ & & & -1 & 4 \end{pmatrix}.$$

THE FINITE ELEMENT METHOD

2.3

The finite element method is best illustrated with the solution of a simple elliptic Partial Differential Equation in a two-dimensional space. Consider again Poisson's equation (2.24) with the Dirichlet boundary condition (2.25), where Ω is a bounded open domain in \mathbb{R}^2 and Γ its boundary. The Laplacean operator

$$\Delta = \frac{\partial^2}{\partial x_1^2} + \frac{\partial^2}{\partial x_2^2}$$

appears in many models of physical and mechanical phenomena. Equations involving the more general elliptic operators (2.5) and (2.6) can be treated in the same way as Poisson's equation (2.24) and (2.25), at least from the viewpoint of the numerical solutions techniques.

An essential ingredient for understanding the finite element method is *Green's formula*. The setting for this formula is an open set Ω whose boundary consists of a closed and smooth curve Γ as illustrated in Figure 2.1. A vector-valued function $\vec{v} = \begin{pmatrix} v_1 \\ v_2 \end{pmatrix}$, which is continuously differentiable in Ω , is given. The *divergence theorem* in two-dimensional spaces states that

$$\int_{\Omega} \operatorname{div} \vec{v} \, dx = \int_{\Gamma} \vec{v} \cdot \vec{n} \, ds. \quad (2.26)$$

The dot in the right-hand side represents a dot product of two vectors in \mathbb{R}^2 . In this case it is between the vector \vec{v} and the unit vector \vec{n} which is normal to Γ at the point of consideration and oriented outward. To derive Green's formula, consider a scalar function v and a vector function $\vec{w} = \begin{pmatrix} w_1 \\ w_2 \end{pmatrix}$. By standard differentiation,

$$\nabla \cdot (v\vec{w}) = (\nabla v) \cdot \vec{w} + v \nabla \cdot \vec{w},$$

which expresses $\nabla v \cdot \vec{w}$ as

$$\nabla v \cdot \vec{w} = -v \nabla \cdot \vec{w} + \nabla \cdot (v\vec{w}). \quad (2.27)$$

Integrating the above equality over Ω and using the divergence theorem, we obtain

$$\begin{aligned} \int_{\Omega} \nabla v \cdot \vec{w} \, dx &= - \int_{\Omega} v \nabla \cdot \vec{w} \, dx + \int_{\Omega} \nabla \cdot (v\vec{w}) \, dx \\ &= - \int_{\Omega} v \nabla \cdot \vec{w} \, dx + \int_{\Gamma} v\vec{w} \cdot \vec{n} \, ds. \end{aligned} \quad (2.28)$$

The above equality can be viewed as a generalization of the standard integration by part formula in calculus. Green's formula results from (2.28) by simply taking a vector \vec{w} which is itself a gradient of a scalar function u , namely, $\vec{w} = \nabla u$,

$$\int_{\Omega} \nabla v \cdot \nabla u \, dx = - \int_{\Omega} v \nabla \cdot \nabla u \, dx + \int_{\Gamma} v \nabla u \cdot \vec{n} \, ds.$$

Observe that $\nabla \cdot \nabla u = \Delta u$. Also the function $\nabla u \cdot \vec{n}$ is called the *normal derivative* and is denoted by

$$\nabla u \cdot \vec{n} = \frac{\partial u}{\partial \vec{n}}.$$

With this, we obtain Green's formula

$$\int_{\Omega} \nabla v \cdot \nabla u \, dx = - \int_{\Omega} v \Delta u \, dx + \int_{\Gamma} v \frac{\partial u}{\partial \vec{n}} \, ds. \quad (2.29)$$

We now return to the initial problem (2.24-2.25). To solve this problem approximately, it is necessary to (1) take approximations to the unknown function u , and (2) translate the equations into a system which can be solved numerically. The options for approximating u are numerous. However, the primary requirement is that these approximations should be in a (small) finite dimensional space. There are also some additional desirable numerical properties. For example, it is difficult to approximate high degree polynomials numerically. To extract systems of equations which yield the solution, it is common to use the *weak formulation* of the problem. Let us define

$$\begin{aligned} a(u, v) &\equiv \int_{\Omega} \nabla u \cdot \nabla v \, dx = \int_{\Omega} \left(\frac{\partial u}{\partial x_1} \frac{\partial v}{\partial x_1} + \frac{\partial u}{\partial x_2} \frac{\partial v}{\partial x_2} \right) dx, \\ (f, v) &\equiv \int_{\Omega} f v \, dx. \end{aligned}$$

An immediate property of the functional a is that it is *bilinear*. That means that it is linear with respect to u and v , namely,

$$\begin{aligned} a(\mu_1 u_1 + \mu_2 u_2, v) &= \mu_1 a(u_1, v) + \mu_2 a(u_2, v), \quad \forall \mu_1, \mu_2 \in \mathbb{R}, \\ a(u, \lambda_1 v_1 + \lambda_2 v_2) &= \lambda_1 a(u, v_1) + \lambda_2 a(u, v_2), \quad \forall \lambda_1, \lambda_2 \in \mathbb{R}. \end{aligned}$$

Notice that (u, v) denotes the L_2 -inner product of u and v in Ω , i.e.,

$$(u, v) = \int_{\Omega} u(x)v(x)dx,$$

then, for functions satisfying the Dirichlet boundary conditions, which are at least twice differentiable, Green's formula (2.29) shows that

$$a(u, v) = -(\Delta u, v).$$

The weak formulation of the initial problem (2.24-2.25) consists of selecting a subspace of reference V of L^2 and then defining the following problem:

$$\text{Find } u \in V \text{ such that } a(u, v) = (f, v), \quad \forall v \in V. \quad (2.30)$$

In order to understand the usual choices for the space V , note that the definition of the weak problem only requires the dot products of the gradients of u and v and the functions f and v to be L_2 -integrable. The most general V under these conditions is the space of all functions whose derivatives up to the first order are in L_2 . This is known as $H^1(\Omega)$. However, this space does not take into account the boundary conditions. The functions in V must be restricted to have zero values on Γ . The resulting space is called $H_0^1(\Omega)$.

The finite element method consists of approximating the weak problem by a finite-dimensional problem obtained by replacing V with a subspace of functions that are defined as low-degree polynomials on small pieces (elements) of the original domain.

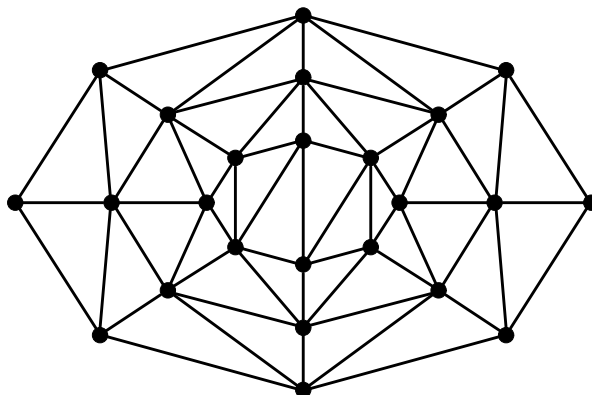

Figure 2.7 *Finite element triangulation of a domain.*

Consider a region Ω in the plane which is triangulated as shown in Figure 2.7. In this example, the domain is simply an ellipse but the external enclosing curve is not shown. The original domain is thus approximated by the union Ω_h of m triangles K_i ,

$$\Omega_h = \bigcup_{i=1}^m K_i.$$

For the triangulation to be valid, these triangles must have no vertex that lies on the edge

of any other triangle. The *mesh size* h is defined by

$$h = \max_{i=1, \dots, m} \text{diam}(K_i)$$

where $\text{diam}(K)$, the diameter of a triangle K , is the length of its longest side.

Then the finite dimensional space V_h is defined as the space of all functions which are piecewise linear and continuous on the polygonal region Ω_h , and which vanish on the boundary Γ . More specifically,

$$V_h = \{\phi \mid \phi|_{\Omega_h} \text{ continuous}, \phi|_{\Gamma_h} = 0, \phi|_{K_j} \text{ linear } \forall j\}.$$

Here, $\phi|_X$ represents the restriction of the function ϕ to the subset X . If $x_j, j = 1, \dots, n$ are the nodes of the triangulation, then a function ϕ_j in V_h can be associated with each node x_j , so that the family of functions ϕ_j 's satisfies the following conditions:

$$\phi_j(x_i) = \delta_{ij} = \begin{cases} 1 & \text{if } x_i = x_j \\ 0 & \text{if } x_i \neq x_j \end{cases}. \quad (2.31)$$

These conditions define $\phi_i, i = 1, \dots, n$ uniquely. In addition, the ϕ_i 's form a basis of the space V_h .

Each function of V_h can be expressed as

$$\phi(x) = \sum_{i=1}^n \xi_i \phi_i(x).$$

The finite element approximation consists of writing the Galerkin condition (2.30) for functions in V_h . This defines the approximate problem:

$$\text{Find } u \in V_h \text{ such that } a(u, v) = (f, v), \quad \forall v \in V_h. \quad (2.32)$$

Since u is in V_h , there are n degrees of freedom. By the linearity of a with respect to v , it is only necessary to impose the condition $a(u, \phi_i) = (f, \phi_i)$ for $i = 1, \dots, n$. This results in n constraints.

Writing the desired solution u in the basis $\{\phi_i\}$ as

$$u = \sum_{i=1}^n \xi_i \phi_i(x)$$

and substituting in (2.32) gives the linear problem

$$\sum_{j=1}^n \alpha_{ij} \xi_j = \beta_i \quad (2.33)$$

where

$$\alpha_{ij} = a(\phi_i, \phi_j), \quad \beta_i = (f, \phi_i).$$

The above equations form a linear system of equations

$$Ax = b,$$

in which the coefficients of A are the α_{ij} 's; those of b are the β_j 's. In addition, A is a *Symmetric Positive Definite* matrix. Indeed, it is clear that

$$\int_{\Omega} \nabla \phi_i \nabla \phi_j \, dx = \int_{\Omega} \nabla \phi_j \nabla \phi_i \, dx,$$

which means that $\alpha_{ij} = \alpha_{ji}$. To see that A is positive definite, first note that $a(u, u) \geq 0$ for any function u . If $a(\phi, \phi) = 0$ for a function in V_h , then it must be true that $\nabla \phi = 0$ *almost everywhere* in Ω_h . Since ϕ is linear in each triangle and continuous, then it is clear that it must be constant on all Ω . Since, in addition, it vanishes on the boundary, then it must be equal to zero on all of Ω . The result follows by exploiting the relation

$$(A\xi, \xi) = a(\phi, \phi) \quad \text{with} \quad \phi = \sum_{i=1}^n \xi_i \phi_i,$$

which is valid for any vector $\{\xi_i\}_{i=1, \dots, n}$.

Another important observation is that the matrix A is also sparse. Indeed, α_{ij} is nonzero only when the two basis functions ϕ_i and ϕ_j have common support triangles, or equivalently when the nodes i and j are the vertices of a common triangle. Specifically, for a given node i , the coefficient α_{ij} will be nonzero only when the node j is one of the nodes of a triangle that is adjacent to node i .

In practice, the matrix is built by summing up the contributions of all triangles by applying the formula

$$a(\phi_i, \phi_j) = \sum_K a_K(\phi_i, \phi_j)$$

in which the sum is over all the triangles K and

$$a_K(\phi_i, \phi_j) = \int_K \nabla \phi_i \nabla \phi_j \, dx.$$

Note that $a_K(\phi_i, \phi_j)$ is zero unless the nodes i and j are both vertices of K . Thus, a triangle contributes nonzero values to its three vertices from the above formula. The 3×3 matrix

$$A_K = \begin{pmatrix} a_K(\phi_i, \phi_i) & a_K(\phi_i, \phi_j) & a_K(\phi_i, \phi_k) \\ a_K(\phi_j, \phi_i) & a_K(\phi_j, \phi_j) & a_K(\phi_j, \phi_k) \\ a_K(\phi_k, \phi_i) & a_K(\phi_k, \phi_j) & a_K(\phi_k, \phi_k) \end{pmatrix}$$

associated with the triangle $K(i, j, k)$ with vertices i, j, k is called an *element stiffness matrix*. In order to form the matrix A , it is necessary to sum up all the contributions $a_K(\phi_k, \phi_m)$ to the position k, m of the matrix. This process is called an *assembly* process. In the assembly, the matrix is computed as

$$A = \sum_{e=1}^{nel} A^{[e]}, \quad (2.34)$$

in which nel is the number of elements. Each of the matrices $A^{[e]}$ is of the form

$$A^{[e]} = P_e A_{K_e} P_e^T$$

where A_{K_e} is the element matrix for the element K_e as defined above. Also P_e is an $n \times 3$ Boolean connectivity matrix which maps the coordinates of the 3×3 matrix A_{K_e} into the coordinates of the full matrix A .

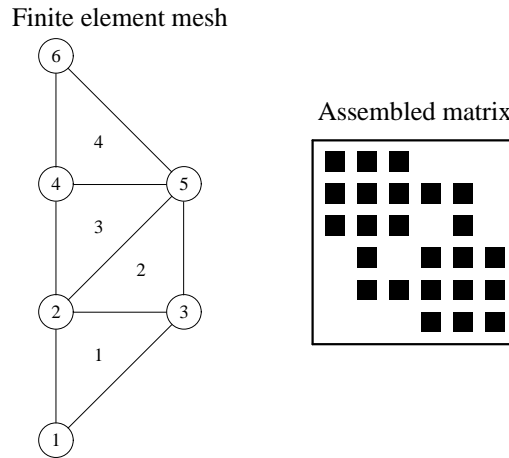

Figure 2.8 A simple finite element mesh and the pattern of the corresponding assembled matrix.

Example 2.1 The assembly process can be illustrated with a very simple example. Consider the finite element mesh shown in Figure 2.8. The four elements are numbered from bottom to top as indicated by the labels located at their centers. There are six nodes in this mesh and their labeling is indicated in the circled numbers. The four matrices $A^{[e]}$ associated with these elements are shown in Figure 2.9. Thus, the first element will contribute to the nodes 1, 2, 3, the second to nodes 2, 3, 5, the third to nodes 2, 4, 5, and the fourth to nodes 4, 5, 6.

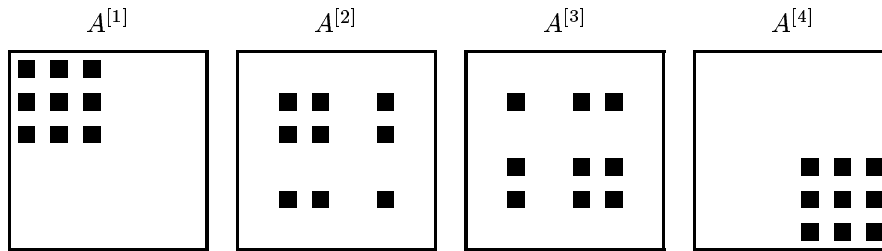

Figure 2.9 The element matrices $A^{[e]}$, $e = 1, \dots, 4$ for the finite element mesh shown in Figure 2.8.

In fact there are two different ways to represent and use the matrix A . We can form all the element matrices one by one and then we can store them, e.g., in an $nel \times 3 \times 3$ rectangular array. This representation is often called the *unassembled form* of A . Then the matrix A may be assembled if it is needed. However, element stiffness matrices can also be used in different ways without having to assemble the matrix. For example, *frontal techniques* are direct solution methods that take the linear system in unassembled form and compute the solution by a form of Gaussian elimination. There are also iterative solution techniques which work directly with unassembled matrices. One of the main operations

required in many iterative methods is to compute $y = Ax$, the product of the matrix A by an arbitrary vector x . In unassembled form, this can be achieved as follows:

$$y = Ax = \sum_{e=1}^{nel} A^{[e]} x = \sum_{e=1}^{nel} P_e A_{K_e} (P_e^T x). \quad (2.35)$$

Thus, the product $P_e^T x$ gathers the x data associated with the e -element into a 3-vector consistent with the ordering of the matrix A_{K_e} . After this is done, this vector must be multiplied by A_{K_e} . Finally, the result is added to the current y vector in appropriate locations determined by the P_e array. This sequence of operations must be done for each of the nel elements.

A more common and somewhat more appealing technique is to perform the assembly of the matrix. All the elements are scanned one by one and the nine associated contributions $a_K(\phi_k, \phi_m)$, $k, m \in \{i, j, k\}$ added to the corresponding positions in the global “stiffness” matrix. The assembled matrix must now be stored but the element matrices may be discarded. The structure of the assembled matrix depends on the ordering of the nodes. To facilitate the computations, a widely used strategy transforms all triangles into a reference triangle with vertices $(0, 0)$, $(0, 1)$, $(1, 0)$. The area of the triangle is then simply the determinant of the Jacobian of the transformation that allows passage from one set of axes to the other.

Simple boundary conditions such as Neumann or Dirichlet do not cause any difficulty. The simplest way to handle Dirichlet conditions is to include boundary values as unknowns and modify the assembled system to incorporate the boundary values. Thus, each equation associated with the boundary point in the assembled system is replaced by the equation $u_i = f_i$. This yields a small identity block hidden within the linear system. For Neumann conditions, Green’s formula will give rise to the equations

$$\int_{\Omega} \nabla u \cdot \nabla \phi_j \, dx = \int_{\Omega} f \phi_j \, dx + \int_{\Gamma} \phi_j \frac{\partial u}{\partial \bar{n}} \, ds, \quad (2.36)$$

which will involve the Neumann data $\frac{\partial u}{\partial \bar{n}}$ over the boundary. Since the Neumann data is typically given at some points only (the boundary nodes), linear interpolation (trapezoidal rule) or the mid-line value (midpoint rule) can be used to approximate the integral. Note that (2.36) can be viewed as the j -th equation of the linear system. Another important point is that if the boundary conditions are only of Neumann type, then the resulting system is singular. An equation must be removed, or the linear system must be solved by taking this singularity into account.

MESH GENERATION AND REFINEMENT

2.4

Generating a finite element triangulation can be done quite easily by exploiting some initial grid and then refining the mesh a few times either uniformly or in specific areas. The simplest refinement technique consists of taking the three midpoints of a triangle, thus creating four smaller triangles from a larger triangle and losing one triangle, namely, the

original one. A systematic use of one level of this strategy is illustrated for the mesh in Figure 2.8, and is shown in Figure 2.10.

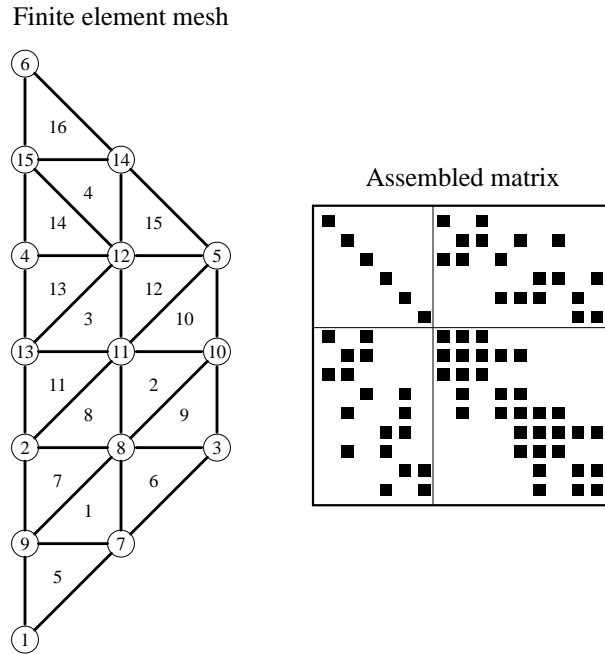

Figure 2.10 *The simple finite element mesh of Figure 2.8 after one level of refinement and the corresponding matrix.*

One advantage of this approach is that it preserves the angles of the original triangulation. This is an important property since the angles on a good quality triangulation must satisfy certain bounds. On the other hand, the indiscriminate use of the uniform refinement strategy may lead to some inefficiencies. Indeed, it is desirable to introduce more triangles in areas where the solution is likely to have large variations. In terms of vertices, midpoints should be introduced only where needed. To obtain standard finite element triangles, the points that have been created on the edges of a triangle must be linked to existing vertices in the triangle. This is because no vertex of a triangle is allowed to lie on the edge of another triangle.

Figure 2.11 shows three possible cases that can arise. The original triangle is (a). In (b), only one new vertex (numbered 4) has appeared on one edge of the triangle and it is joined to the vertex opposite to it. In (c), two new vertices appear inside the original triangle. There is no alternative but to join vertices (4) and (5). However, after this is done, either vertices (4) and (3) or vertices (1) and (5) must be joined. If angles are desired that will not become too small with further refinements, the second choice is clearly better in this case. In fact, various strategies for improving the quality of the triangles have been devised. The final case (d) corresponds to the “uniform refinement” case where all edges have been split in two. There are three new vertices and four new elements, and the larger initial element is removed.

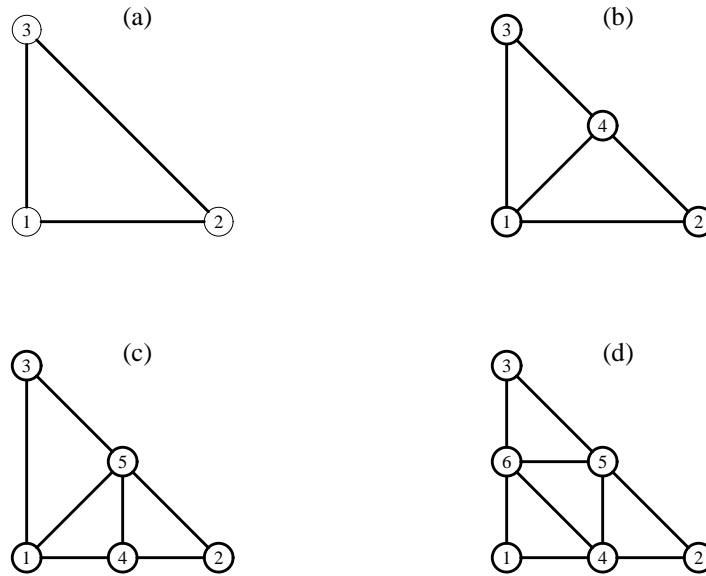

Figure 2.11 Original triangle (a) and three possible refinement scenarios.

FINITE VOLUME METHOD

2.5

The finite volume method is geared toward the solution of conservation laws of the form:

$$\frac{\partial u}{\partial t} + \nabla \cdot \vec{F} = Q. \quad (2.37)$$

In the above equation, $\vec{F}(u, t)$ is a certain vector function of u and time, possibly nonlinear. This is called the “flux vector.” The *source term* Q is a function of space and time. We now apply the principle used in the weak formulation, described before. Multiply both sides by a test function w , and take the integral

$$\int_{\Omega} w \frac{\partial u}{\partial t} dx + \int_{\Omega} w \nabla \cdot \vec{F} dx = \int_{\Omega} w Q dx.$$

Then integrate by part using formula (2.28) for the second term on the left-hand side to obtain

$$\int_{\Omega} w \frac{\partial u}{\partial t} dx - \int_{\Omega} \nabla w \cdot \vec{F} dx + \int_{\Gamma} w \vec{F} \cdot \vec{n} ds = \int_{\Omega} w Q dx.$$

Consider now a *control volume* consisting, for example, of an elementary triangle K_i in the two-dimensional case, such as those used in the finite element method. Take for w a function w_i whose value is one on the triangle and zero elsewhere. The second term in the

above equation vanishes and the following relation results:

$$\int_{K_i} \frac{\partial u}{\partial t} dx + \int_{\Gamma_i} \vec{F} \cdot \vec{n} ds = \int_{K_i} Q dx. \quad (2.38)$$

The above relation is at the basis of the finite volume approximation. To go a little further, the assumptions will be simplified slightly by taking a vector function \vec{F} that is linear with respect to u . Specifically, assume

$$\vec{F} = \begin{pmatrix} \lambda_1 u \\ \lambda_2 u \end{pmatrix} \equiv \vec{\lambda} u.$$

Note that, in this case, the term $\nabla \cdot \vec{F}$ in (2.37) becomes $\vec{F}'(u) = \vec{\lambda} \cdot \nabla u$. In addition, the right-hand side and the first term in the left-hand side of (2.38) can be approximated as follows:

$$\int_{K_i} \frac{\partial u}{\partial t} dx \approx \frac{\partial u_i}{\partial t} |K_i|, \quad \int_{K_i} Q dx \approx q_i |K_i|.$$

Here, $|K_i|$ represents the volume¹ of K_i , and q_i is some average value of Q in the cell K_i . These are crude approximations but they serve the purpose of illustrating the scheme.

The finite volume equation (2.38) yields

$$\frac{\partial u_i}{\partial t} |K_i| + \vec{\lambda} \cdot \int_{\Gamma_i} u \vec{n} ds = q_i |K_i|. \quad (2.39)$$

The contour integral

$$\int_{\Gamma_i} u \vec{n} ds$$

is the sum of the integrals over all edges of the control volume. Let the value of u on each edge j be approximated by some “average” \bar{u}_j . In addition, s_j denotes the length of each edge and a common notation is

$$\vec{s}_j = s_j \vec{n}_j.$$

Then the contour integral is approximated by

$$\vec{\lambda} \cdot \int_{\Gamma_i} u \vec{n} ds \approx \sum_{edges} \bar{u}_j \vec{\lambda} \cdot \vec{n}_j s_j = \sum_{edges} \bar{u}_j \vec{\lambda} \cdot \vec{s}_j. \quad (2.40)$$

The situation in the case where the control volume is a simple triangle is depicted in Figure 2.12. The unknowns are the approximations u_i of the function u associated with each cell. These can be viewed as approximations of u at the centers of gravity of each cell i . This type of model is called *cell-centered* finite volume approximations. Other techniques based on using approximations on the vertices of the cells are known as *cell-vertex* finite volume techniques.

¹In two dimensions, “volume” is considered to mean area.

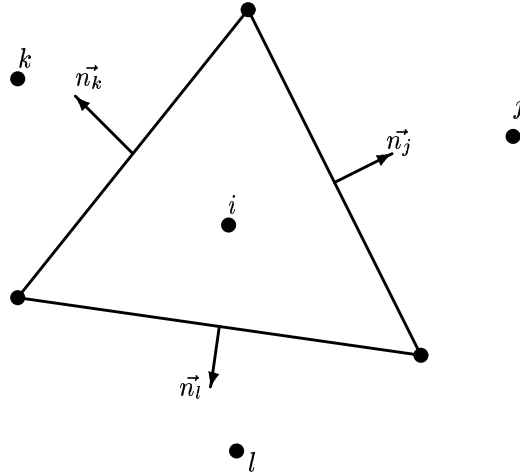

Figure 2.12 Finite volume cell associated with node i and three neighboring cells.

The value \bar{u}_j required in (2.40) can be taken simply as the average between the approximation u_i of u in cell i and the approximation u_j in the cell j on the other side of the edge

$$\bar{u}_j = \frac{1}{2}(u_j + u_i). \quad (2.41)$$

This gives

$$\frac{\partial u_i}{\partial t} |K_i| + \frac{1}{2} \sum_j (u_i + u_j) \vec{\lambda} \cdot \vec{s}_j = q_i |K_i|.$$

One further simplification takes place by observing that

$$\sum_j \vec{s}_j = 0$$

and therefore

$$\sum_j u_i \vec{\lambda} \cdot \vec{s}_j = u_i \vec{\lambda} \cdot \sum_j \vec{s}_j = 0.$$

This yields

$$\frac{\partial u_i}{\partial t} |K_i| + \frac{1}{2} \sum_j u_j \vec{\lambda} \cdot \vec{s}_j = q_i |K_i|.$$

In the above equation, the summation is over all the neighboring cells j . One problem with such simple approximations is that they do not account for large gradients of u in the components. In finite volume approximations, it is typical to exploit upwind schemes which are more suitable in such cases. By comparing with one-dimensional up-

wind schemes, it can be easily seen that the suitable modification to (2.41) is as follows:

$$\bar{u}_j = \frac{1}{2}(u_j + u_i) - \frac{1}{2} \operatorname{sign}(\vec{\lambda} \cdot \vec{s}_j)(u_j - u_i). \quad (2.42)$$

This gives

$$\frac{\partial u_i}{\partial t} |K_i| + \sum_j \vec{\lambda} \cdot \vec{s}_j \left(\frac{1}{2}(u_j + u_i) - \frac{1}{2} \operatorname{sign}(\vec{\lambda} \cdot \vec{s}_j)(u_j - u_i) \right) = q_i |K_i|.$$

Now write

$$\begin{aligned} \frac{\partial u_i}{\partial t} |K_i| + \sum_j \left(\frac{1}{2}(u_j + u_i) \vec{\lambda} \cdot \vec{s}_j - \frac{1}{2} |\vec{\lambda} \cdot \vec{s}_j| (u_j - u_i) \right) &= q_i |K_i| \\ \frac{\partial u_i}{\partial t} |K_i| + \sum_j \left(u_i (\vec{\lambda} \cdot \vec{s}_j)^+ + u_j (\vec{\lambda} \cdot \vec{s}_j)^- \right) &= q_i |K_i| \end{aligned}$$

where

$$(z)^\pm \equiv \frac{z \pm |z|}{2}.$$

The equation for cell i takes the form

$$\frac{\partial u_i}{\partial t} |K_i| + \beta_i u_i + \sum_j \alpha_{ij} u_j = q_i |K_i|,$$

where

$$\beta_i = \sum_j (\vec{\lambda} \cdot \vec{s}_j)^+ \geq 0, \quad (2.43)$$

$$\alpha_{ij} = (\vec{\lambda} \cdot \vec{s}_j)^- \leq 0. \quad (2.44)$$

Thus, the diagonal elements of the matrix are nonnegative, while its offdiagonal elements are nonpositive. In addition, the row-sum of the elements, i.e., the sum of all elements in the same row, is equal to zero. This is because

$$\beta_i + \sum_j \alpha_{ij} = \sum_j (\vec{\lambda} \cdot \vec{s}_j)^+ + \sum_j (\vec{\lambda} \cdot \vec{s}_j)^- = \sum_j \vec{\lambda} \cdot \vec{s}_j = \vec{\lambda} \cdot \sum_j \vec{s}_j = 0.$$

The matrices obtained have the same desirable property of weak diagonal dominance seen in the one-dimensional case. A disadvantage of upwind schemes, whether in the context of irregular grids or in one-dimensional equations, is the loss of accuracy due to the low order of the schemes.

EXERCISES

1. Derive Forward Difference formulas similar to (2.8), i.e., involving $u(x)$, $u(x+h)$, $u(x+2h)$, \dots , which are of second and third order. Write down the discretization errors explicitly.

2. Derive a Centered Difference formula for the first derivative, similar to (2.13), which is at least of third order.
3. Show that the Upwind Difference scheme described in 2.2.4, when a and \vec{b} are constant, is stable for the model problem (2.7).
4. Develop the two nine-point formulas illustrated in Figure 2.4. Find the corresponding discretization errors. [Hint: Combine $\frac{1}{3}$ of the five-point formula (2.17) plus $\frac{2}{3}$ of the same formula based on the diagonal stencil $\{(x, y), (x+h, y+h), (x+h, y-h), (x-h, y+h), (x-h, y-h)\}$ to get one formula. Use the reverse combination $\frac{2}{3}, \frac{1}{3}$ to get the other formula.]
5. Consider a (two-dimensional) rectangular mesh which is discretized as in the finite difference approximation. Show that the finite volume approximation to $\vec{\lambda} \cdot \nabla u$ yields the same matrix as an upwind scheme applied to the same problem. What would be the mesh of the equivalent upwind finite difference approximation?
6. Show that the right-hand side of equation (2.16) can also be written as

$$\frac{1}{h^2} \delta^- \left(a_{i+\frac{1}{2}} \delta^+ u \right).$$

7. Show that the formula (2.16) is indeed second order accurate for functions that are in C^4 .
8. Show that the functions ϕ_i 's defined by (2.31) form a basis of V_h .
9. Develop the equivalent of Green's formula for the elliptic operator L defined in (2.6).
10. Write a short FORTRAN or C program to perform a matrix-by-vector product when the matrix is stored in unassembled form.
11. Consider the finite element mesh of Example 2.1. Compare the number of operations required to perform a matrix-by-vector product when the matrix is in assembled and in unassembled form. Compare also the storage required in each case. For a general finite element matrix, what can the ratio be between the two in the worst case (consider only linear approximations on triangular elements) for arithmetic? Express the number of operations in terms of the number of nodes and edges of the mesh. You may make the assumption that the maximum number of elements that are adjacent to a given node is p (e.g., $p = 8$).
12. Let K be a polygon in \mathbb{R}^2 with m edges, and let $\vec{s}_j = s_j \vec{n}_j$, for $j = 1, \dots, m$, where s_j is the length of the j -th edge and \vec{n}_j is the unit outward normal at the j -th edge. Use the divergence theorem to prove that $\sum_{j=1}^m \vec{s}_j = 0$.

NOTES AND REFERENCES. The material in this chapter is based on several sources. For a basic description of the finite element method, the book by C. Johnson is a good reference [128]. Axelsson and Barker [16] gives a treatment which includes various solution techniques emphasizing iterative techniques. For finite difference and finite volume methods, we recommend C. Hirsch [121], which also gives a good description of the equations and solution methods for fluid flow problems. ■

SPARSE MATRICES

As described in the previous chapter, standard discretizations of Partial Differential Equations typically lead to large and *sparse* matrices. A sparse matrix is defined, somewhat vaguely, as a matrix which has very few nonzero elements. But, in fact, a matrix can be termed sparse whenever special techniques can be utilized to take advantage of the large number of zero elements and their locations. These sparse matrix techniques begin with the idea that the zero elements need not be stored. One of the key issues is to define data structures for these matrices that are well suited for efficient implementation of standard solution methods, whether direct or iterative. This chapter gives an overview of sparse matrices, their properties, their representations, and the data structures used to store them.

INTRODUCTION

3.1

The natural idea to take advantage of the zeros of a matrix and their location was initiated by engineers in various disciplines. In the simplest case involving banded matrices, special techniques are straightforward to develop. Electrical engineers dealing with electrical networks in the 1960s were the first to exploit sparsity to solve general sparse linear systems for matrices with irregular structure. The main issue, and the first addressed by sparse matrix technology, was to devise direct solution methods for linear systems. These had to be economical, both in terms of storage and computational effort. Sparse direct solvers can handle very large problems that cannot be tackled by the usual “dense” solvers.

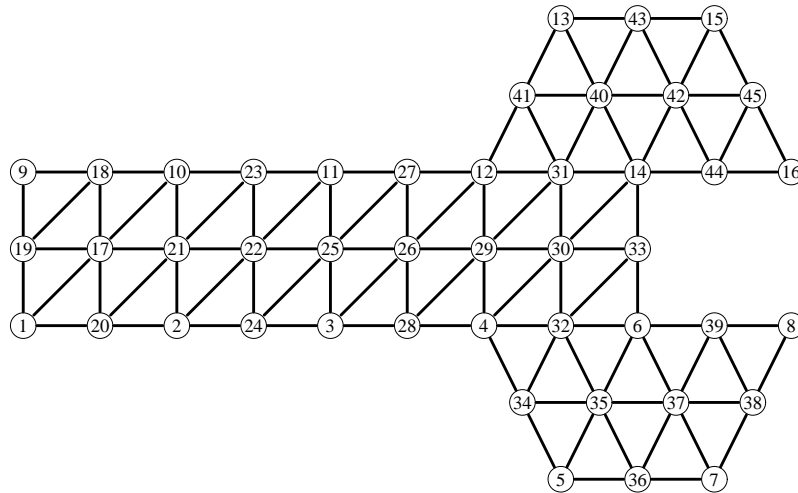

Figure 3.1 A finite element grid model.

Essentially, there are two broad types of sparse matrices: *structured* and *unstructured*. A structured matrix is one whose nonzero entries form a regular pattern, often along a small number of diagonals. Alternatively, the nonzero elements may lie in blocks (dense submatrices) of the same size, which form a regular pattern, typically along a small number of (block) diagonals. A matrix with irregularly located entries is said to be irregularly structured. The best example of a regularly structured matrix is a matrix that consists of only a few diagonals. Finite difference matrices on rectangular grids, such as the ones seen in the previous chapter, are typical examples of matrices with regular structure. Most finite element or finite volume techniques applied to complex geometries lead to irregularly structured matrices. Figure 3.2 shows a small irregularly structured sparse matrix associated with the finite element grid problem shown in Figure 3.1.

The distinction between the two types of matrices may not noticeably affect direct solution techniques, and it has not received much attention in the past. However, this distinction can be important for iterative solution methods. In these methods, one of the essential operations is matrix-by-vector products. The performance of these operations can differ significantly on high performance computers, depending on whether they are regularly structured or not. For example, on vector computers, storing the matrix by diagonals is ideal, but the more general schemes may suffer because they require indirect addressing.

The next section discusses graph representations of sparse matrices. This is followed by an overview of some of the storage schemes used for sparse matrices and an explanation of how some of the simplest operations with sparse matrices can be performed. Then sparse linear system solution methods will be covered. Finally, Section 3.7 discusses test matrices.

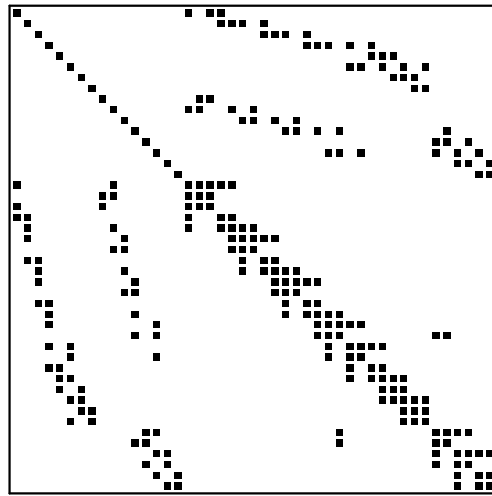

Figure 3.2 Sparse matrix associated with the finite element grid of Figure 3.1.

GRAPH REPRESENTATIONS

3.2

Graph theory is an ideal tool for representing the structure of sparse matrices and for this reason it plays a major role in sparse matrix techniques. For example, graph theory is the key ingredient used in unraveling parallelism in sparse Gaussian elimination or in preconditioning techniques. In the following section, graphs are discussed in general terms and then their applications to finite element or finite difference matrices are discussed.

3.2.1 GRAPHS AND ADJACENCY GRAPHS

Remember that a graph is defined by two sets, a set of vertices

$$V = \{v_1, v_2, \dots, v_n\},$$

and a set of edges E which consists of pairs (v_i, v_j) , where v_i, v_j are elements of V , i.e.,

$$E \subseteq V \times V.$$

This graph $G = (V, E)$ is often represented by a set of points in the plane linked by a directed line between the points that are connected by an edge. A graph is a way of representing a binary relation between objects of a set V . For example, V can represent the major cities of the world. A line is drawn between any two cities that are linked by a nonstop airline connection. Such a graph will represent the relation “there is a nonstop flight from city (A) to city (B).” In this particular example, the binary relation is likely to

be symmetric, i.e., when there is a nonstop flight from (A) to (B) there is also a nonstop flight from (B) to (A). In such situations, the graph is said to be undirected, as opposed to a general graph which is directed.

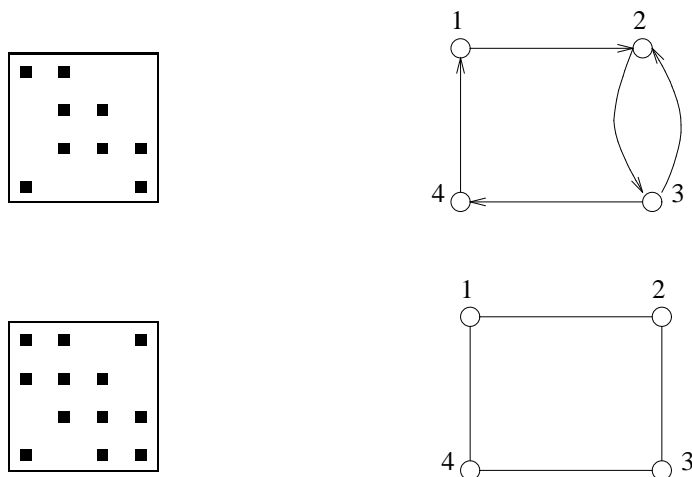

Figure 3.3 Graphs of two 4×4 sparse matrices.

Going back to sparse matrices, the *adjacency graph* of a sparse matrix is a graph $G = (V, E)$, whose n vertices in V represent the n unknowns. Its edges represent the binary relations established by the equations in the following manner: There is an edge from node i to node j when $a_{ij} \neq 0$. This edge will therefore represent the binary relation *equation i involves unknown j* . Note that the graph is directed, except when the matrix has a symmetric pattern ($a_{ij} \neq 0$ iff $a_{ji} \neq 0$ for all $1 \leq i, j \leq n$).

When a matrix has a symmetric nonzero pattern, i.e., when a_{ij} and a_{ji} are always nonzero at the same time, then the graph is *undirected*. Thus, for undirected graphs, every edge points in both directions. As a result, undirected graphs can be represented with nonoriented edges.

As an example of the use of graph models, parallelism in Gaussian elimination can be extracted by finding unknowns that are independent at a given stage of the elimination. These are unknowns which do not depend on each other according to the above binary relation. The rows corresponding to such unknowns can then be used as pivots simultaneously. Thus, in one extreme, when the matrix is diagonal, then all unknowns are independent. Conversely, when a matrix is dense, each unknown will depend on all other unknowns. Sparse matrices lie somewhere between these two extremes.

There are a few interesting simple properties of adjacency graphs. The graph of A^2 can be interpreted as an n -vertex graph whose edges are the pairs (i, j) for which there exists at least one path of length exactly two from node i to node j in the original graph of A . Similarly, the graph of A^k consists of edges which represent the binary relation “there is at least one path of length k from node i to node j .” For details, see Exercise 4.

3.2.2 GRAPHS OF PDE MATRICES

For Partial Differential Equations involving only one physical unknown per mesh point, the adjacency graph of the matrix arising from the discretization is often the graph represented by the mesh itself. However, it is common to have several unknowns per mesh point. For example, the equations modeling fluid flow may involve the two velocity components of the fluid (in two dimensions) as well as energy and momentum at each mesh point. In such situations, there are two choices when labeling the unknowns. They can be labeled contiguously at each mesh point. Thus, for the example just mentioned, we can label all four variables (two velocities followed by momentum and then pressure) at a given mesh point as $u(k), \dots, u(k+3)$. Alternatively, all unknowns associated with one type of variable can be labeled first (e.g., first velocity components), followed by those associated with the second type of variables (e.g., second velocity components), etc. In either case, it is clear that there is redundant information in the graph of the adjacency matrix. The *quotient* graph corresponding to the *physical mesh* can be used instead. This results in substantial savings in storage and computation. In the fluid flow example mentioned above, the storage can be reduced by a factor of almost 16 for the integer arrays needed to represent the graph. This is because the number of edges has been reduced by this much, while the number of vertices, which is usually much smaller, remains the same.

PERMUTATIONS AND REORDERINGS

3.3

Permuting the rows or the columns, or both the rows and columns, of a sparse matrix is a common operation. In fact, *reordering* rows and columns is one of the most important ingredients used in *parallel* implementations of both direct and iterative solution techniques. This section introduces the ideas related to these reordering techniques and their relations to the adjacency graphs of the matrices. Recall the notation introduced in Chapter 1 that the j -th column of a matrix is denoted by a_{*j} and the i -th row by a_{i*} .

3.3.1 BASIC CONCEPTS

We begin with a definition and new notation.

DEFINITION 3.1 Let A be a matrix and $\pi = \{i_1, i_2, \dots, i_n\}$ a permutation of the set $\{1, 2, \dots, n\}$. Then the matrices

$$A_{\pi,*} = \{a_{\pi(i),j}\}_{i=1,\dots,n;j=1,\dots,m},$$

$$A_{*,\pi} = \{a_{i,\pi(j)}\}_{i=1,\dots,n;j=1,\dots,m}$$

are called *row π -permutation* and *column π -permutation* of A , respectively.

It is well known that any permutation of the set $\{1, 2, \dots, n\}$ results from at most n interchanges, i.e., elementary permutations in which only two entries have been interchanged. An *interchange matrix* is the identity matrix with two of its rows interchanged. Denote by X_{ij} such matrices, with i and j being the numbers of the interchanged rows. Note that in order to interchange rows i and j of a matrix A , we only need to premultiply it by the matrix X_{ij} . Let $\pi = \{i_1, i_2, \dots, i_n\}$ be an arbitrary permutation. This permutation is the product of a sequence of n consecutive interchanges $\sigma(i_k, j_k)$, $k = 1, \dots, n$. Then the rows of a matrix can be permuted by interchanging rows i_1, j_1 , then rows i_2, j_2 of the resulting matrix, etc., and finally by interchanging i_n, j_n of the resulting matrix. Each of these operations can be achieved by a premultiplication by X_{i_k, j_k} . The same observation can be made regarding the columns of a matrix: In order to interchange columns i and j of a matrix, postmultiply it by X_{ij} . The following proposition follows from these observations.

PROPOSITION 3.1 *Let π be a permutation resulting from the product of the interchanges $\sigma(i_k, j_k)$, $k = 1, \dots, n$. Then,*

$$A_{\pi,*} = P_{\pi}A, \quad A_{*,\pi} = AQ_{\pi},$$

where

$$P_{\pi} = X_{i_n, j_n} X_{i_{n-1}, j_{n-1}} \cdots X_{i_1, j_1}, \quad (3.1)$$

$$Q_{\pi} = X_{i_1, j_1} X_{i_2, j_2} \cdots X_{i_n, j_n}. \quad (3.2)$$

Products of interchange matrices are called *permutation matrices*. Clearly, a permutation matrix is nothing but the identity matrix with its rows (or columns) permuted.

Observe that $X_{i,j}^2 = I$, i.e., the square of an interchange matrix is the identity, or equivalently, the inverse of an interchange matrix is equal to itself, a property which is intuitively clear. It is easy to see that the matrices (3.1) and (3.2) satisfy

$$P_{\pi}Q_{\pi} = X_{i_n, j_n} X_{i_{n-1}, j_{n-1}} \cdots X_{i_1, j_1} \times X_{i_1, j_1} X_{i_2, j_2} \cdots X_{i_n, j_n} = I,$$

which shows that the two matrices Q_{π} and P_{π} are nonsingular and that they are the inverse of one another. In other words, permuting the rows and the columns of a matrix, *using the same permutation*, actually performs a similarity transformation. Another important consequence arises because the products involved in the definitions (3.1) and (3.2) of P_{π} and Q_{π} occur in reverse order. Since each of the elementary matrices X_{i_k, j_k} is symmetric, the matrix Q_{π} is the transpose of P_{π} . Therefore,

$$Q_{\pi} = P_{\pi}^T = P_{\pi}^{-1}.$$

Since the inverse of the matrix P_{π} is its own transpose, permutation matrices are unitary.

Another way of deriving the above relationships is to express the permutation matrices P_{π} and P_{π}^T in terms of the identity matrix, whose columns or rows are permuted. It can easily be seen (See Exercise 3) that

$$P_{\pi} = I_{\pi,*}, \quad P_{\pi}^T = I_{*,\pi}.$$

It is then possible to verify directly that

$$A_{\pi,*} = I_{\pi,*}A = P_{\pi}A, \quad A_{*,\pi} = AI_{*,\pi} = AP_{\pi}^T.$$

It is important to interpret permutation operations for the linear systems to be solved. When the rows of a matrix are permuted, the order in which the equations are written is changed. On the other hand, when the columns are permuted, the unknowns are in effect *relabelled*, or *reordered*.

Example 3.1 Consider, for example, the linear system $Ax = b$ where

$$A = \begin{pmatrix} a_{11} & 0 & a_{13} & 0 \\ 0 & a_{22} & a_{23} & a_{24} \\ a_{31} & a_{32} & a_{33} & 0 \\ 0 & a_{42} & 0 & a_{44} \end{pmatrix}$$

and $\pi = \{1, 3, 2, 4\}$, then the (column-) permuted linear system is

$$\begin{pmatrix} a_{11} & a_{13} & 0 & 0 \\ 0 & a_{23} & a_{22} & a_{24} \\ a_{31} & a_{33} & a_{32} & 0 \\ 0 & 0 & a_{42} & a_{44} \end{pmatrix} \begin{pmatrix} x_1 \\ x_3 \\ x_2 \\ x_4 \end{pmatrix} = \begin{pmatrix} b_1 \\ b_2 \\ b_3 \\ b_4 \end{pmatrix}.$$

Note that only the unknowns have been permuted, not the equations, and in particular, the right-hand side has not changed.

In the above example, only the columns of A have been permuted. Such one-sided permutations are not as common as two-sided permutations in sparse matrix techniques. In reality, this is often related to the fact that the diagonal elements in linear systems play a distinct and important role. For instance, diagonal elements are typically large in PDE applications and it may be desirable to preserve this important property in the permuted matrix. In order to do so, it is typical to apply the same permutation to both the columns and the rows of A . Such operations are called *symmetric permutations*, and if denoted by $A_{\pi, \pi}$, then the result of such symmetric permutations satisfies the relation

$$A_{\pi, \pi} = P_{\pi}^T A P_{\pi}.$$

The interpretation of the symmetric permutation is quite simple. The resulting matrix corresponds to renaming, or relabeling, or reordering the unknowns and then reordering the equations in the same manner.

Example 3.2 For the previous example, if the rows are permuted with the same permutation as the columns, the linear system obtained is

$$\begin{pmatrix} a_{11} & a_{13} & 0 & 0 \\ a_{31} & a_{33} & a_{32} & 0 \\ 0 & a_{23} & a_{22} & a_{24} \\ 0 & 0 & a_{42} & a_{44} \end{pmatrix} \begin{pmatrix} x_1 \\ x_3 \\ x_2 \\ x_4 \end{pmatrix} = \begin{pmatrix} b_1 \\ b_3 \\ b_2 \\ b_4 \end{pmatrix}.$$

Observe that the diagonal elements are now diagonal elements from the original matrix, placed in a different order on the main diagonal.

3.3.2 RELATIONS WITH THE ADJACENCY GRAPH

From the point of view of graph theory, another important interpretation of a symmetric permutation is that *it is equivalent to relabeling the vertices of the graph* without altering the edges. Indeed, let (i, j) be an edge in the adjacency graph of the original matrix A and let A' be the permuted matrix. Then $a'_{ij} = a_{\pi(i), \pi(j)}$ and a result (i, j) is an edge in the adjacency graph of the permuted matrix A' , if and only if $(\pi(i), \pi(j))$ is an edge in the graph of the original matrix A . Thus, the graph of the permuted matrix has not changed; rather, the labeling of the vertices has. In contrast, nonsymmetric permutations do not preserve the graph. In fact, they can transform an undirected graph into a directed one. Symmetric permutations may have a tremendous impact on the structure of the matrix even though the general graph of the adjacency matrix is identical.

Example 3.3 Consider the matrix illustrated in Figure 3.4 together with its adjacency graph. Such matrices are sometimes called “arrow” matrices because of their shape, but it would probably be more accurate to term them “star” matrices because of the structure of their graphs.

If the equations are reordered using the permutation $9, 8, \dots, 1$, the matrix and graph shown in Figure 3.5 are obtained. Although the difference between the two graphs may seem slight, the matrices have a completely different structure, which may have a significant impact on the algorithms. As an example, if Gaussian elimination is used on the reordered matrix, no fill-in will occur, i.e., the L and U parts of the LU factorization will have the same structure as the lower and upper parts of A , respectively. On the other hand, Gaussian elimination on the original matrix results in disastrous fill-ins. Specifically, the L and U parts of the LU factorization are now dense matrices after the first step of Gaussian elimination. With direct sparse matrix techniques, it is important to find permutations of the matrix that will have the effect of reducing fill-ins during the Gaussian elimination process.

To conclude this section, it should be mentioned that two-sided nonsymmetric permutations may also arise in practice. However, they are more common in the context of direct methods.

3.3.3 COMMON REORDERINGS

The type of reordering, or permutations, used in applications depends on whether a direct or an iterative method is being considered. The following is a sample of such reorderings which are more useful for iterative methods.

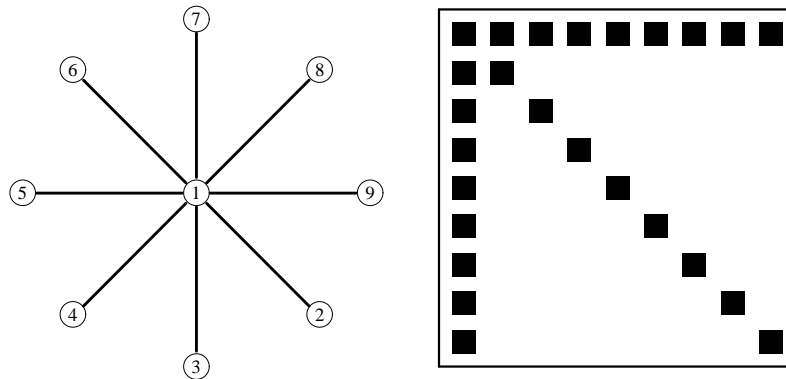

Figure 3.4 Pattern of a 9×9 arrow matrix and its adjacency graph.

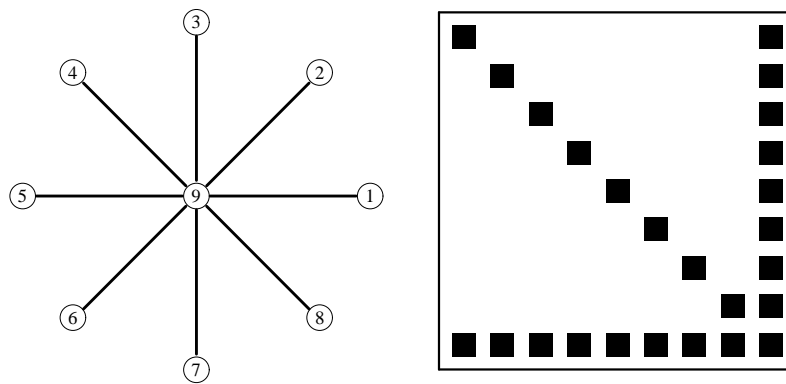

Figure 3.5 Adjacency graph and matrix obtained from above figure after permuting the nodes in reverse order.

Level-set orderings. This class of orderings contains a number of techniques that are based on traversing the graph by *level sets*. A level set is defined recursively as the set of all unmarked neighbors of all the nodes of a previous level set. Initially, a level set consists of one node, although strategies with several starting nodes are also important and will be considered later. As soon as a level set is traversed, its nodes are marked and numbered. They can, for example, be numbered in the order in which they are traversed. In addition, the order in which each level itself is traversed gives rise to different orderings. For instance, the nodes of a certain level can be visited in the natural order in which they are listed. The neighbors of each of these nodes are then inspected. Each time, a neighbor of a visited vertex that is not numbered is encountered, it is added to the list and labeled as

the next element of the next level set. This simple strategy is called *Breadth First Search* (BFS) traversal in graph theory. The ordering will depend on the way in which the nodes are traversed in each level set. In BFS the elements of a level set are always traversed in the natural order in which they are listed. In the *Cuthill-McKee ordering* the elements of a level set are traversed from the nodes of lowest degree to those of highest degree.

ALGORITHM 3.1: Cuthill-McKee Ordering

1. *Input: initial node i_1 ; Output: permutation array iperm .*
 2. *Start: Set $\text{levset} := \{i_1\}$; $\text{next} = 2$;*
 3. *Set $\text{marker}(i_1) = 1$; $\text{iperm}(1) = i_1$*
 4. *While ($\text{next} < n$) Do:*
 5. *$\text{Next_levset} = \emptyset$*
 6. *Traverse levset in order of increasing degree and*
 7. *for each visited node Do:*
 8. *For each neighbor i of j such that $\text{marker}(i) = 0$ Do:*
 9. *Add i to the set Next_levset*
 10. *$\text{marker}(i) := 1$; $\text{iperm}(\text{next}) = i$*
 11. *$\text{next} = \text{next} + 1$*
 12. *EndDo*
 13. *EndDo*
 14. *$\text{levset} := \text{Next_levset}$*
 15. *EndWhile*
-

The iperm array obtained from the procedure lists the nodes in the order in which they are visited and can, in a practical implementation, be used to store the level sets in succession. A pointer is needed to indicate where each set starts. The array iperm thus constructed does in fact represent the permutation array π defined earlier.

In 1971, George [103] observed that *reversing* the Cuthill-McKee ordering yields a better scheme for sparse Gaussian elimination. The simplest way to understand this is to look at the two graphs produced by these orderings. The results of the standard and reversed Cuthill-McKee orderings on the sample finite element mesh problem seen earlier are shown in Figures 3.6 and 3.7, when the initial node is $i_1 = 3$ (relative to the labeling of the original ordering of Figure 2.10). The case of the figure, corresponds to a variant of CMK in which the traversals in Line 6, is done in a random order instead of according to the degree. A large part of the structure of the two matrices consists of little “arrow” submatrices, similar to the ones seen in Example 3.3. In the case of the regular CMK ordering, these arrows point upward, as in Figure 3.4, a consequence of the level set labeling. These blocks are similar the star matrices of Figure 3.4. As a result, Gaussian elimination will essentially fill in the square blocks which they span. As was indicated in Example 3.3, a remedy is to reorder the nodes backward, as is done globally in the reverse Cuthill-McKee strategy. For the reverse CMK ordering, the arrows are pointing downward, as in Figure 3.5, and Gaussian elimination yields much less fill-in.

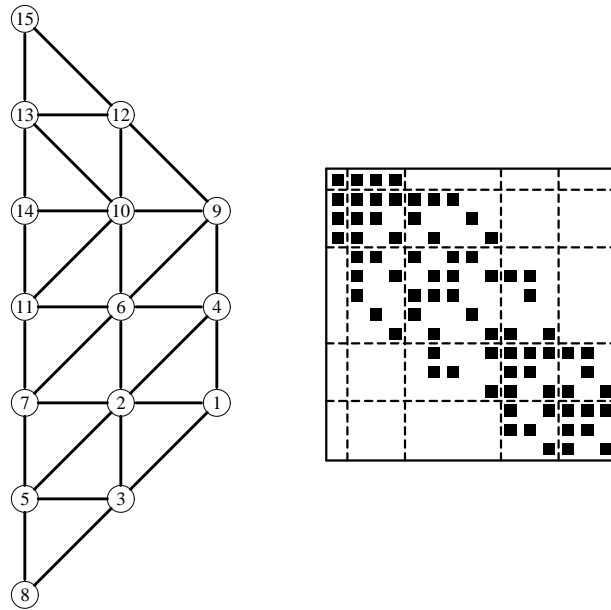

Figure 3.6 *Cuthill-McKee ordering.*

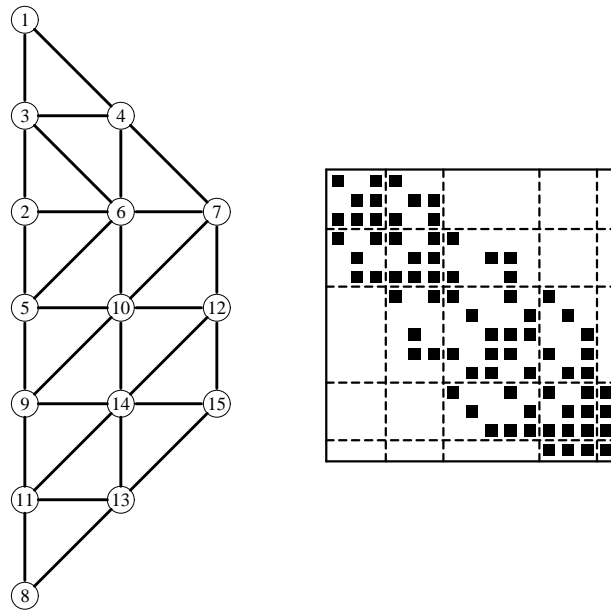

Figure 3.7 *Reverse Cuthill-McKee ordering.*

Example 3.4 The choice of the initial node in the CMK and RCMK orderings may be important. Referring to the original ordering of Figure 2.10, the previous illustration used $i_1 = 3$. However, it is clearly a poor choice if matrices with small bandwidth or *profile* are desired. If $i_1 = 1$ is selected instead, then the reverse Cuthill-McKee algorithm produces the matrix in Figure 3.8, which is more suitable for banded or *skyline* solvers.

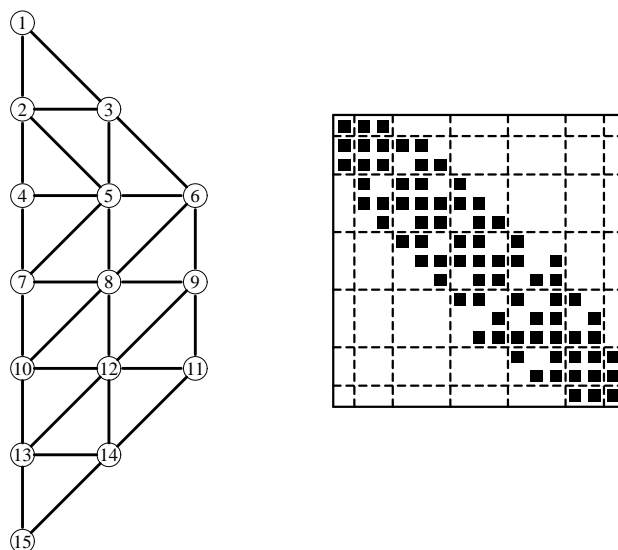

Figure 3.8 Reverse Cuthill-McKee ordering starting with $i_1 = 1$.

Independent set orderings. The matrices that arise in the model finite element problems seen in Figures 2.7, 2.10, and 3.2 are all characterized by an upper-left block that is diagonal, i.e., they have the structure

$$A = \begin{pmatrix} D & E \\ F & C \end{pmatrix}, \quad (3.3)$$

in which D is diagonal and C , E , and F are sparse matrices. The upper-diagonal block corresponds to unknowns from the previous levels of refinement and its presence is due to the ordering of the equations in use. As new vertices are created in the refined grid, they are given new numbers and the initial numbering of the vertices is unchanged. Since the old connected vertices are “cut” by new ones, they are no longer related by equations. Sets such as these are called *independent sets*. Independent sets are especially useful in parallel computing, for implementing both direct and iterative methods.

Referring to the adjacency graph $G = (V, E)$ of the matrix, and denoting by (x, y) the edge from vertex x to vertex y , an *independent set* S is a subset of the vertex set V such that

$$\text{if } x \in S, \quad \text{then } \{(x, y) \in E \text{ or } (y, x) \in E\} \rightarrow y \notin S.$$

To explain this in words: Elements of S are not allowed to be connected to other elements of S either by incoming or outgoing edges. An independent set is *maximal* if it cannot be augmented by elements in its complement to form a larger independent set. Note that a maximal independent set is by no means the largest possible independent set that can be found. In fact, finding the independent set of maximum cardinal is *NP-hard* [132]. In the following, the term *independent set* always refers to *maximal independent set*.

There are a number of simple and inexpensive heuristics for finding large maximal independent sets. A greedy heuristic traverses the nodes in a given order, and if a node is not already marked, it selects the node as a new member of S . Then this node is marked along with its nearest neighbors. Here, a nearest neighbor of a node x means any node linked to x by an incoming or an outgoing edge.

ALGORITHM 3.2: Greedy Algorithm for ISO

1. Set $S = \emptyset$.
 2. For $j = 1, 2, \dots, n$ Do:
 3. If node j is not marked then
 4. $S = S \cup \{j\}$
 5. Mark j and all its nearest neighbors
 6. EndIf
 7. EndDo
-

In the above algorithm, the nodes are traversed in the natural order $1, 2, \dots, n$, but they can also be traversed in any permutation $\{i_1, \dots, i_n\}$ of $\{1, 2, \dots, n\}$. Since the size of the reduced system is $n - |S|$, it is reasonable to try to maximize the size of S in order to obtain a small reduced system. It is possible to give a rough idea of the size of S . Assume that the maximum degree of each node does not exceed ν . Whenever the above algorithm accepts a node as a new member of S , it potentially puts all its nearest neighbors, i.e., at most ν nodes, in the complement of S . Therefore, if s is the size of S , the size of its complement, $n - s$, is such that $n - s \leq \nu s$, and as a result,

$$s \geq \frac{n}{1 + \nu}.$$

This lower bound can be improved slightly by replacing ν with the maximum degree ν_S of all the vertices that constitute S . This results in the inequality

$$s \geq \frac{n}{1 + \nu_S},$$

which suggests that it may be a good idea to first visit the nodes with smaller degrees. In fact, this observation leads to a general heuristic regarding a good order of traversal. The algorithm can be viewed as follows: Each time a node is visited, remove it and its nearest neighbors from the graph, and then visit a node from the remaining graph. Continue in the same manner until all nodes are exhausted. Every node that is visited is a member of S and its nearest neighbors are members of \bar{S} . As result, if ν_i is the degree of the node visited at step i , adjusted for all the edge deletions resulting from the previous visitation steps, then the number n_i of nodes that are left at step i satisfies the relation

$$n_i = n_{i-1} - \nu_i - 1.$$

The process adds a new element to the set S at each step and stops when $n_i = 0$. In order to maximize $|S|$, the number of steps in the procedure must be maximized. The difficulty in the analysis arises from the fact that the degrees are updated at each step i because of the removal of the edges associated with the removed nodes. If the process is to be lengthened, a rule of thumb would be to visit the nodes that have the smallest degrees first.

ALGORITHM 3.3: Increasing Degree Traversal for ISO

1. Set $S = \emptyset$. Find an ordering i_1, \dots, i_n of the nodes by increasing degree.
 2. For $j = 1, 2, \dots, n$, Do:
 3. If node i_j is not marked then
 4. $S = S \cup \{i_j\}$
 5. Mark i_j and all its nearest neighbors
 6. EndIf
 7. EndDo
-

A refinement to the above algorithm would be to update the degrees of all nodes involved in a removal, and dynamically select the one with the smallest degree as the next node to be visited. This can be implemented efficiently using a min-heap data structure. A different heuristic is to attempt to maximize the number of elements in S by a form of local optimization which determines the order of traversal dynamically. In the following, removing a vertex from a graph means deleting the vertex and all edges incident to/from this vertex.

Example 3.5 The algorithms described in this section were tested on the same example used before, namely, the finite element mesh problem of Figure 2.10. Here, all strategies used yield the initial independent set in the matrix itself, which corresponds to the nodes of all the previous levels of refinement. This may well be optimal in this case, i.e., a larger independent set may not exist.

Multicolor orderings. Graph coloring is a familiar problem in computer science which refers to the process of labeling (coloring) the nodes of a graph in such a way that no two adjacent nodes have the same label (color). The goal of graph coloring is to obtain a colored graph which uses the smallest possible number of colors. However, optimality in the context of numerical linear algebra is a secondary issue and simple heuristics do provide adequate colorings.

Basic methods for obtaining a multicoloring of an arbitrary grid are quite simple. They rely on greedy techniques, a simple version of which is as follows.

ALGORITHM 3.4: Greedy Multicoloring Algorithm

1. For $i = 1, \dots, n$ Do: set $Color(i) = 0$.
 2. For $i = 1, 2, \dots, n$ Do:
 3. Set $Color(i) = \min \{k > 0 \mid k \neq Color(j), \forall j \in Adj(i)\}$
 4. EndDo
-

Here, $\text{Adj}(i)$ represents the set of nodes that are adjacent to node i . The color assigned to node i in line 3 is the smallest *allowable* color number which can be assigned to node i . Here, allowable means different from the colors of the nearest neighbors and positive. This procedure is illustrated in Figure 3.9. The node being colored in the figure is indicated by an arrow. It will be assigned color number 3, the smallest positive integer different from 1, 2, 4, 5.

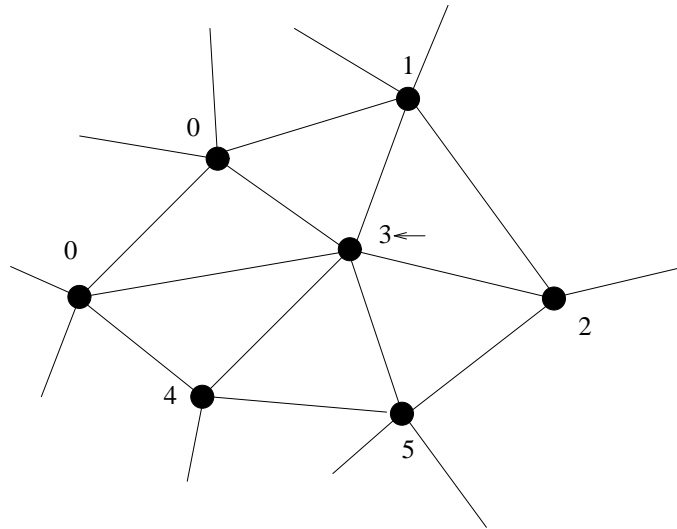

Figure 3.9 *The greedy multicoloring algorithm.*

In the above algorithm, the order $1, 2, \dots, n$ has been arbitrarily selected for traversing the nodes and coloring them. Instead, the nodes can be traversed in any order $\{i_1, i_2, \dots, i_n\}$. If a graph is *bipartite*, i.e., if it can be colored with two colors, then the algorithm will find the optimal two-color (Red-Black) ordering for *Breadth-First* traversals. In addition, if a graph is bipartite, it is easy to show that the algorithm will find two colors for any traversal which, at a given step, visits an unmarked node that is adjacent to at least one visited node. In general, the number of colors needed does not exceed the maximum degree of each node $+1$. These properties are the subject of Exercises 9 and 8.

Example 3.6 Figure 3.10 illustrates the algorithm for the same example used earlier, i.e., the finite element mesh problem of Figure 2.10. The dashed lines separate the different color sets found. Four colors are found in this example.

Once the colors have been found, the matrix can be permuted to have a block structure in which the diagonal blocks are diagonal. Alternatively, the color sets $S_j = [i_1^{(j)}, \dots, i_{n_j}^{(j)}]$ and the permutation array in the algorithms can be used.

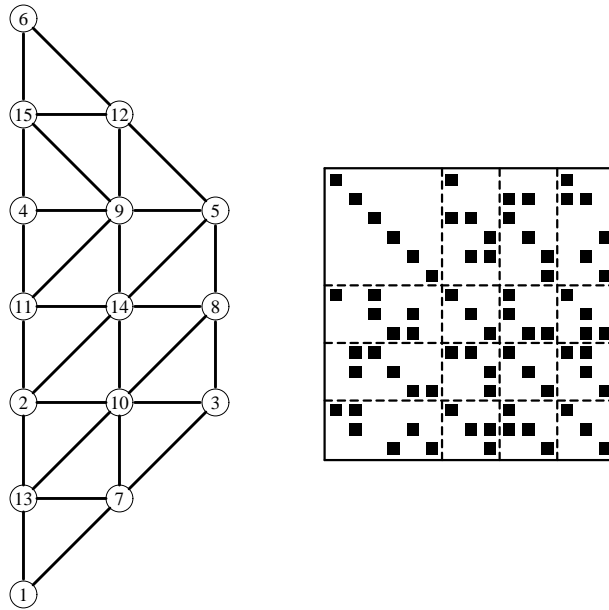

Figure 3.10 Graph and matrix corresponding to mesh of Figure 2.10 after multicolor ordering.

3.3.4 IRREDUCIBILITY

Remember that a *path* in a graph is a sequence of vertices v_1, v_2, \dots, v_k , which are such that (v_i, v_{i+1}) is an edge for $i = 1, \dots, k - 1$. Also, a graph is said to be *connected* if there is a path between any pair of vertices in V . A *connected component* in a graph is a *maximal subset* of vertices which all can be connected to one another by paths in the graph. Now consider matrices whose graphs may be *directed*. A matrix is *reducible* if its graph is not connected, and *irreducible* otherwise. When a matrix is reducible, then it can be permuted by means of *symmetric* permutations into a block upper triangular matrix of the form

$$\begin{pmatrix} A_{11} & A_{12} & A_{13} & \dots \\ & A_{22} & A_{23} & \dots \\ & & \ddots & \vdots \\ & & & A_{pp} \end{pmatrix},$$

where each partition corresponds to a connected component. It is clear that linear systems with the above matrix can be solved through a sequence of subsystems with the matrices A_{ii} , $i = p, p - 1, \dots, 1$.

STORAGE SCHEMES

3.4

In order to take advantage of the large number of zero elements, special schemes are required to store sparse matrices. The main goal is to represent only the nonzero elements, and to be able to perform the common matrix operations. In the following, Nz denotes the total number of nonzero elements. Only the most popular schemes are covered here, but additional details can be found in books such as Duff, Erisman, and Reid [77].

The simplest storage scheme for sparse matrices is the so-called coordinate format. The data structure consists of three arrays: (1) a real array containing all the real (or complex) values of the nonzero elements of A in any order; (2) an integer array containing their row indices; and (3) a second integer array containing their column indices. All three arrays are of length Nz , the number of nonzero elements.

Example 3.7 The matrix

$$A = \begin{pmatrix} 1. & 0. & 0. & 2. & 0. \\ 3. & 4. & 0. & 5. & 0. \\ 6. & 0. & 7. & 8. & 9. \\ 0. & 0. & 10. & 11. & 0. \\ 0. & 0. & 0. & 0. & 12. \end{pmatrix}$$

will be represented (for example) by

AA	12.	9.	7.	5.	1.	2.	11.	3.	6.	4.	8.	10.
JR	5	3	3	2	1	1	4	2	3	2	3	4
JC	5	5	3	4	1	4	4	1	1	2	4	3

In the above example, the elements are listed in an arbitrary order. In fact, they are usually listed by row or columns. If the elements were listed by row, the array JC which contains redundant information might be replaced by an array which points to the beginning of each row instead. This would involve nonnegligible savings in storage. The new data structure has three arrays with the following functions:

- A real array AA contains the real values a_{ij} stored row by row, from row 1 to n . The length of AA is Nz .
- An integer array JA contains the column indices of the elements a_{ij} as stored in the array AA . The length of JA is Nz .
- An integer array IA contains the pointers to the beginning of each row in the arrays AA and JA . Thus, the content of $IA(i)$ is the position in arrays AA and JA where the i -th row starts. The length of IA is $n + 1$ with $IA(n + 1)$ containing the number $IA(1) + Nz$, i.e., the address in A and JA of the beginning of a fictitious row number $n + 1$.

Thus, the above matrix may be stored as follows:

AA	1. 2. 3. 4. 5. 6. 7. 8. 9. 10. 11. 12.
JA	1 4 1 2 4 1 3 4 5 3 4 5
IA	1 3 6 10 12 13

This format is probably the most popular for storing general sparse matrices. It is called the *Compressed Sparse Row* (CSR) format. This scheme is preferred over the coordinate scheme because it is often more useful for performing typical computations. On the other hand, the coordinate scheme is advantageous for its simplicity and its flexibility. It is often used as an “entry” format in sparse matrix software packages.

There are a number of variations for the Compressed Sparse Row format. The most obvious variation is storing the columns instead of the rows. The corresponding scheme is known as the *Compressed Sparse Column* (CSC) scheme.

Another common variation exploits the fact that the diagonal elements of many matrices are all usually nonzero and/or that they are accessed more often than the rest of the elements. As a result, they can be stored separately. The *Modified Sparse Row* (MSR) format has only two arrays: a real array AA and an integer array JA . The first n positions in AA contain the diagonal elements of the matrix in order. The position $n + 1$ of the array AA is not used, but may sometimes be used to carry other information concerning the matrix. Starting at position $n + 2$, the nonzero elements of AA , excluding its diagonal elements, are stored by row. For each element $AA(k)$, the integer $JA(k)$ represents its column index on the matrix. The $n + 1$ first positions of JA contain the pointer to the beginning of each row in AA and JA . Thus, for the above example, the two arrays will be as follows:

AA	1. 4. 7. 11. 12. * 2. 3. 5. 6. 8. 9. 10.
JA	7 8 10 13 14 14 4 1 4 1 4 5 3

The star denotes an unused location. Notice that $JA(n) = JA(n + 1) = 14$, indicating that the last row is a zero row, once the diagonal element has been removed.

Diagonally structured matrices are matrices whose nonzero elements are located along a small number of diagonals. These diagonals can be stored in a rectangular array $DIAG(1:n, 1:Nd)$, where Nd is the number of diagonals. The offsets of each of the diagonals with respect to the main diagonal must be known. These will be stored in an array $IOFF(1:Nd)$. Thus, the element $a_{i, i+ioff(j)}$ of the original matrix is located in position (i, j) of the array $DIAG$, i.e.,

$$DIAG(i, j) \leftarrow a_{i, i+ioff(j)}.$$

The order in which the diagonals are stored in the columns of $DIAG$ is generally unimportant, though if several more operations are performed with the main diagonal, storing it in the first column may be slightly advantageous. Note also that all the diagonals except the main diagonal have fewer than n elements, so there are positions in $DIAG$ that will not be used.

Example 3.8 For example, the following matrix which has three diagonals

$$A = \begin{pmatrix} 1. & 0. & 2. & 0. & 0. \\ 3. & 4. & 0. & 5. & 0. \\ 0. & 6. & 7. & 0. & 8. \\ 0. & 0. & 9. & 10. & 0. \\ 0. & 0. & 0. & 11. & 12. \end{pmatrix}$$

will be represented by the two arrays

$$\text{DIAG} = \begin{array}{|c|c|c|} \hline * & 1. & 2. \\ \hline 3. & 4. & 5. \\ \hline 6. & 7. & 8. \\ \hline 9. & 10. & * \\ \hline 11 & 12. & * \\ \hline \end{array} \quad \text{IOFF} = \begin{array}{|c|c|c|} \hline -1 & 0 & 2 \\ \hline \end{array}.$$

A more general scheme which is popular on vector machines is the so-called Ellpack-Itpack format. The assumption in this scheme is that there are at most Nd nonzero elements per row, where Nd is small. Then two rectangular arrays of dimension $n \times Nd$ each are required (one real and one integer). The first, COEF, is similar to DIAG and contains the nonzero elements of A . The nonzero elements of each row of the matrix can be stored in a row of the array COEF(1:n, 1:Nd), completing the row by zeros as necessary. Together with COEF, an integer array JCOEF(1:n, 1:Nd) must be stored which contains the column positions of each entry in COEF.

Example 3.9 Thus, for the matrix of the previous example, the Ellpack-Itpack storage scheme is

$$\text{COEF} = \begin{array}{|c|c|c|} \hline 1. & 2. & 0. \\ \hline 3. & 4. & 5. \\ \hline 6. & 7. & 8. \\ \hline 9. & 10. & 0. \\ \hline 11 & 12. & 0. \\ \hline \end{array} \quad \text{JCOEF} = \begin{array}{|c|c|c|} \hline 1 & 3 & 1 \\ \hline 1 & 2 & 4 \\ \hline 2 & 3 & 5 \\ \hline 3 & 4 & 4 \\ \hline 4 & 5 & 5 \\ \hline \end{array}.$$

A certain column number must be chosen for each of the zero elements that must be added to pad the shorter rows of A , i.e., rows 1, 4, and 5. In this example, those integers are selected to be equal to the row numbers, as can be seen in the JCOEF array. This is somewhat arbitrary, and in fact, any integer between 1 and n would be acceptable. However, there may be good reasons for not inserting the same integers too often, e.g. a constant number, for performance considerations.

BASIC SPARSE MATRIX OPERATIONS

3.5

The matrix-by-vector product is an important operation which is required in most of the iterative solution algorithms for solving sparse linear systems. This section shows how these can be implemented for a small subset of the storage schemes considered earlier.

The following Fortran 90 segment shows the main loop of the matrix-by-vector operation for matrices stored in the Compressed Sparse Row stored format.

```

DO I=1, N
  K1 = IA(I)
  K2 = IA(I+1)-1
  Y(I) = DOTPRODUCT(A(K1:K2), X(JA(K1:K2)))
ENDDO

```

Notice that each iteration of the loop computes a different component of the resulting vector. This is advantageous because each of these components can be computed independently. If the matrix is stored by columns, then the following code could be used instead:

```

DO J=1, N
  K1 = IA(J)
  K2 = IA(J+1)-1
  Y(JA(K1:K2)) = Y(JA(K1:K2)) + X(J) * A(K1:K2)
ENDDO

```

In each iteration of the loop, a multiple of the j -th column is added to the result, which is assumed to have been initially set to zero. Notice now that the outer loop is no longer parallelizable. An alternative to improve parallelization is to try to split the vector operation in each inner loop. The inner loop has few operations, in general, so this is unlikely to be a sound approach. This comparison demonstrates that data structures may have to change to improve performance when dealing with high performance computers.

Now consider the matrix-by-vector product in diagonal storage.

```

DO J=1, N
  JOFF = IOFF(J)
  DO I=1, N
    Y(I) = Y(I) +DIAG(I, J)*X(JOFF+I)
  ENDDO
ENDDO

```

Here, each of the diagonals is multiplied by the vector x and the result added to the vector y . It is again assumed that the vector y has been filled with zeros at the start of the loop. From the point of view of parallelization and/or vectorization, the above code is probably the better to use. On the other hand, it is not general enough.

Solving a lower or upper triangular system is another important “kernel” in sparse matrix computations. The following segment of code shows a simple routine for solving a unit lower triangular system $Lx = y$ for the CSR storage format.

```

X(1) = Y(1)
DO I = 2, N
  K1 = IAL(I)
  K2 = IAL(I+1)-1
  X(I)=Y(I)-DOTPRODUCT(AL(K1:K2),X(JAL(K1:K2)))
ENDDO

```

At each step, the inner product of the current solution x with the i -th row is computed and subtracted from $y(i)$. This gives the value of $x(i)$. The `dotproduct` function computes the dot product of two arbitrary vectors $u(k1:k2)$ and $v(k1:k2)$. The vector `AL(K1:K2)` is the i -th row of the matrix L in sparse format and `X(JAL(K1:K2))` is the vector of the components of X gathered into a short vector which is consistent with the column indices of the elements in the row `AL(K1:K2)`.

SPARSE DIRECT SOLUTION METHODS

3.6

Most direct methods for sparse linear systems perform an LU factorization of the original matrix and try to reduce cost by minimizing fill-ins, i.e., nonzero elements introduced during the elimination process in positions which were initially zeros. The data structures employed are rather complicated. The early codes relied heavily on *linked lists* which are convenient for inserting new nonzero elements. Linked-list data structures were dropped in favor of other more dynamic schemes that leave some initial elbow room in each row for the insertions, and then adjust the structure as more fill-ins are introduced.

A typical sparse direct solution solver for positive definite matrices consists of four phases. First, preordering is applied to minimizing fill-in. Two popular methods are used: minimal degree ordering and nested-dissection ordering. Second, a symbolic factorization is performed. This means that the factorization is processed only symbolically, i.e., without numerical values. Third, the numerical factorization, in which the actual factors L and U are formed, is processed. Finally, the forward and backward triangular sweeps are executed for each different right-hand side. In a code where numerical pivoting is necessary, the symbolic phase cannot be separated from the numerical factorization.

TEST PROBLEMS

3.7

For comparison purposes it is important to use a common set of test matrices that represent a wide spectrum of applications. There are two distinct ways of providing such data sets. The first approach is to collect sparse matrices in a well-specified standard format from various applications. This approach is used in the Harwell-Boeing collection of test matrices. The second approach is to generate these matrices with a few sample programs such

as those provided in the SPARSKIT library [179]. The coming chapters will use examples from these two sources. In particular, five test problems will be emphasized for their varying degrees of difficulty.

The SPARSKIT package can generate matrices arising from the discretization of the two- or three-dimensional Partial Differential Equations

$$-\frac{\partial}{\partial x} \left(a \frac{\partial u}{\partial x} \right) - \frac{\partial}{\partial y} \left(b \frac{\partial u}{\partial y} \right) - \frac{\partial}{\partial z} \left(c \frac{\partial u}{\partial z} \right) + \frac{\partial (du)}{\partial x} + \frac{\partial (eu)}{\partial y} + \frac{\partial (fu)}{\partial z} + gu = h$$

on rectangular regions with general mixed-type boundary conditions. In the test problems, the regions are the square $\Omega = (0, 1)^2$, or the cube $\Omega = (0, 1)^3$; the Dirichlet condition $u = 0$ is always used on the boundary. Only the discretized matrix is of importance, since the right-hand side will be created artificially. Therefore, the right-hand side, h , is not relevant.

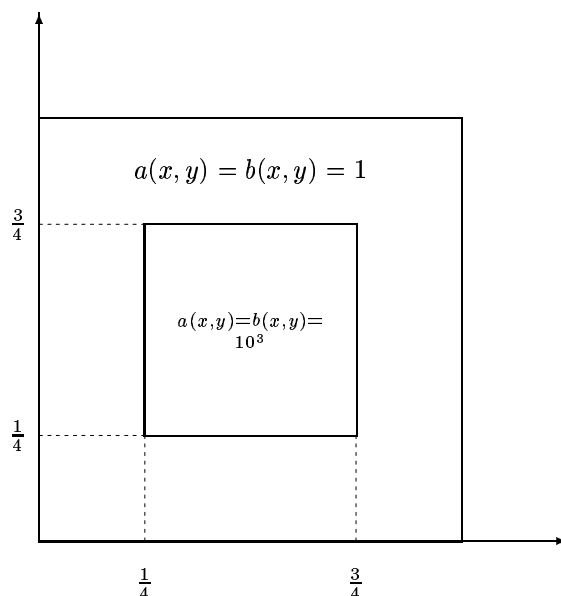

Figure 3.11 Physical domain and coefficients for Problem 1.

Problem 1: F2DA. In the first test problem which will be labeled F2DA, the domain is two-dimensional, with

$$a(x, y) = b(x, y) = 1.0$$

and

$$d(x, y) = \gamma(x + y), \quad e(x, y) = \gamma(x - y), \quad f(x, y) = g(x, y) = 0.0, \quad (3.4)$$

where the constant γ is equal to 10. The domain and coefficients for this problem are shown in Figure 3.11. If the number of points in each direction is 34, then there are $n_x = n_y = 32$

interior points in each direction and a matrix of size $n = n_x \times n_y = 32^2 = 1024$ is obtained. In this test example, as well as the other ones described below, the right-hand side is generated as

$$b = Ae,$$

in which $e = (1, 1, \dots, 1)^T$. The initial guess is always taken to be a vector of pseudo-random values.

Problem 2: F2DB. The second test problem is similar to the previous one but involves discontinuous coefficient functions a and b . Here, $n_x = n_y = 32$ and the functions d, e, f, g are also defined by (3.4). However, the functions a and b now both take the value 1,000 inside the subsquare of width $\frac{1}{2}$ centered at $(\frac{1}{2}, \frac{1}{2})$, and one elsewhere in the domain, i.e.,

$$a(x, y) = b(x, y) = \begin{cases} 10^3 & \text{if } \frac{1}{4} < x, y < \frac{3}{4} \\ 1 & \text{otherwise} \end{cases}.$$

Problem 3: F3D. The third test problem is three-dimensional with $n_x = n_y = n_z = 16$ internal mesh points in each direction leading to a problem of size $n = 4096$. In this case, we take

$$a(x, y, z) = b(x, y, z) = c(x, y, z) = 1$$

$$d(x, y, z) = \gamma e^{xy}, \quad e(x, y, z) = \gamma e^{-xy},$$

and

$$f(x, y, z) = g(x, y, z) = 0.0.$$

The constant γ is taken to be equal to 10.0 as before.

The Harwell-Boeing collection is a large data set consisting of test matrices which have been contributed by researchers and engineers from many different disciplines. These have often been used for test purposes in the literature [78]. The collection provides a data structure which constitutes an excellent medium for exchanging matrices. The matrices are stored as ASCII files with a very specific format consisting of a four- or five-line header. Then, the data containing the matrix is stored in CSC format together with any right-hand sides, initial guesses, or exact solutions when available. The SPARSKIT library also provides routines for reading and generating matrices in this format.

Only one matrix from the collection was selected for testing the algorithms described in the coming chapters. The matrices in the last two test examples are both irregularly structured.

Problem 4: ORS The matrix selected from the Harwell-Boeing collection is ORSIRR1. This matrix arises from a reservoir engineering problem. Its size is $n = 1030$ and it has a total of $Nz = 6,858$ nonzero elements. The original problem is based on a $21 \times 21 \times 5$ irregular grid. In this case and the next one, the matrices are preprocessed by scaling their rows and columns.

Problem 5: FID This test matrix is extracted from the well known fluid flow simulation package FIDAP [84]. It is actually the test example number 36 from this package and features a two-dimensional Chemical Vapor Deposition in a Horizontal Reactor. The matrix has a size of $n = 3079$ and has $Nz = 53843$ nonzero elements. It has a symmetric pattern and few diagonally dominant rows or columns. The rows and columns are prescaled in the same way as in the previous example. Figure 3.12 shows the patterns of the matrices ORS and FID.

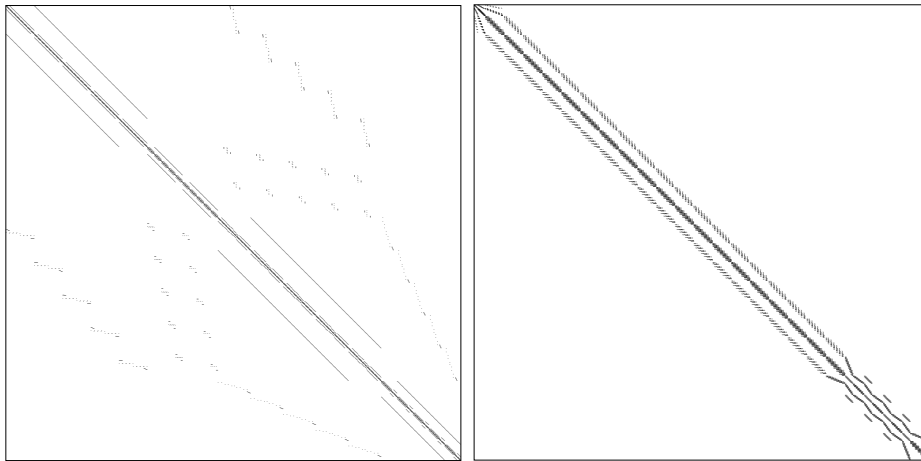

Figure 3.12 Patterns of the matrices ORS (left) and FID (right).

EXERCISES

1. Consider the mesh of a discretized PDE. In which situations is the graph representing this mesh the same as the adjacency graph of the matrix? Give examples from both Finite Difference and Finite Element discretizations.
2. Let A and B be two sparse (square) matrices of the same dimension. How can the graph of $C = A + B$ be characterized with respect to the graphs of A and B ?
3. Consider the matrix defined as

$$P_{\pi} = I_{\pi, *}$$

Show directly (without using Proposition 3.1 or interchange matrices) that the following three relations hold

$$\begin{aligned} A_{\pi, *} &= I_{\pi, *} A \\ I_{*, \pi} &= P_{\pi}^T \\ AP_{\pi}^T &= A_{*, \pi}. \end{aligned}$$

4. Consider the two matrices

$$A = \begin{pmatrix} * & * & 0 & * & 0 & 0 \\ 0 & * & 0 & 0 & 0 & * \\ 0 & * & * & 0 & 0 & 0 \\ 0 & * & 0 & 0 & * & 0 \\ 0 & 0 & 0 & 0 & * & 0 \\ 0 & 0 & 0 & 0 & 0 & * \end{pmatrix} \quad B = \begin{pmatrix} * & 0 & 0 & 0 & 0 & 0 \\ * & 0 & * & 0 & * & 0 \\ 0 & * & 0 & 0 & 0 & 0 \\ * & * & 0 & 0 & 0 & 0 \\ 0 & * & 0 & * & * & 0 \\ 0 & 0 & * & 0 & 0 & * \end{pmatrix}$$

where a $*$ represents an arbitrary nonzero element.

- Show the adjacency graphs of the matrices A , B , AB , and BA . (Assume that there are no numerical cancellations in computing the products AB and BA). Since there are zero diagonal elements, represent explicitly the cycles corresponding to the (i, i) edges when they are present.
 - Consider the matrix $C = AB$. Give an interpretation of an edge in the graph of C in terms of edges in the graph of A and B . Verify this answer using the above matrices.
 - Consider the particular case in which $B = A$. Give an interpretation of an edge in the graph of C in terms of paths of length two in the graph of A . The paths must take into account the cycles corresponding to nonzero diagonal elements of A .
 - Now consider the case where $B = A^2$. Give an interpretation of an edge in the graph of $C = A^3$ in terms of paths of length three in the graph of A . Generalize the result to arbitrary powers of A .
5. Consider a 6×6 matrix which has the pattern

$$A = \begin{pmatrix} * & * & & * & & \\ * & * & * & & & * \\ & * & * & & & \\ * & & & * & * & \\ & * & & * & * & * \\ & & & * & * & \end{pmatrix}.$$

- Show the adjacency graph of A .
 - Consider the permutation $\pi = \{1, 3, 4, 2, 5, 6\}$. Show the adjacency graph and new pattern for the matrix obtained from a symmetric permutation of A based on the permutation array π .
6. Consider a matrix which has the pattern

$$A = \begin{pmatrix} * & * & & * & & * \\ * & * & * & & * & \\ & * & * & * & & * \\ * & & * & * & * & \\ & * & & * & * & * \\ & & * & * & * & \\ * & & * & & * & * \end{pmatrix}.$$

- Show the adjacency graph of A . (Place the 8 vertices on a circle.)
- Consider the permutation $\pi = \{1, 3, 5, 7, 2, 4, 6, 8\}$. Show the adjacency graph and new pattern for the matrix obtained from a symmetric permutation of A based on the permutation array π .
- Show the adjacency graph and new pattern for the matrix obtained from a reverse Cuthill-McKee ordering of A starting with the node 1. (Assume the vertices adjacent to a given vertex are always listed in increasing order in the data structure that describes the graph.)

- d.* Find a multicolor ordering for A (give the vertex labels color 1, followed by those for color 2, etc.).
7. Given a five-point finite difference graph, show that the greedy algorithm will always find a coloring of the graph with two colors.
8. Prove that the total number of colors found by the greedy multicoloring algorithm does not exceed $\nu_{max} + 1$, where ν_{max} is the maximum degree of all the vertices of a graph (not counting the cycles (i, i) associated with diagonal elements).
9. Consider a graph that is bipartite, i.e., 2-colorable. Assume that the vertices of the graph are colored by a variant of Algorithm (3.4), in which the nodes are traversed in a certain order i_1, i_2, \dots, i_n .
- a.* Is it true that for any permutation i_1, \dots, i_n the number of colors found will be two?
- b.* Consider now a permutation satisfying the following property: for each j at least one of the nodes i_1, i_2, \dots, i_{j-1} is adjacent to i_j . Show that the algorithm will find a 2-coloring of the graph.
- c.* Among the following traversals indicate which ones satisfy the property of the previous question: (1) Breadth-First Search, (2) random traversal, (3) traversal defined by $i_j =$ any node adjacent to i_{j-1} .
10. Given a matrix that is irreducible and with a symmetric pattern, show that its structural inverse is dense. Structural inverse means the pattern of the inverse, regardless of the values, or otherwise stated, is the union of all patterns of the inverses for all possible values. [Hint: Use Cayley Hamilton's theorem and a well known result on powers of adjacency matrices mentioned at the end of Section 3.2.1.]
11. The most economical storage scheme in terms of memory usage is the following variation on the coordinate format: Store all nonzero values a_{ij} in a real array $AA[1 : Nz]$ and the corresponding "linear array address" $(i - 1) * n + j$ in an integer array $JA[1 : Nz]$. The order in which these corresponding entries are stored is unimportant as long as they are both in the same position in their respective arrays. What are the advantages and disadvantages of this data structure? Write a short routine for performing a matrix-by-vector product in this format.
12. Write a FORTRAN code segment to perform the matrix-by-vector product for matrices stored in Ellpack-Itpack format.
13. Write a small subroutine to perform the following operations on a sparse matrix in coordinate format, diagonal format, and CSR format:
- a.* Count the number of nonzero elements in the main diagonal;
- b.* Extract the diagonal whose offset is k ;
- c.* Add a nonzero element in position (i, j) of the matrix (this position may initially contain a zero or a nonzero element);
- d.* Add a given diagonal to the matrix. What is the most convenient storage scheme for each of these operations?
14. Linked lists is another popular scheme often used for storing sparse matrices. These allow to link together k data items (e.g., elements of a given row) in a large linear array. A starting position is given in the array which contains the first element of the set. Then, a link to the next element in the array is provided from a LINK array.
- a.* Show how to implement this scheme. A linked list is to be used for each row.
- b.* What are the main advantages and disadvantages of linked lists?

- c. Write an algorithm to perform a matrix-by-vector product in this format.
-

NOTES AND REFERENCES. Two good references on sparse matrix computations are the book by George and Liu [104] and the more recent volume by Duff, Erisman, and Reid [77]. These are geared toward direct solution methods and the first specializes in symmetric positive definite problems. Also of interest are [157] and [163] and the early survey by Duff [76].

Sparse matrix techniques have traditionally been associated with direct solution methods. Clearly, this is now changing rapidly since the sophistication of iterative solution packages is starting to equal that of direct solvers. The SPARSKIT library, a package for sparse matrix computations [179] is currently in its second version and is available through anonymous FTP (<http://www.cs.umn.edu/Research/arpa/SPARSKIT>). Another available software package which emphasizes object-oriented design with the goal of hiding complex data structures from users is PETSc [19]. A manipulation package for sparse matrices, similar to SPARSKIT in spirit, is SMMS developed by Alvarado [6].

The idea of the greedy multicoloring algorithm is known in Finite Element techniques (to color elements); see, e.g., Benantar and Flaherty [23]. Wu [229] presents the greedy algorithm for multicoloring vertices and uses it for SOR type iterations, see also [182]. The effect of multicoloring has been extensively studied by Adams [2, 3] and Poole and Ortega [164]. Interesting results regarding multicoloring in the context of finite elements based on quad-tree structures have been obtained by Benantar and Flaherty [23] who show, in particular, that with this structure a maximum of six colors is required. ■

BASIC ITERATIVE METHODS

The first iterative methods used for solving large linear systems were based on *relaxation of the coordinates*. Beginning with a given approximate solution, these methods modify the components of the approximation, one or a few at a time and in a certain order, until convergence is reached. Each of these modifications, called relaxation steps, is aimed at annihilating one or a few components of the residual vector. Now, these techniques are rarely used separately. However, when combined with the more efficient methods described in later chapters, they can be quite successful. Moreover, there are a few application areas where variations of these methods are still quite popular.

JACOBI, GAUSS-SEIDEL, AND SOR

4.1

This chapter begins by reviewing the basic iterative methods for solving linear systems. Given an $n \times n$ real matrix A and a real n -vector b , the problem considered is: Find x belonging to \mathbb{R}^n such that

$$Ax = b \tag{4.1}$$

Equation (4.1) is a *linear system*, A is the *coefficient matrix*, b is the *right-hand side* vector, and x is the *vector of unknowns*. Most of the methods covered in this chapter involve passing from one iterate to the next by modifying one or a few components of an approximate vector solution at a time. This is natural since there are simple criteria when modifying a component in order to improve an iterate. One example is to annihilate some component(s) of the residual vector $b - Ax$. The convergence of these methods is rarely guaranteed for all matrices, but a large body of theory exists for the case where the coefficient matrix arises from the finite difference discretization of Elliptic Partial Differential Equations.

We begin with the decomposition

$$A = D - E - F, \quad (4.2)$$

in which D is the diagonal of A , $-E$ its strict lower part, and $-F$ its strict upper part, as illustrated in Figure 4.1. It is always assumed that the diagonal entries of A are all nonzero.

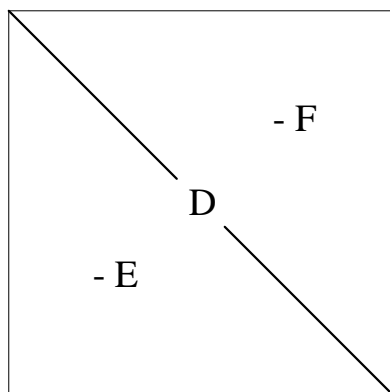

Figure 4.1 Initial partitioning of matrix A .

The Jacobi iteration determines the i -th component of the next approximation so as to annihilate the i -th component of the residual vector. In the following, $\xi_i^{(k)}$ denotes the i -th component of the iterate x_k and β_i the i -th component of the right-hand side b . Thus, writing

$$(b - Ax_{k+1})_i = 0, \quad (4.3)$$

in which $(y)_i$ represents the i -th component of the vector y , yields

$$a_{ii}\xi_i^{(k+1)} = - \sum_{\substack{j=1 \\ j \neq i}}^n a_{ij}\xi_j^{(k)} + \beta_i,$$

or

$$\xi_i^{(k+1)} = \frac{1}{a_{ii}} \left(\beta_i - \sum_{\substack{j=1 \\ j \neq i}}^n a_{ij}\xi_j^{(k)} \right) \quad i = 1, \dots, n. \quad (4.4)$$

This is a component-wise form of the Jacobi iteration. All components of the next iterate can be grouped into the vector x_{k+1} . The above notation can be used to rewrite the Jacobi iteration (4.4) in vector form as

$$x_{k+1} = D^{-1}(E + F)x_k + D^{-1}b. \quad (4.5)$$

Similarly, the Gauss-Seidel iteration corrects the i -th component of the current approximate solution, in the order $i = 1, 2, \dots, n$, again to annihilate the i -th component of the residual. However, this time the approximate solution is updated immediately after the new component is determined. The newly computed components $\xi_i^{(k)}$, $i = 1, 2, \dots, n$ can be changed within a working vector which is redefined at each relaxation step. Thus, since

the order is $i = 1, 2, \dots$, the result at the i -th step is

$$\beta_i - \sum_{j=1}^{i-1} a_{ij} \xi_j^{(k+1)} - a_{ii} \xi_i^{(k+1)} - \sum_{j=i+1}^n a_{ij} \xi_j^{(k)} = 0, \quad (4.6)$$

which leads to the iteration,

$$\xi_i^{(k+1)} = \frac{1}{a_{ii}} \left(- \sum_{j=1}^{i-1} a_{ij} \xi_j^{(k+1)} - \sum_{j=i+1}^n a_{ij} \xi_j^{(k)} + \beta_i \right), \quad i = 1, \dots, n. \quad (4.7)$$

The defining equation (4.6) can be written as

$$b + Ex_{k+1} - Dx_{k+1} + Fx_k = 0,$$

which leads immediately to the vector form of the Gauss-Seidel iteration

$$x_{k+1} = (D - E)^{-1} Fx_k + (D - E)^{-1} b. \quad (4.8)$$

Computing the new approximation in (4.5) requires multiplying by the inverse of the diagonal matrix D . In (4.8) a triangular system must be solved with $D - E$, the lower triangular part of A . Thus, the new approximation in a Gauss-Seidel step can be determined either by solving a triangular system with the matrix $D - E$ or from the relation (4.7).

A *backward* Gauss-Seidel iteration can also be defined as

$$(D - F)x_{k+1} = Ex_k + b, \quad (4.9)$$

which is equivalent to making the coordinate corrections in the order $n, n-1, \dots, 1$. A Symmetric Gauss-Seidel Iteration consists of a forward sweep followed by a backward sweep.

The Jacobi and the Gauss-Seidel iterations are both of the form

$$Mx_{k+1} = Nx_k + b = (M - A)x_k + b, \quad (4.10)$$

in which

$$A = M - N \quad (4.11)$$

is a *splitting* of A , with $M = D$ for Jacobi, $M = D - E$ for forward Gauss-Seidel, and $M = D - F$ for backward Gauss-Seidel. An iterative method of the form (4.10) can be defined for any splitting of the form (4.11) where M is nonsingular. *Overrelaxation* is based on the splitting

$$\omega A = (D - \omega E) - (\omega F + (1 - \omega)D),$$

and the corresponding *Successive Over Relaxation* (SOR) method is given by the recursion

$$(D - \omega E)x_{k+1} = [\omega F + (1 - \omega)D]x_k + \omega b. \quad (4.12)$$

The above iteration corresponds to the relaxation sequence

$$\xi_i^{(k+1)} = \omega \xi_i^{GS} + (1 - \omega) \xi_i^{(k)}, \quad i = 1, 2, \dots, n,$$

in which ξ_i^{GS} is defined by the expression in the right-hand side of (4.7). A backward SOR sweep can be defined analogously to the backward Gauss-Seidel sweep (4.9).

A Symmetric SOR (SSOR) step consists of the SOR step (4.12) followed by a backward SOR step,

$$\begin{aligned}(D - \omega E)x_{k+1/2} &= [\omega F + (1 - \omega)D]x_k + \omega b \\ (D - \omega F)x_{k+1} &= [\omega E + (1 - \omega)D]x_{k+1/2} + \omega b\end{aligned}$$

This gives the recurrence

$$x_{k+1} = G_\omega x_k + f_\omega,$$

where

$$G_\omega = (D - \omega F)^{-1}(\omega E + (1 - \omega)D) \times (D - \omega E)^{-1}(\omega F + (1 - \omega)D), \quad (4.13)$$

$$f_\omega = \omega(D - \omega F)^{-1} (I + [\omega E + (1 - \omega)D](D - \omega E)^{-1}) b. \quad (4.14)$$

Observing that

$$\begin{aligned}[\omega E + (1 - \omega)D](D - \omega E)^{-1} &= [-(D - \omega E) + (2 - \omega)D](D - \omega E)^{-1} \\ &= -I + (2 - \omega)D(D - \omega E)^{-1},\end{aligned}$$

f_ω can be rewritten as

$$f_\omega = \omega(2 - \omega) (D - \omega F)^{-1}D(D - \omega E)^{-1}b.$$

4.1.1 BLOCK RELAXATION SCHEMES

Block relaxation schemes are generalizations of the “point” relaxation schemes described above. They update a whole set of components at each time, typically a subvector of the solution vector, instead of only one component. The matrix A and the right-hand side and solution vectors are partitioned as follows:

$$A = \begin{pmatrix} A_{11} & A_{12} & A_{13} & \cdots & A_{1p} \\ A_{21} & A_{22} & A_{23} & \cdots & A_{2p} \\ A_{31} & A_{32} & A_{33} & \cdots & A_{3p} \\ \vdots & \vdots & \vdots & \ddots & \vdots \\ A_{p1} & A_{p2} & \cdots & \cdots & A_{pp} \end{pmatrix}, \quad x = \begin{pmatrix} \xi_1 \\ \xi_2 \\ \xi_3 \\ \vdots \\ \xi_p \end{pmatrix}, \quad b = \begin{pmatrix} \beta_1 \\ \beta_2 \\ \beta_3 \\ \vdots \\ \beta_p \end{pmatrix}, \quad (4.15)$$

in which the partitionings of b and x into subvectors β_i and ξ_i are identical and compatible with the partitioning of A . Thus, for any vector x partitioned as in (4.15),

$$(Ax)_i = \sum_{j=1}^p A_{ij}\xi_j,$$

in which $(y)_i$ denotes the i -th component of the vector y according to the above partitioning. The diagonal blocks in A are square and assumed nonsingular.

Now define, similarly to the scalar case, the splitting

$$A = D - E - F$$

with

$$D = \begin{pmatrix} A_{11} & & & \\ & A_{22} & & \\ & & \ddots & \\ & & & A_{pp} \end{pmatrix}, \quad (4.16)$$

$$E = - \begin{pmatrix} O & & & \\ A_{21} & O & & \\ \vdots & \vdots & \ddots & \\ A_{p1} & A_{p2} & \cdots & O \end{pmatrix}, \quad F = - \begin{pmatrix} O & A_{12} & \cdots & A_{1p} \\ & O & \cdots & A_{2p} \\ & & \ddots & \vdots \\ & & & O \end{pmatrix}.$$

With these definitions, it is easy to generalize the previous three iterative procedures defined earlier, namely, Jacobi, Gauss-Seidel, and SOR. For example, the block Jacobi iteration is now defined as a technique in which the new subvectors $\xi_i^{(k)}$ are all replaced according to

$$A_{ii}\xi_i^{(k+1)} = ((E + F)x_k)_i + \beta_i$$

or,

$$\xi_i^{(k+1)} = A_{ii}^{-1} ((E + F)x_k)_i + A_{ii}^{-1}\beta_i, \quad i = 1, \dots, p,$$

which leads to the same equation as before,

$$x_{k+1} = D^{-1}(E + F)x_k + D^{-1}b,$$

except that the meanings of D , E , and F have changed to their block analogues.

With finite difference approximations of PDEs, it is standard to block the variables and the matrix by partitioning along whole lines of the mesh. For example, for the two-dimensional mesh illustrated in Figure 2.5, this partitioning is

$$\xi_1 = \begin{pmatrix} u_{11} \\ u_{12} \\ u_{13} \\ u_{14} \\ u_{15} \end{pmatrix}, \quad \xi_2 = \begin{pmatrix} u_{21} \\ u_{22} \\ u_{23} \\ u_{24} \\ u_{25} \end{pmatrix}, \quad \xi_3 = \begin{pmatrix} u_{31} \\ u_{32} \\ u_{33} \\ u_{34} \\ u_{35} \end{pmatrix}.$$

This corresponds to the mesh 2.5 of Chapter 2, whose associated matrix pattern is shown in Figure 2.6. A relaxation can also be defined along the vertical instead of the horizontal lines. Techniques of this type are often known as *line relaxation* techniques.

In addition, a block can also correspond to the unknowns associated with a few consecutive lines in the plane. One such blocking is illustrated in Figure 4.2 for a 6×6 grid. The corresponding matrix with its block structure is shown in Figure 4.3. An important difference between this partitioning and the one corresponding to the single-line partitioning is that now the matrices A_{ii} are block-tridiagonal instead of tridiagonal. As a result, solving linear systems with A_{ii} may be much more expensive. On the other hand, the number of iterations required to achieve convergence often decreases rapidly as the block-size increases.

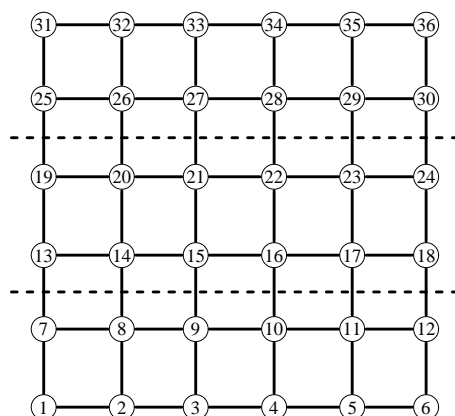

Figure 4.2 Partitioning of a 6×6 square mesh into three subdomains.

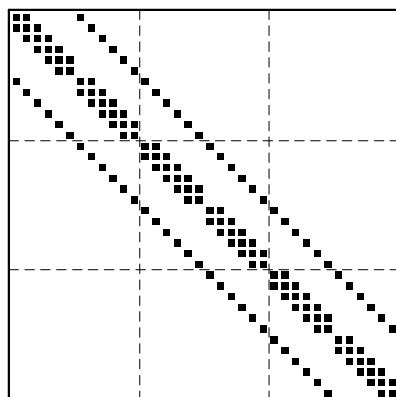

Figure 4.3 Matrix associated with the mesh of Figure 4.2.

Finally, block techniques can be defined in more general terms. First, by using blocks that allow us to update arbitrary groups of components, and second, by allowing the blocks to overlap. Since this is a form of the domain-decomposition method which will be seen later, we define the approach carefully. So far, our partition has been based on an actual *set-partition* of the variable set $S = \{1, 2, \dots, n\}$ into subsets S_1, S_2, \dots, S_p , with the condition that two distinct subsets are disjoint. In set theory, this is called a *partition* of S . More generally, a *set-decomposition* of S removes the constraint of disjointness. In other words it is required that the union of the subsets S_i 's be equal to S :

$$S_i \subseteq S, \quad \bigcup_{i=1, \dots, p} S_i = S.$$

In the following, n_i denotes the size of S_i and the subset S_i is of the form,

$$S_i = \{m_i(1), m_i(2), \dots, m_i(n_i)\}.$$

A general block Jacobi iteration can be defined as follows. Let V_i be the $n \times n_i$ matrix

$$V_i = [e_{m_i(1)}, e_{m_i(2)}, \dots, e_{m_i(n_i)}]$$

and

$$W_i = [\eta_{m_i(1)} e_{m_i(1)}, \eta_{m_i(2)} e_{m_i(2)}, \dots, \eta_{m_i(n_i)} e_{m_i(n_i)}],$$

where each e_j is the j -th column of the $n \times n$ identity matrix, and $\eta_{m_i(j)}$ represents a weight factor chosen so that

$$W_i^T V_i = I.$$

When there is no overlap, i.e., when the S_i 's form a partition of the whole set $\{1, 2, \dots, n\}$, then define $\eta_{m_i(j)} = 1$.

Let A_{ij} be the $n_i \times n_j$ matrix

$$A_{ij} = W_i^T A V_j$$

and define similarly the partitioned vectors

$$\xi_i = W_i^T x, \quad \beta_i = W_i^T b.$$

Note that $V_i W_i^T$ is a projector from \mathbb{R}^n to the subspace K_i spanned by the columns $m_i(1), \dots, m_i(n_i)$. In addition, we have the relation

$$x = \sum_{i=1}^s V_i \xi_i.$$

The n_i -dimensional vector $W_i^T x$ represents the projection $V_i W_i^T x$ of x with respect to the basis spanned by the columns of V_i . The action of V_i performs the reverse operation. That means $V_i y$ is an extension operation from a vector y in K_i (represented in the basis consisting of the columns of V_i) into a vector $V_i y$ in \mathbb{R}^n . The operator W_i^T is termed a *restriction operator* and V_i is an *prolongation operator*.

Each component of the Jacobi iteration can be obtained by imposing the condition that the projection of the residual in the span of S_i be zero, i.e.,

$$W_i^T \left[b - A \left(V_i W_i^T x_{k+1} + \sum_{j \neq i} V_j W_j^T x_k \right) \right] = 0.$$

Remember that $\xi_j = W_j^T x$, which can be rewritten as

$$\xi_i^{(k+1)} = \xi_i^{(k)} + A_{ii}^{-1} W_i^T (b - A x_k). \quad (4.17)$$

This leads to the following algorithm:

ALGORITHM 4.1: General Block Jacobi Iteration

1. For $k = 0, 1, \dots$, until convergence Do:
2. For $i = 1, 2, \dots, p$ Do:
3. Solve $A_{ii} \delta_i = W_i^T (b - A x_k)$
4. Set $x_{k+1} := x_k + V_i \delta_i$
5. EndDo
6. EndDo

As was the case with the scalar algorithms, there is only a slight difference between the Jacobi and Gauss-Seidel iterations. Gauss-Seidel immediately updates the component to be corrected at step i , and uses the updated approximate solution to compute the residual vector needed to correct the next component. However, the Jacobi iteration uses the same previous approximation x_k for this purpose. Therefore, the block Gauss-Seidel iteration can be defined algorithmically as follows:

ALGORITHM 4.2: General Block Gauss-Seidel Iteration

1. *Until convergence Do:*
 2. *For* $i = 1, 2, \dots, p$ *Do:*
 3. *Solve* $A_{ii}\delta_i = W_i^T(b - Ax)$
 4. *Set* $x := x + V_i\delta_i$
 5. *EndDo*
 6. *EndDo*
-

From the point of view of storage, Gauss-Seidel is more economical because the new approximation can be overwritten over the same vector. Also, it typically converges faster. On the other hand, the Jacobi iteration has some appeal on parallel computers since the second *Do* loop, corresponding to the p different blocks, can be executed in parallel. Although the point Jacobi algorithm by itself is rarely a successful technique for real-life problems, its block Jacobi variant, when using large enough overlapping blocks, can be quite attractive especially in a parallel computing environment.

4.1.2 ITERATION MATRICES AND PRECONDITIONING

The Jacobi and Gauss-Seidel iterations are of the form

$$x_{k+1} = Gx_k + f, \quad (4.18)$$

in which

$$G_{JA}(A) = I - D^{-1}A, \quad (4.19)$$

$$G_{GS}(A) = I - (D - E)^{-1}A, \quad (4.20)$$

for the Jacobi and Gauss-Seidel iterations, respectively. Moreover, given the matrix splitting

$$A = M - N, \quad (4.21)$$

where A is associated with the linear system (4.1), a *linear fixed-point iteration* can be defined by the recurrence

$$x_{k+1} = M^{-1}Nx_k + M^{-1}b, \quad (4.22)$$

which has the form (4.18) with

$$G = M^{-1}N = M^{-1}(M - A) = I - M^{-1}A, \quad f = M^{-1}b. \quad (4.23)$$

For example, for the Jacobi iteration, $M = D$, $N = A - D$, while for the Gauss-Seidel iteration, $M = D - E$, $N = M - A = F$.

The iteration $x_{k+1} = Gx_k + f$ can be viewed as a technique for solving the system

$$(I - G)x = f.$$

Since G has the form $G = I - M^{-1}A$, this system can be rewritten as

$$M^{-1}Ax = M^{-1}b.$$

The above system which has the same solution as the original system is called a *preconditioned system* and M is the *preconditioning matrix* or *preconditioner*. In other words, a *relaxation scheme is equivalent to a fixed-point iteration on a preconditioned system*.

For example, for the Jacobi, Gauss-Seidel, SOR, and SSOR iterations, these preconditioning matrices are, respectively,

$$M_{JA} = D, \quad (4.24)$$

$$M_{GS} = D - E, \quad (4.25)$$

$$M_{SOR} = \frac{1}{\omega}(D - \omega E), \quad (4.26)$$

$$M_{SSOR} = \frac{1}{\omega(2 - \omega)}(D - \omega E)D^{-1}(D - \omega F). \quad (4.27)$$

Thus, the Jacobi preconditioner is simply the diagonal of A , while the Gauss-Seidel preconditioner is the lower triangular part of A . The constant coefficients in front of the matrices M_{SOR} and M_{SSOR} only have the effect of scaling the equations of the preconditioned system uniformly. Therefore, they are unimportant in the preconditioning context.

Note that the “preconditioned” system may be a full system. Indeed, there is no reason why M^{-1} should be a sparse matrix (even though M may be sparse), since the inverse of a sparse matrix is not necessarily sparse. This limits the number of techniques that can be applied to solve the preconditioned system. Most of the iterative techniques used only require matrix-by-vector products. In this case, to compute $w = M^{-1}Av$ for a given vector v , first compute $r = Av$ and then solve the system $Mw = r$:

$$\begin{aligned} r &= Av, \\ w &= M^{-1}r. \end{aligned}$$

In some cases, it may be advantageous to exploit the splitting $A = M - N$ and compute $w = M^{-1}Av$ as $w = (I - M^{-1}N)v$ by the procedure

$$\begin{aligned} r &= Nv, \\ w &= M^{-1}r, \\ w &:= v - w. \end{aligned}$$

The matrix N may be sparser than A and the matrix-by-vector product Nv may be less expensive than the product Av . A number of similar but somewhat more complex ideas have been exploited in the context of preconditioned iterative methods. A few of these will be examined in Chapter 9.

CONVERGENCE

4.2

All the methods seen in the previous section define a sequence of iterates of the form

$$x_{k+1} = Gx_k + f, \quad (4.28)$$

in which G is a certain *iteration matrix*. The questions addressed in this section are: (a) if the iteration converges, then is the limit indeed a solution of the original system? (b) under which conditions does the iteration converge? (c) when the iteration does converge, how fast is it?

If the above iteration converges, its limit x satisfies

$$x = Gx + f. \quad (4.29)$$

In the case where the above iteration arises from the splitting $A = M - N$, it is easy to see that the solution x to the above system is identical to that of the original system $Ax = b$. Indeed, in this case the sequence (4.28) has the form

$$x_{k+1} = M^{-1}Nx_k + M^{-1}b$$

and its limit satisfies

$$Mx = Nx + b,$$

or $Ax = b$. This answers question (a). Next, we focus on the other two questions.

4.2.1 GENERAL CONVERGENCE RESULT

If $I - G$ is nonsingular then there is a solution x_* to the equation (4.29). Subtracting (4.29) from (4.28) yields

$$x_{k+1} - x_* = G(x_k - x_*) = \cdots = G^{k+1}(x_0 - x_*). \quad (4.30)$$

Standard results seen in Chapter 1 imply that if the spectral radius of the iteration matrix G is less than unity, then $x_k - x_*$ converges to zero and the iteration (4.28) converges toward the solution defined by (4.29). Conversely, the relation

$$x_{k+1} - x_k = G(x_k - x_{k-1}) = \cdots = G^k(f - (I - G)x_0).$$

shows that if the iteration converges for any x_0 and f then $G^k v$ converges to zero for any vector v . As a result, $\rho(G)$ must be less than unity and the following theorem is proved:

THEOREM 4.1 *Let G be a square matrix such that $\rho(G) < 1$. Then $I - G$ is nonsingular and the iteration (4.28) converges for any f and x_0 . Conversely, if the iteration (4.28) converges for any f and x_0 , then $\rho(G) < 1$.*

Since it is expensive to compute the spectral radius of a matrix, sufficient conditions that guarantee convergence can be useful in practice. One such sufficient condition could be obtained by utilizing the inequality, $\rho(G) \leq \|G\|$, for any matrix norm.

COROLLARY 4.1 Let G be a square matrix such that $\|G\| < 1$ for some matrix norm $\|\cdot\|$. Then $I - G$ is nonsingular and the iteration (4.28) converges for any initial vector x_0 .

Apart from knowing that the sequence (4.28) converges, it is also desirable to know how fast it converges. The error $d_k = x_k - x_*$ at step k satisfies

$$d_k = G^k d_0.$$

The matrix G can be expressed in the Jordan canonical form as $G = X J X^{-1}$. Assume for simplicity that there is only one eigenvalue of G of largest modulus and call it λ . Then

$$d_k = \lambda^k X \left(\frac{J}{\lambda} \right)^k X^{-1} d_0.$$

A careful look at the powers of the matrix J/λ shows that all its blocks, except the block associated with the eigenvalue λ , converge to zero as k tends to infinity. Let this Jordan block be of size p and of the form

$$J_\lambda = \lambda I + E,$$

where E is nilpotent of index p , i.e., $E^p = 0$. Then, for $k \geq p$,

$$J_\lambda^k = (\lambda I + E)^k = \lambda^k (I + \lambda^{-1} E)^k = \lambda^k \left(\sum_{i=0}^{p-1} \lambda^{-i} \binom{k}{i} E^i \right).$$

If k is large enough, then for any λ the dominant term in the above sum is the last term, i.e.,

$$J_\lambda^k \approx \lambda^{k-p+1} \binom{k}{p-1} E^{p-1}.$$

Thus, the norm of $d_k = G^k d_0$ has the asymptotical form

$$\|d_k\| \approx C \times |\lambda^{k-p+1}| \binom{k}{p-1},$$

where C is some constant. The *convergence factor* of a sequence is the limit

$$\rho = \lim_{k \rightarrow \infty} \left(\frac{\|d_k\|}{\|d_0\|} \right)^{1/k}.$$

It follows from the above analysis that $\rho = \rho(G)$. The *convergence rate* τ is the (natural) logarithm of the inverse of the convergence factor

$$\tau = -\ln \rho.$$

The above definition depends on the initial vector x_0 , so it may be termed a *specific* convergence factor. A *general* convergence factor can also be defined by

$$\phi = \lim_{k \rightarrow \infty} \left(\max_{x_0 \in \mathbb{R}^n} \frac{\|d_k\|}{\|d_0\|} \right)^{1/k}.$$

This factor satisfies

$$\begin{aligned}\phi &= \lim_{k \rightarrow \infty} \left(\max_{d_0 \in \mathbb{R}^n} \frac{\|G^k d_0\|}{\|d_0\|} \right)^{1/k} \\ &= \lim_{k \rightarrow \infty} (\|G^k\|)^{1/k} = \rho(G).\end{aligned}$$

Thus, the global asymptotic convergence factor is equal to the spectral radius of the iteration matrix G . The *general* convergence rate differs from the *specific* rate only when the initial error does not have any components in the invariant subspace associated with the dominant eigenvalue. Since it is hard to know this information in advance, the *general* convergence factor is more useful in practice.

Example 4.1 Consider the simple example of *Richardson's Iteration*,

$$x_{k+1} = x_k + \alpha (b - Ax_k), \quad (4.31)$$

where α is a nonnegative scalar. This iteration can be rewritten as

$$x_{k+1} = (I - \alpha A)x_k + \alpha b. \quad (4.32)$$

Thus, the iteration matrix is $G_\alpha = I - \alpha A$ and the convergence factor is $\rho(I - \alpha A)$. Assume that the eigenvalues $\lambda_i, i = 1, \dots, n$, are all real and such that,

$$\lambda_{min} \leq \lambda_i \leq \lambda_{max}.$$

Then, the eigenvalues μ_i of G_α are such that

$$1 - \alpha\lambda_{max} \leq \mu_i \leq 1 - \alpha\lambda_{min}.$$

In particular, if $\lambda_{min} < 0$ and $\lambda_{max} > 0$, at least one eigenvalue is > 1 , and so $\rho(G_\alpha) > 1$ for any α . In this case the method will always diverge for some initial guess. Let us assume that all eigenvalues are positive, i.e., $\lambda_{min} > 0$. Then, the following conditions must be satisfied in order for the method to converge:

$$\begin{aligned}1 - \alpha\lambda_{min} &< 1, \\ 1 - \alpha\lambda_{max} &> -1.\end{aligned}$$

The first condition implies that $\alpha > 0$, while the second requires that $\alpha \leq 2/\lambda_{max}$. In other words, the method converges for any scalar α which satisfies

$$0 < \alpha < \frac{2}{\lambda_{max}}.$$

The next question is: What is the best value α_{opt} for the parameter α , i.e., the value of α which minimizes $\rho(G_\alpha)$? The spectral radius of G_α is

$$\rho(G_\alpha) = \max\{|1 - \alpha\lambda_{min}|, |1 - \alpha\lambda_{max}|\}.$$

This function of α is depicted in Figure 4.4. As the curve shows, the best possible α is reached at the point where the curve $|1 - \lambda_{max}\alpha|$ with positive slope crosses the curve $|1 - \lambda_{min}\alpha|$ with negative slope, i.e., when

$$-1 + \lambda_{max}\alpha = 1 - \lambda_{min}\alpha.$$

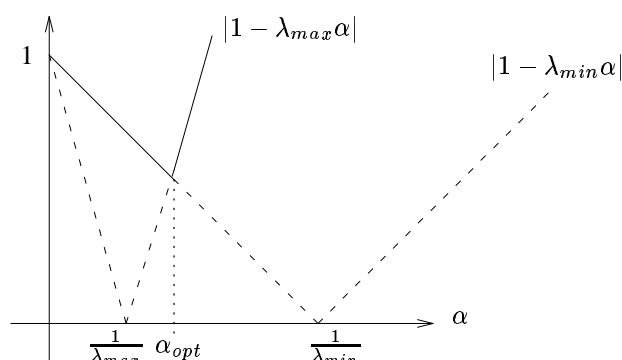

Figure 4.4 The curve $\rho(G_\alpha)$ as a function of α .

This gives

$$\alpha_{opt} = \frac{2}{\lambda_{min} + \lambda_{max}}. \quad (4.33)$$

Replacing this in one of the two curves gives the corresponding optimal spectral radius

$$\rho_{opt} = \frac{\lambda_{max} - \lambda_{min}}{\lambda_{max} + \lambda_{min}}.$$

This expression shows the difficulty with the presence of small and large eigenvalues. The convergence rate can be extremely small for realistic problems. In addition, to achieve good convergence, eigenvalue estimates are required in order to obtain the optimal or a near-optimal α , and this may cause difficulties. Finally, since λ_{max} can be very large, the curve $\rho(G_\alpha)$ can be extremely sensitive near the optimal value of α . These observations are common to many iterative methods that depend on an acceleration parameter.

4.2.2 REGULAR SPLITTINGS

DEFINITION 4.1 Let A, M, N be three given matrices satisfying $A = M - N$. The pair of matrices M, N is a regular splitting of A , if M is nonsingular and M^{-1} and N are nonnegative.

With a regular splitting, we associate the iteration

$$x_{k+1} = M^{-1}N x_k + M^{-1}b. \quad (4.34)$$

The question asked is: Under which conditions does such an iteration converge? The following result, which generalizes Theorem 1.15, gives the answer.

THEOREM 4.2 Let M, N be a regular splitting of a matrix A . Then $\rho(M^{-1}N) < 1$ if and only if A is nonsingular and A^{-1} is nonnegative.

Proof. Define $G = M^{-1}N$. From the fact that $\rho(G) < 1$, and the relation

$$A = M(I - G) \quad (4.35)$$

it follows that A is nonsingular. The assumptions of Theorem 1.15 are satisfied for the matrix G since $G = M^{-1}N$ is nonnegative and $\rho(G) < 1$. Therefore, $(I - G)^{-1}$ is nonnegative as is $A^{-1} = (I - G)^{-1}M^{-1}$.

To prove the sufficient condition, assume that A is nonsingular and that its inverse is nonnegative. Since A and M are nonsingular, the relation (4.35) shows again that $I - G$ is nonsingular and in addition,

$$\begin{aligned} A^{-1}N &= (M(I - M^{-1}N))^{-1}N \\ &= (I - M^{-1}N)^{-1}M^{-1}N \\ &= (I - G)^{-1}G. \end{aligned} \quad (4.36)$$

Clearly, $G = M^{-1}N$ is nonnegative by the assumptions, and as a result of the Perron-Frobenius theorem, there is a nonnegative eigenvector x associated with $\rho(G)$ which is an eigenvalue, such that

$$Gx = \rho(G)x.$$

From this and by virtue of (4.36), it follows that

$$A^{-1}Nx = \frac{\rho(G)}{1 - \rho(G)}x.$$

Since x and $A^{-1}N$ are nonnegative, this shows that

$$\frac{\rho(G)}{1 - \rho(G)} \geq 0$$

and this can be true only when $0 \leq \rho(G) \leq 1$. Since $I - G$ is nonsingular, then $\rho(G) \neq 1$, which implies that $\rho(G) < 1$. ■

This theorem establishes that the iteration (4.34) always converges, if M, N is a regular splitting and A is an M-matrix.

4.2.3 DIAGONALLY DOMINANT MATRICES

We begin with a few standard definitions.

DEFINITION 4.2 A matrix A is

- (weakly) diagonally dominant if

$$|a_{jj}| \geq \sum_{\substack{i=1 \\ i \neq j}}^{i=n} |a_{ij}|, \quad j = 1, \dots, n.$$

- *strictly diagonally dominant if*

$$|a_{jj}| > \sum_{\substack{i=1 \\ i \neq j}}^{i=n} |a_{ij}|, \quad j = 1, \dots, n.$$

- *irreducibly diagonally dominant if A is irreducible, and*

$$|a_{jj}| \geq \sum_{\substack{i=1 \\ i \neq j}}^{i=n} |a_{ij}|, \quad j = 1, \dots, n.$$

with strict inequality for at least one j .

Often the term diagonally dominant is used instead of *weakly* diagonally dominant.

Diagonal dominance is related to an important result in Numerical Linear Algebra known as Gershgorin's theorem. This theorem allows rough locations for all the eigenvalues of A to be determined. In some situations, it is desirable to determine these locations in the complex plane by directly exploiting some knowledge of the entries of the matrix A . The simplest such result is the bound

$$|\lambda_i| \leq \|A\|$$

for any matrix norm. Gershgorin's theorem provides a more precise localization result.

THEOREM 4.3 (Gershgorin) *Any eigenvalue λ of a matrix A is located in one of the closed discs of the complex plane centered at a_{ii} and having the radius*

$$\rho_i = \sum_{\substack{j=1 \\ j \neq i}}^{j=n} |a_{ij}|.$$

In other words,

$$\forall \lambda \in \sigma(A), \quad \exists i \quad \text{such that} \quad |\lambda - a_{ii}| \leq \sum_{\substack{j=1 \\ j \neq i}}^{j=n} |a_{ij}|. \quad (4.37)$$

Proof. Let x be an eigenvector associated with an eigenvalue λ , and let m be the index of the component of largest modulus in x . Scale x so that $|\xi_m| = 1$, and $|\xi_i| \leq 1$, for $i \neq m$. Since x is an eigenvector, then

$$(\lambda - a_{mm})\xi_m = - \sum_{\substack{j=1 \\ j \neq m}}^n a_{mj}\xi_j,$$

which gives

$$|\lambda - a_{mm}| \leq \sum_{\substack{j=1 \\ j \neq m}}^n |a_{mj}||\xi_j| \leq \sum_{\substack{j=1 \\ j \neq m}}^n |a_{mj}| = \rho_m. \quad (4.38)$$

This completes the proof. ■

Since the result also holds for the transpose of A , a version of the theorem can also be formulated based on column sums instead of row sums.

The n discs defined in the theorem are called Gershgorin discs. The theorem states that the union of these n discs contains the spectrum of A . It can also be shown that if there are m Gershgorin discs whose union S is disjoint from all other discs, then S contains exactly m eigenvalues (counted with their multiplicities). For example, when one disc is disjoint from the others, then it must contain exactly one eigenvalue.

An additional refinement which has important consequences concerns the particular case when A is irreducible.

THEOREM 4.4 *Let A be an irreducible matrix, and assume that an eigenvalue λ of A lies on the boundary of the union of the n Gershgorin discs. Then λ lies on the boundary of all Gershgorin discs.*

Proof. As in the proof of Gershgorin's theorem, let x be an eigenvector associated with λ , with $|\xi_m| = 1$, and $|\xi_i| \leq 1$, for $i \neq m$. Start from equation (4.38) in the proof of Gershgorin's theorem which states that the point λ belongs to the m -th disc. In addition, λ belongs to the boundary of the union of all the discs. As a result, it cannot be an interior point to the disc $D(\lambda, \rho_m)$. This implies that $|\lambda - a_{mm}| = \rho_m$. Therefore, the inequalities in (4.38) both become equalities:

$$|\lambda - a_{mm}| = \sum_{\substack{j=1 \\ j \neq m}}^n |a_{mj}| |\xi_j| = \sum_{\substack{j=1 \\ j \neq m}}^n |a_{mj}| = \rho_m. \quad (4.39)$$

Let j be any integer $1 \leq j \leq n$. Since A is irreducible, its graph is connected and, therefore, there exists a path from node m to node j in the adjacency graph. Let this path be

$$m, m_1, m_2, \dots, m_k = j.$$

By definition of an edge in the adjacency graph, $a_{m, m_1} \neq 0$. Because of the equality in (4.39), it is necessary that $|\xi_j| = 1$ for any nonzero ξ_j . Therefore, $|\xi_{m_1}|$ must be equal to one. Now repeating the argument with m replaced by m_1 shows that the following equality holds:

$$|\lambda - a_{m_1, m_1}| = \sum_{\substack{j=1 \\ j \neq m_1}}^n |a_{m_1, j}| |\xi_j| = \sum_{\substack{j=1 \\ j \neq m_1}}^n |a_{m_1, j}| = \rho_{m_1}. \quad (4.40)$$

The argument can be continued showing each time that

$$|\lambda - a_{m_i, m_i}| = \rho_{m_i}, \quad (4.41)$$

and this is valid for $i = 1, \dots, k$. In the end, it will be proved that λ belongs to the boundary of the j -th disc for an arbitrary j . ■

An immediate corollary of the Gershgorin theorem and the above theorem follows.

COROLLARY 4.2 *If a matrix A is strictly diagonally dominant or irreducibly diagonally dominant, then it is nonsingular.*

Proof. If a matrix is strictly diagonally dominant, then the union of the Gershgorin disks excludes the origin, so $\lambda = 0$ cannot be an eigenvalue. Assume now that it is only irreducibly diagonal dominant. Then if it is singular, the zero eigenvalue lies on the boundary of the union of the Gershgorin disks. In this situation, according to the previous theorem, this eigenvalue should lie on the boundary of all the disks. This would mean that

$$|a_{jj}| = \sum_{\substack{i=1 \\ i \neq j}}^n |a_{ij}| \quad \text{for } j = 1, \dots, n,$$

which contradicts the assumption of irreducible diagonal dominance. ■

The following theorem can now be stated.

THEOREM 4.5 *If A is a strictly diagonally dominant or an irreducibly diagonally dominant matrix, then the associated Jacobi and Gauss-Seidel iterations converge for any x_0 .*

Proof. We first prove the results for strictly diagonally dominant matrices. Let λ be the dominant eigenvalue of the iteration matrix $M_J = D^{-1}(E + F)$ for Jacobi and $M_G = (D - E)^{-1}F$ for Gauss-Seidel. As in the proof of Gershgorin's theorem, let x be an eigenvector associated with λ , with $|\xi_m| = 1$, and $|\xi_i| \leq 1$, for $i \neq m$. Start from equation (4.38) in the proof of Gershgorin's theorem which states that for M_J ,

$$|\lambda| \leq \sum_{\substack{j=1 \\ j \neq m}}^n \frac{|a_{mj}|}{|a_{mm}|} |\xi_j| \leq \sum_{\substack{j=1 \\ j \neq m}}^n \frac{|a_{mj}|}{|a_{mm}|} < 1.$$

This proves the result for Jacobi's method.

For the Gauss-Seidel iteration, write the m -th row of the equation $Fx = \lambda(D - E)x$ in the form

$$\sum_{j < m} a_{mj} \xi_j = \lambda \left(a_{mm} \xi_m + \sum_{j > m} a_{mj} \xi_j \right),$$

which yields the inequality

$$|\lambda| \leq \frac{\sum_{j < m} |a_{mj}| |\xi_j|}{|a_{mm}| - \sum_{j > m} |a_{mj}| |\xi_j|} \leq \frac{\sum_{j < m} |a_{mj}|}{|a_{mm}| - \sum_{j > m} |a_{mj}|}.$$

The last term in the above equation has the form $\sigma_2 / (d - \sigma_1)$ with d, σ_1, σ_2 all nonnegative and $d - \sigma_1 - \sigma_2 > 0$. Therefore,

$$|\lambda| \leq \frac{\sigma_2}{\sigma_2 + (d - \sigma_2 - \sigma_1)} < 1.$$

In the case when the matrix is only irreducibly diagonally dominant, the above proofs only show that $\rho(M^{-1}N) \leq 1$, where $M^{-1}N$ is the iteration matrix for either Jacobi or Gauss-Seidel. A proof by contradiction will be used to show that in fact $\rho(M^{-1}N) < 1$. Assume that λ is an eigenvalue of $M^{-1}N$ with $|\lambda| = 1$. Then the matrix $M^{-1}N - \lambda I$ would be singular and, as a result, $A' = N - \lambda M$ would also be singular. Since $|\lambda| = 1$, it is clear that A' is also an irreducibly diagonally dominant matrix. This would contradict Corollary 4.2. ■

4.2.4 SYMMETRIC POSITIVE DEFINITE MATRICES

It is possible to show that when A is Symmetric Positive Definite, then SOR will converge for any ω in the open interval $(0, 2)$ and for any initial guess x_0 . In fact, the reverse is also true under certain assumptions.

THEOREM 4.6 *If A is symmetric with positive diagonal elements and for $0 < \omega < 2$, SOR converges for any x_0 if and only if A is positive definite.*

4.2.5 PROPERTY A AND CONSISTENT ORDERINGS

A number of properties which are related to the graph of a finite difference matrix are now defined. The first of these properties is called Property A. A matrix has Property A if its graph is *bipartite*. This means that the graph is two-colorable in the sense defined in Chapter 3: Its vertices can be partitioned in two sets in such a way that no two vertices in the same set are connected by an edge. Note that, as usual, the self-connecting edges which correspond to the diagonal elements are ignored.

DEFINITION 4.3 *A matrix has Property A if the vertices of its adjacency graph can be partitioned in two sets S_1 and S_2 , so that any edge in the graph links a vertex of S_1 to a vertex of S_2 .*

In other words, nodes from the first set are connected only to nodes from the second set and vice versa. This definition is illustrated in Figure 4.5.

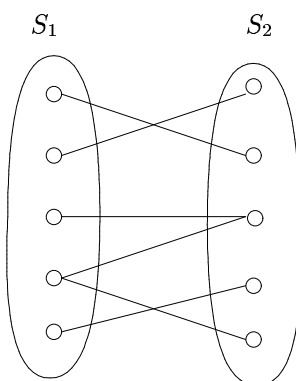

Figure 4.5 *Graph illustration of Property A.*

An alternative definition is that a matrix has Property A if it can be permuted into a matrix with the following structure:

$$A' = \begin{pmatrix} D_1 & -F \\ -E & D_2 \end{pmatrix}, \quad (4.42)$$

where D_1 and D_2 are diagonal matrices. This structure can be obtained by first labeling all the unknowns in S_1 from 1 to n_1 , in which $n_1 = |S_1|$ and the rest from $n_1 + 1$ to n . Note that the Jacobi iteration matrix will have the same structure except that the D_1, D_2 blocks will be replaced by zero blocks. These Jacobi iteration matrices satisfy an important property stated in the following proposition.

PROPOSITION 4.1 *Let B be a matrix with the following structure:*

$$B = \begin{pmatrix} O & B_{12} \\ B_{21} & O \end{pmatrix}, \quad (4.43)$$

and let L and U be the lower and upper triangular parts of B , respectively. Then

1. If μ is an eigenvalue of B , then so is $-\mu$.
2. The eigenvalues of the matrix

$$B(\alpha) = \alpha L + \frac{1}{\alpha} U$$

defined for $\alpha \neq 0$ are independent of α .

Proof. The first property is shown by simply observing that if $\begin{pmatrix} x \\ v \end{pmatrix}$ is an eigenvector associated with μ , then $\begin{pmatrix} x \\ -v \end{pmatrix}$ is an eigenvector of B associated with the eigenvalue $-\mu$.

Consider the second property. For any α , the matrix $B(\alpha)$ is similar to B , i.e., $B(\alpha) = XBX^{-1}$ with X defined by

$$X = \begin{pmatrix} 1 & O \\ O & \alpha \end{pmatrix}.$$

This proves the desired result ■

A definition which generalizes this important property is *consistently ordered matrices*. Varga [213] calls a consistently ordered matrix one for which the eigenvalues of $B(\alpha)$ are independent of α . Another definition given by Young [232] considers a specific class of matrices which generalize this property. We will use this definition here. Unlike Property A, the consistent ordering property depends on the initial ordering of the unknowns.

DEFINITION 4.4 *A matrix is said to be consistently ordered if the vertices of its adjacency graph can be partitioned in p sets S_1, S_2, \dots, S_p with the property that any two adjacent vertices i and j in the graph belong to two consecutive partitions S_k and $S_{k'}$, with $k' = k - 1$, if $j < i$, and $k' = k + 1$, if $j > i$.*

It is easy to show that consistently ordered matrices satisfy property A: the first color is made up of all the partitions S_i with odd i and the second with the partitions S_i with even i .

Example 4.2 Block tridiagonal matrices of the form

$$T = \begin{pmatrix} D_1 & T_{12} & & & \\ T_{21} & D_2 & T_{23} & & \\ & T_{32} & D_3 & \ddots & \\ & & \ddots & \ddots & T_{p-1,p} \\ & & & T_{p,p-1} & D_p \end{pmatrix}$$

whose diagonal blocks D_i are diagonal matrices are called T -matrices. Clearly, such matrices are consistently ordered. Note that matrices of the form (4.42) are a particular case with $p = 2$.

Consider now a general, consistently ordered matrix. By definition, there is permutation π of $\{1, 2, \dots, n\}$ which is the union of p disjoint subsets

$$\pi = \pi_1 \cup \pi_2 \dots \cup \pi_p \tag{4.44}$$

with the property that if $a_{ij} \neq 0$, $j \neq i$ and i belongs to π_k , then j belongs to $\pi_{k\pm 1}$ depending on whether $i < j$ or $i > j$. This permutation π can be used to permute A symmetrically. If P is the permutation matrix associated with the permutation π , then clearly

$$A' = P^T A P$$

is a T -matrix.

Not every matrix that can be symmetrically permuted into a T -matrix is consistently ordered. The important property here is that the partition $\{\pi_i\}$ preserves the order of the indices i, j of nonzero elements. In terms of the adjacency graph, there is a partition of the graph with the property that an oriented edge i, j from i to j always points to a set with a larger index if $j > i$, or a smaller index otherwise. In particular, a very important consequence is that edges corresponding to the lower triangular part will remain so in the permuted matrix. The same is true for the upper triangular part. Indeed, if a nonzero element in the permuted matrix is $a'_{i',j'} = a_{\pi^{-1}(i'),\pi^{-1}(j')} \neq 0$ with $i' > j'$, then by definition of the permutation $\pi(i') > \pi(j')$, or $i = \pi(\pi^{-1}(i')) > j = \pi(\pi^{-1}(j'))$. Because of the order preservation, it is necessary that $i > j$. A similar observation holds for the upper triangular part. Therefore, this results in the following proposition.

PROPOSITION 4.2 *If a matrix A is consistently ordered, then there exists a permutation matrix P such that $P^T A P$ is a T -matrix and*

$$(P^T A P)_L = P^T A_L P, \quad (P^T A P)_U = P^T A_U P \tag{4.45}$$

in which X_L represents the (strict) lower part of X and X_U the (strict) upper part of X .

With the above property it can be shown that for consistently ordered matrices the eigenvalues of $B(\alpha)$ as defined in Proposition 4.1 are also invariant with respect to α .

PROPOSITION 4.3 *Let B be the Jacobi iteration matrix associated with a consistently ordered matrix A , and let L and U be the lower and upper triangular parts of B , respec-*

tively. Then the eigenvalues of the matrix

$$B(\alpha) = \alpha L + \frac{1}{\alpha} U$$

defined for $\alpha \neq 0$ do not depend on α .

Proof. First transform $B(\alpha)$ into a T -matrix using the permutation π in (4.44) provided by the previous proposition

$$P^T B(\alpha) P = \alpha P^T L P + \frac{1}{\alpha} P^T U P.$$

From the previous proposition, the lower part of $P^T B P$ is precisely $L' = P^T L P$. Similarly, the upper part is $U' = P^T U P$, the lower and upper parts of the associated T -matrix. Therefore, we only need to show that the property is true for a T -matrix.

In this case, for any α , the matrix $B(\alpha)$ is similar to B . This means that $B(\alpha) = X B X^{-1}$ with X being equal to

$$X = \begin{pmatrix} 1 & & & & \\ & \alpha I & & & \\ & & \alpha^2 I & & \\ & & & \ddots & \\ & & & & \alpha^{p-1} I \end{pmatrix},$$

where the partitioning is associated with the subsets π_1, \dots, π_p respectively. ■

Note that T -matrices and matrices with the structure (4.42) are two particular cases of matrices which fulfill the assumptions of the above proposition. There are a number of well known properties related to Property A and consistent orderings. For example, it is possible to show that,

- Property A is invariant under symmetric permutations.
- A matrix has Property A if and only if there is a permutation matrix P such that $A' = P^{-1} A P$ is consistently ordered.

Consistently ordered matrices satisfy an important property which relates the eigenvalues of the corresponding SOR iteration matrices to those of the Jacobi iteration matrices. The main theorem regarding the theory for SOR is a consequence of the following result proved by Young [232]. Remember that

$$\begin{aligned} M_{SOR} &= (D - \omega E)^{-1} (\omega F + (1 - \omega) D) \\ &= (I - \omega D^{-1} E)^{-1} (\omega D^{-1} F + (1 - \omega) I). \end{aligned}$$

THEOREM 4.7 *Let A be a consistently ordered matrix such that $a_{ii} \neq 0$ for $i = 1, \dots, n$, and let $\omega \neq 0$. Then if λ is a nonzero eigenvalue of the SOR iteration matrix M_{SOR} , any scalar μ such that*

$$(\lambda + \omega - 1)^2 = \lambda \omega^2 \mu^2 \tag{4.46}$$

is an eigenvalue of the Jacobi iteration matrix B . Conversely, if μ is an eigenvalue of the Jacobi matrix B and if a scalar λ satisfies (4.46), then λ is an eigenvalue of M_{SOR} .

Proof. Denote $D^{-1}E$ by L and $D^{-1}F$ by U , so that

$$M_{SOR} = (I - \omega L)^{-1}(\omega U + (1 - \omega)I)$$

and the Jacobi iteration matrix is merely $L + U$. Writing that λ is an eigenvalue yields

$$\det(\lambda I - (I - \omega L)^{-1}(\omega U + (1 - \omega)I)) = 0$$

which is equivalent to

$$\det(\lambda(I - \omega L) - (\omega U + (1 - \omega)I)) = 0$$

or

$$\det((\lambda + \omega - 1)I - \omega(\lambda L + U)) = 0.$$

Since $\omega \neq 0$, this can be rewritten as

$$\det\left(\frac{\lambda + \omega - 1}{\omega}I - (\lambda L + U)\right) = 0,$$

which means that $(\lambda + \omega - 1)/\omega$ is an eigenvalue of $\lambda L + U$. Since A is consistently ordered, the eigenvalues of $\lambda L + U$ which are equal to $\lambda^{1/2}(\lambda^{1/2}L + \lambda^{-1/2}U)$ are the same as those of $\lambda^{1/2}(L + U)$, where $L + U$ is the Jacobi iteration matrix. The proof follows immediately. ■

This theorem allows us to compute an optimal value for ω , which can be shown to be equal to

$$\omega_{opt} = \frac{2}{1 + \sqrt{1 - \rho(B)^2}}. \quad (4.47)$$

A typical SOR procedure starts with some ω , for example, $\omega = 1$, then proceeds with a number of SOR steps with this ω . The convergence rate for the resulting iterates is estimated providing an estimate for $\rho(B)$ using Theorem 4.7. A better ω is then obtained from the formula (4.47), and the iteration restarted. Further refinements of the optimal ω are calculated and retrofitted in this manner as the algorithm progresses.

ALTERNATING DIRECTION METHODS

4.3

The Alternating Direction Implicit (ADI) method was introduced in the mid-1950s by Peaceman and Rachford [162] specifically for solving equations arising from finite difference discretizations of elliptic and parabolic Partial Differential Equations. Consider a partial differential equation of elliptic type

$$\frac{\partial}{\partial x} \left(a(x, y) \frac{\partial u(x, y)}{\partial x} \right) + \frac{\partial}{\partial y} \left(b(x, y) \frac{\partial u(x, y)}{\partial y} \right) = f(x, y) \quad (4.48)$$

on a rectangular domain with Dirichlet boundary conditions. The equations are discretized with centered finite differences using $n + 2$ points in the x direction and $m + 2$ points in

the y direction, This results in the system of equations

$$Hu + Vu = b, \quad (4.49)$$

in which the matrices H and V represent the three-point central difference approximations to the operators

$$\frac{\partial}{\partial x} \left(a(x, y) \frac{\partial}{\partial x} \right) \quad \text{and} \quad \frac{\partial}{\partial y} \left(b(x, y) \frac{\partial}{\partial y} \right),$$

respectively. In what follows, the same notation is used to represent the discretized version of the unknown function u .

The ADI algorithm consists of iterating by solving (4.49) in the x and y directions alternatively as follows.

ALGORITHM 4.3: Peaceman-Rachford (PR) ADI

1. For $k = 0, 1, \dots$, until convergence Do:
 2. Solve: $(H + \rho_k I)u_{k+\frac{1}{2}} = (\rho_k I - V)u_k + b$
 3. Solve: $(V + \rho_k I)u_{k+1} = (\rho_k I - H)u_{k+\frac{1}{2}} + b$
 4. EndDo
-

Here, $\rho_k, k = 1, 2, \dots$, is a sequence of positive acceleration parameters.

The specific case where ρ_k is chosen to be a constant ρ deserves particular attention. In this case, we can formulate the above iteration in the usual form of (4.28) with

$$G = (V + \rho I)^{-1}(H - \rho I)(H + \rho I)^{-1}(V - \rho I), \quad (4.50)$$

$$f = (V + \rho I)^{-1} [I - (H - \rho I)(H + \rho I)^{-1}] b \quad (4.51)$$

or, when $\rho > 0$, in the form (4.22) with

$$M = \frac{1}{2\rho}(H + \rho I)(V + \rho I), \quad N = \frac{1}{2\rho}(H - \rho I)(V - \rho I). \quad (4.52)$$

Note that (4.51) can be rewritten in a simpler form; see Exercise 5.

The ADI algorithm is often formulated for solving the time-dependent Partial Differential Equation

$$\frac{\partial u}{\partial t} = \frac{\partial}{\partial x} \left(a(x, y) \frac{\partial u}{\partial x} \right) + \frac{\partial}{\partial y} \left(b(x, y) \frac{\partial u}{\partial y} \right) \quad (4.53)$$

on the domain $(x, y, t) \in \Omega \times [0, T] \equiv (0, 1) \times (0, 1) \times [0, T]$. The initial and boundary conditions are:

$$u(x, y, 0) = x_0(x, y), \quad \forall (x, y) \in \Omega, \quad (4.54)$$

$$u(\bar{x}, \bar{y}, t) = g(\bar{x}, \bar{y}, t), \quad \forall (\bar{x}, \bar{y}) \in \partial\Omega, \quad t > 0, \quad (4.55)$$

where $\partial\Omega$ is the boundary of the unit square Ω . The equations are discretized with respect to the space variables x and y as before, resulting in a system of Ordinary Differential Equations:

$$\frac{du}{dt} = Hu + Vu, \quad (4.56)$$

in which the matrices H and V have been defined earlier. The Alternating Direction Implicit algorithm advances the relation (4.56) forward in time alternately in the x and y directions as follows:

$$(I - \frac{1}{2}\Delta t H)u_{k+\frac{1}{2}} = (I + \frac{1}{2}\Delta t V)u_k,$$

$$(I - \frac{1}{2}\Delta t V)u_{k+1} = (I + \frac{1}{2}\Delta t H)u_{k+\frac{1}{2}}.$$

The acceleration parameters ρ_k of Algorithm 4.3 are replaced by a natural time-step.

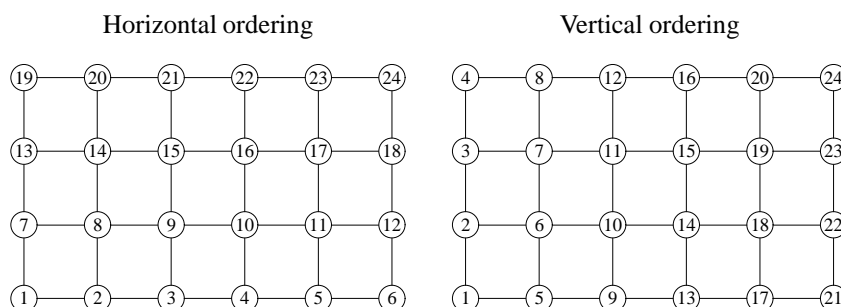

Figure 4.6 The horizontal and vertical orderings for the unknowns in ADI.

Assuming that the mesh-points are ordered by lines in the x -direction, then the first step of Algorithm 4.3 constitutes a set of m independent tridiagonal linear systems of size n each. However, the second step constitutes a large tridiagonal system whose three diagonals are offset by $-m$, 0 , and m , respectively. This second system can also be rewritten as a set of n independent tridiagonal systems of size m each by reordering the grid points by lines, this time in the y direction. The natural (horizontal) and vertical orderings are illustrated in Figure 4.6. Whenever moving from one half step of ADI to the next, we must implicitly work with the transpose of the matrix representing the solution on the $n \times m$ grid points. This data operation may be an expensive task on parallel machines and often it is cited as one of the drawbacks of Alternating Direction Methods in this case.

ADI methods were extensively studied in the 1950s and 1960s for the particular case of positive definite systems. For such systems, H and V have real eigenvalues and the following is a summary of the main results in this situation. First, when H and V are Symmetric Positive Definite, then the stationary iteration ($\rho_k = \rho > 0$, for all k) converges. For the model problem, the asymptotic rate of convergence of the stationary ADI iteration using the optimal ρ is the same as that of SSOR using the optimal ω . However, each ADI step is more expensive than one SSOR step. One of the more important results in the ADI theory is that the rate of convergence of ADI can be increased appreciably by using a cyclic sequence of parameters, ρ_k . A theory for selecting the best sequence of ρ_k 's is well understood in the case when H and V commute [26]. For the model problem, the parameters can be selected so that the time complexity is reduced to $O(n^2 \log n)$, for details see [162].

EXERCISES

1. Consider an $n \times n$ tridiagonal matrix of the form

$$T_\alpha = \begin{pmatrix} \alpha & -1 & & & \\ -1 & \alpha & -1 & & \\ & -1 & \alpha & -1 & \\ & & -1 & \alpha & -1 \\ & & & -1 & \alpha \end{pmatrix}, \quad (4.57)$$

where α is a real parameter.

a. Verify that the eigenvalues of T_α are given by

$$\lambda_j = \alpha - 2 \cos(j\theta) \quad j = 1, \dots, n,$$

where

$$\theta = \frac{\pi}{n+1}$$

and that an eigenvector associated with each λ_j is

$$q_j = [\sin(j\theta), \sin(2j\theta), \dots, \sin(nj\theta)]^T.$$

Under what condition on α does this matrix become positive definite?

b. Now take $\alpha = 2$. How does this matrix relate to the matrices seen in Chapter 2 for one-dimensional problems?

i. Will the Jacobi iteration converge for this matrix? If so, what will its convergence factor be?

ii. Will the Gauss-Seidel iteration converge for this matrix? If so, what will its convergence factor be?

iii. For which values of ω will the SOR iteration converge?

2. Prove that the iteration matrix G_ω of SSOR, as defined by (4.13), can be expressed as

$$G_\omega = I - \omega(2 - \omega)(D - \omega F)^{-1}D(D - \omega E)^{-1}A.$$

Deduce the expression (4.27) for the preconditioning matrix associated with the SSOR iteration.

3. Let A be a matrix with a positive diagonal D .

a. Obtain an expression equivalent to that of (4.13) for G_ω but which involves the matrices $S_E \equiv D^{-1/2}ED^{-1/2}$ and $S_F \equiv D^{-1/2}FD^{-1/2}$.

b. Show that

$$D^{1/2}G_\omega D^{-1/2} = (I - \omega S_F)^{-1}(I - \omega S_E)^{-1}(\omega S_E + (1 - \omega)I)(\omega S_F + (1 - \omega)I)$$

c. Now assume that in addition to having a positive diagonal, A is symmetric. Prove that the eigenvalues of the SSOR iteration matrix G_ω are real and nonnegative.

4. Let

$$A = \begin{pmatrix} D_1 & -F_2 & & & \\ -E_2 & D_2 & -F_3 & & \\ & -E_3 & D_3 & \ddots & \\ & & & \ddots & -F_m \\ & & & -E_m & D_m \end{pmatrix},$$

where the D_i blocks are nonsingular matrices which are not necessarily diagonal.

- What are the *block Jacobi* and *block Gauss-Seidel* iteration matrices?
 - Show a result similar to that in Proposition 4.3 for the Jacobi iteration matrix.
 - Show also that for $\omega = 1$ (1) the block Gauss-Seidel and block Jacobi iterations either both converge or both diverge, and (2) when they both converge, then the block Gauss-Seidel iteration is (asymptotically) twice as fast as the block Jacobi iteration.
5. According to formula (4.23), the f vector in iteration (4.22) should be equal to $M^{-1}b$, where b is the right-hand side and M is given in (4.52). Yet, formula (4.51) gives a different expression for f . Reconcile the two results, i.e., show that the expression (4.51) can also be rewritten as

$$f = 2\rho(V + \rho I)^{-1}(H + \rho I)^{-1}b.$$

- Show that a matrix has Property A if and only if there is a permutation matrix P such that $A' = P^{-1}AP$ is consistently ordered.
- Consider a matrix A which is consistently ordered. Show that the asymptotic convergence rate for Gauss-Seidel is double that of the Jacobi iteration.
- A matrix of the form

$$B = \begin{pmatrix} 0 & E & 0 \\ 0 & 0 & F \\ H & 0 & 0 \end{pmatrix}$$

is called a three-cyclic matrix.

- What are the eigenvalues of B ? (Express them in terms of eigenvalues of a certain matrix which depends on E , F , and H .)
- Assume that a matrix A has the form $A = D + B$, where D is a nonsingular diagonal matrix, and B is three-cyclic. How can the eigenvalues of the Jacobi iteration matrix be related to those of the Gauss-Seidel iteration matrix? How does the asymptotic convergence rate of the Gauss-Seidel iteration compare with that of the Jacobi iteration matrix in this case?
- Answer the same questions as in (2) for the case when SOR replaces the Gauss-Seidel iteration.
- Generalize the above results to p -cyclic matrices, i.e., matrices of the form

$$B = \begin{pmatrix} 0 & E_1 & & & \\ & 0 & E_2 & & \\ & & 0 & \ddots & \\ & & & 0 & E_{p-1} \\ E_p & & & & 0 \end{pmatrix}.$$

NOTES AND REFERENCES. Two good references for the material covered in this chapter are Varga [213] and Young [232]. Although relaxation-type methods were very popular up to the 1960s, they are now mostly used as preconditioners, a topic which will be seen in detail in Chapters 9 and 10. One of the main difficulties with these methods is finding an optimal relaxation factor for

general matrices. Theorem 4.4 is due to Ostrowski. For details on the use of Gershgorin's theorem in eigenvalue problems, see [180]. The original idea of the ADI method is described in [162] and those results on the optimal parameters for ADI can be found in [26]. A comprehensive text on this class of techniques can be found in [220]. Not covered in this book is the related class of multigrid methods; see the reference [115] for a detailed exposition. Closely related to the multigrid approach is the Aggregation-Disaggregation technique which is popular in Markov chain modeling. A recommended book for these methods and others used in the context of Markov chain modeling is [203]. ■

PROJECTION METHODS

Most of the existing practical iterative techniques for solving large linear systems of equations utilize a projection process in one way or another. A projection process represents a *canonical* way for extracting an approximation to the solution of a linear system from a subspace. This chapter describes these techniques in a very general framework and presents some theory. The one-dimensional case is covered in detail at the end of the chapter, as it provides a good preview of the more complex projection processes to be seen in later chapters.

BASIC DEFINITIONS AND ALGORITHMS

5.1

Consider the linear system

$$Ax = b, \quad (5.1)$$

where A is an $n \times n$ real matrix. In this chapter, the same symbol A is often used to denote the matrix and the linear mapping in \mathbb{R}^n that it represents. The idea of *projection techniques* is to extract an approximate solution to the above problem from a subspace of \mathbb{R}^n . If \mathcal{K} is this subspace of *candidate approximants*, or *search subspace*, and if m is its dimension, then, in general, m constraints must be imposed to be able to extract such an approximation. A typical way of describing these constraints is to impose m (independent) orthogonality conditions. Specifically, the residual vector $b - Ax$ is constrained to be orthogonal to m linearly independent vectors. This defines another subspace \mathcal{L} of dimension m which will be called the *subspace of constraints* or *left subspace* for reasons that will be explained below. This simple framework is common to many different mathematical methods and is known as the Petrov-Galerkin conditions.

There are two broad classes of projection methods: *orthogonal* and *oblique*. In an orthogonal projection technique, the subspace \mathcal{L} is the same as \mathcal{K} . In an oblique projection

method, \mathcal{L} is different from \mathcal{K} and may be totally unrelated to it. This distinction is rather important and gives rise to different types of algorithms.

5.1.1 GENERAL PROJECTION METHODS

Let A be an $n \times n$ real matrix and \mathcal{K} and \mathcal{L} be two m -dimensional subspaces of \mathbb{R}^n . A projection technique onto the subspace \mathcal{K} and orthogonal to \mathcal{L} is a process which finds an approximate solution \tilde{x} to (5.1) by imposing the conditions that \tilde{x} belong to \mathcal{K} and that the new residual vector be orthogonal to \mathcal{L} ,

$$\text{Find } \tilde{x} \in \mathcal{K}, \quad \text{such that } b - A\tilde{x} \perp \mathcal{L}. \quad (5.2)$$

If we wish to exploit the knowledge of an initial guess x_0 to the solution, then the approximation must be sought in the affine space $x_0 + \mathcal{K}$ instead of the homogeneous vector space \mathcal{K} . This requires a slight modification to the above formulation. The approximate problem should be redefined as

$$\text{Find } \tilde{x} \in x_0 + \mathcal{K}, \quad \text{such that } b - A\tilde{x} \perp \mathcal{L}. \quad (5.3)$$

Note that if \tilde{x} is written in the form $\tilde{x} = x_0 + \delta$, and the initial residual vector r_0 is defined as

$$r_0 = b - Ax_0, \quad (5.4)$$

then the above equation becomes $b - A(x_0 + \delta) \perp \mathcal{L}$ or

$$r_0 - A\delta \perp \mathcal{L}.$$

In other words, the approximate solution can be defined as

$$\tilde{x} = x_0 + \delta, \quad \delta \in \mathcal{K}, \quad (5.5)$$

$$(r_0 - A\delta, w) = 0, \quad \forall w \in \mathcal{L}. \quad (5.6)$$

The orthogonality condition (5.6) imposed on the new residual $r_{new} = r_0 - A\delta$ is illustrated in Figure 5.1.

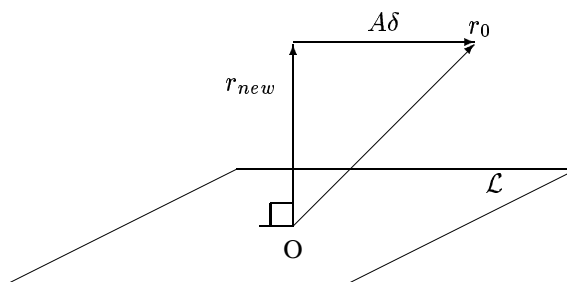

Figure 5.1 Interpretation of the orthogonality condition.

This is a basic projection step, in its most general form. Most standard techniques use a succession of such projections. Typically, a new projection step uses a new pair of subspace \mathcal{K} and \mathcal{L} and an initial guess x_0 equal to the most recent approximation obtained

from the previous projection step. Projection methods form a unifying framework for many of the well known methods in scientific computing. In fact, virtually all of the basic iterative techniques seen in the previous chapter can be considered projection techniques. Whenever an approximation is defined via m degrees of freedom (subspace \mathcal{K}) and m constraints (Subspace \mathcal{L}), a projection process results.

Example 5.1 In the simplest case, an elementary Gauss-Seidel step as defined by (4.6) is nothing but a projection step with $\mathcal{K} = \mathcal{L} = \text{span}\{e_i\}$. These projection steps are cycled for $i = 1, \dots, n$ until convergence. See Exercise 1 for an alternative way of selecting the sequence of e_i 's.

Orthogonal projection methods correspond to the particular case when the two subspaces \mathcal{L} and \mathcal{K} are identical. The distinction is particularly important in the Hermitian case since we are guaranteed that the projected problem will be Hermitian in this situation, as will be seen shortly. In addition, a number of helpful theoretical results are true for the orthogonal case. When $\mathcal{L} = \mathcal{K}$, the Petrov-Galerkin conditions are called the Galerkin conditions.

5.1.2 MATRIX REPRESENTATION

Let $V = [v_1, \dots, v_m]$, an $n \times m$ matrix whose column-vectors form a basis of \mathcal{K} and, similarly, $W = [w_1, \dots, w_m]$, an $n \times m$ matrix whose column-vectors form a basis of \mathcal{L} . If the approximate solution is written as

$$x = x_0 + Vy,$$

then the orthogonality condition leads immediately to the following system of equations for the vector y :

$$W^T AVy = W^T r_0.$$

If the assumption is made that the $m \times m$ matrix $W^T AV$ is nonsingular, the following expression for the approximate solution \tilde{x} results,

$$\tilde{x} = x_0 + V(W^T AV)^{-1}W^T r_0. \quad (5.7)$$

In many algorithms, the matrix $W^T AV$ does not have to be formed since it is available as a by-product of the algorithm. A prototype projection technique is represented by the following algorithm.

ALGORITHM 5.1: Prototype Projection Method

1. *Until convergence, Do:*
2. Select a pair of subspaces \mathcal{K} and \mathcal{L}
3. Choose bases $V = [v_1, \dots, v_m]$ and $W = [w_1, \dots, w_m]$ for \mathcal{K} and \mathcal{L}
4. $r := b - Ax$
5. $y := (W^T AV)^{-1} W^T r$
6. $x := x + Vy$
7. *EndDo*

The approximate solution is defined only when the matrix $W^T AV$ is nonsingular, which is not guaranteed to be true even when A is nonsingular.

Example 5.2 As an example, consider the matrix

$$A = \begin{pmatrix} O & I \\ I & I \end{pmatrix},$$

where I is the $m \times m$ identity matrix and O is the $m \times m$ zero matrix, and let $V = W = [e_1, e_2, \dots, e_m]$. Although A is nonsingular, the matrix $W^T AV$ is precisely the O block in the upper-left corner of A and is therefore singular.

There are two important particular cases where the nonsingularity of $W^T AV$ is guaranteed. These are discussed in the following proposition.

PROPOSITION 5.1 Let A , \mathcal{L} , and \mathcal{K} satisfy either one of the two following conditions,

- i. A is positive definite and $\mathcal{L} = \mathcal{K}$, or
- ii. A is nonsingular and $\mathcal{L} = AK$.

Then the matrix $B = W^T AV$ is nonsingular for any bases V and W of \mathcal{K} and \mathcal{L} , respectively.

Proof. Consider first the case (i). Let V be any basis of \mathcal{K} and W be any basis of \mathcal{L} . In fact, since \mathcal{L} and \mathcal{K} are the same, W can always be expressed as $W = VG$, where G is a nonsingular $m \times m$ matrix. Then

$$B = W^T AV = G^T V^T AV.$$

Since A is positive definite, so is $V^T AV$, see Chapter 1, and this shows that B is nonsingular.

Consider now case (ii). Let V be any basis of \mathcal{K} and W be any basis of \mathcal{L} . Since $\mathcal{L} = AK$, W can be expressed in this case as $W = AVG$, where G is a nonsingular $m \times m$ matrix. Then

$$B = W^T AV = G^T (AV)^T AV. \quad (5.8)$$

Since A is nonsingular, the $n \times m$ matrix AV is of full rank and as a result, $(AV)^T AV$ is nonsingular. This, along with (5.8), shows that B is nonsingular. ■

Now consider the particular case where A is symmetric (real) and an orthogonal projection technique is used. In this situation, the same basis can be used for \mathcal{L} and \mathcal{K} , which are identical subspaces, and the projected matrix, which is $B = V^T AV$, is symmetric. In addition, if the matrix A is Symmetric Positive Definite, then so is B .

GENERAL THEORY

5.2

This section gives some general theoretical results without being specific about the subspaces \mathcal{K} and \mathcal{L} which are used. The goal is to learn about the quality of the approximation obtained from a general projection process. Two main tools are used for this. The first is to exploit optimality properties of projection methods. These properties are induced from those properties of projectors seen in Section 1.12.4 of Chapter 1. The second tool consists of interpreting the projected problem with the help of projection operators in an attempt to extract residual bounds.

5.2.1 TWO OPTIMALITY RESULTS

In this section, two important optimality results will be established that are satisfied by the approximate solutions in some cases. Consider first the case when A is SPD.

PROPOSITION 5.2 *Assume that A is Symmetric Positive Definite and $\mathcal{L} = \mathcal{K}$. Then a vector \tilde{x} is the result of an (orthogonal) projection method onto \mathcal{K} with the starting vector x_0 if and only if it minimizes the A -norm of the error over $x_0 + \mathcal{K}$, i.e., if and only if*

$$E(\tilde{x}) = \min_{x \in x_0 + \mathcal{K}} E(x),$$

where

$$E(x) \equiv (A(x_* - x), x_* - x)^{1/2}.$$

Proof. As was seen in Section 1.12.4, for \tilde{x} to be the minimizer of $E(x)$, it is necessary and sufficient that $x_* - \tilde{x}$ be A -orthogonal to all the subspace \mathcal{K} . This yields

$$(A(x_* - \tilde{x}), v) = 0, \quad \forall v \in \mathcal{K},$$

or, equivalently,

$$(b - A\tilde{x}, v) = 0, \quad \forall v \in \mathcal{K},$$

which is the Galerkin condition defining an orthogonal projection process for the approximation \tilde{x} . ■

We now take up the case when \mathcal{L} is defined by $\mathcal{L} = A\mathcal{K}$.

PROPOSITION 5.3 *Let A be an arbitrary square matrix and assume that $\mathcal{L} = A\mathcal{K}$. Then a vector \tilde{x} is the result of an (oblique) projection method onto \mathcal{K} orthogonally to \mathcal{L} with the starting vector x_0 if and only if it minimizes the 2-norm of the residual vector $b - Ax$ over $x \in x_0 + \mathcal{K}$, i.e., if and only if*

$$R(\tilde{x}) = \min_{x \in x_0 + \mathcal{K}} R(x),$$

where $R(x) \equiv \|b - Ax\|_2$.

Proof. As was seen in Section 1.12.4, for \tilde{x} to be the minimizer of $R(x)$, it is necessary and sufficient that $b - A\tilde{x}$ be orthogonal to all vectors of the form $v = Ay$, where y belongs to \mathcal{K} , i.e.,

$$(b - A\tilde{x}, v) = 0, \quad \forall v \in A\mathcal{K},$$

which is precisely the Petrov-Galerkin condition that defines the approximate solution \tilde{x} . ■

It is worthwhile to point out that A need not be nonsingular in the above proposition. When A is singular there may be infinitely many vectors \tilde{x} satisfying the optimality condition.

5.2.2 INTERPRETATION IN TERMS OF PROJECTORS

We now return to the two important particular cases singled out in the previous section, namely, the cases $\mathcal{L} = \mathcal{K}$ and $\mathcal{L} = A\mathcal{K}$. In these cases, the result of the projection process can be interpreted easily in terms of actions of orthogonal projectors on the initial residual or initial error. Consider the second case first, as it is slightly simpler. Let r_0 be the initial residual $r_0 = b - Ax_0$, and $\tilde{r} = b - A\tilde{x}$ the residual obtained after the projection process with $\mathcal{L} = A\mathcal{K}$. Then,

$$\tilde{r} = b - A(x_0 + \delta) = r_0 - A\delta. \quad (5.9)$$

In addition, δ is obtained by enforcing the condition that $r_0 - A\delta$ be orthogonal to $A\mathcal{K}$. Therefore, the vector $A\delta$ is *the orthogonal projection of the vector r_0 onto the subspace $A\mathcal{K}$* . This is illustrated in Figure 5.2. Hence, the following proposition can be stated.

PROPOSITION 5.4 *Let \tilde{x} be the approximate solution obtained from a projection process onto \mathcal{K} orthogonally to $\mathcal{L} = A\mathcal{K}$, and let $\tilde{r} = b - A\tilde{x}$ be the associated residual. Then,*

$$\tilde{r} = (I - P)r_0, \quad (5.10)$$

where P denotes the orthogonal projector onto the subspace $A\mathcal{K}$.

A result of the proposition is that the 2-norm of the residual vector obtained after one projection step will not exceed the initial 2-norm of the residual, i.e.,

$$\|\tilde{r}\|_2 \leq \|r_0\|_2,$$

a result which has been established already. This class of methods may be termed *residual projection* methods.

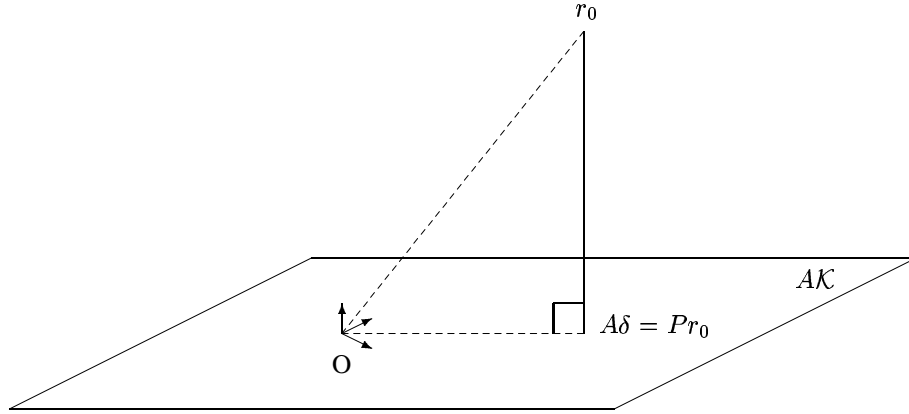

Figure 5.2 Interpretation of the projection process for the case when $\mathcal{L} = A\mathcal{K}$.

Now consider the case where $\mathcal{L} = \mathcal{K}$ and A is Symmetric Positive Definite. Let $d_0 = x_* - x_0$ be the initial error, where x_* denotes the exact solution to the system and, similarly, let $\tilde{d} = x_* - \tilde{x}$ where $\tilde{x} = x_0 + \delta$ is the approximate solution resulting from the projection step. Then (5.9) yields the relation

$$A\tilde{d} = \tilde{r} = A(d_0 - \delta),$$

where δ is now obtained by constraining the residual vector $r_0 - A\delta$ to be orthogonal to \mathcal{K} :

$$(r_0 - A\delta, w) = 0, \quad \forall w \in \mathcal{K}.$$

The above condition is equivalent to

$$(A(d_0 - \delta), w) = 0, \quad \forall w \in \mathcal{K}.$$

Since A is SPD, it defines an inner product (see Section 1.11) which is usually denoted by $(\cdot, \cdot)_A$ and the above condition becomes

$$(d_0 - \delta, w)_A = 0, \quad \forall w \in \mathcal{K}.$$

The above condition is now easy to interpret: *The vector δ is the A -orthogonal projection of the initial error d_0 onto the subspace \mathcal{K} .*

PROPOSITION 5.5 Let \tilde{x} be the approximate solution obtained from an orthogonal projection process onto \mathcal{K} and let $\tilde{d} = x_* - \tilde{x}$ be the associated error vector. Then,

$$\tilde{d} = (I - P_A)d_0,$$

where P_A denotes the projector onto the subspace \mathcal{K} , which is orthogonal with respect to the A -inner product.

A result of the proposition is that the A -norm of the error vector obtained after one projection step does not exceed the initial A -norm of the error, i.e.,

$$\|\tilde{d}\|_A \leq \|d_0\|_A,$$

which is expected because it is known that the A -norm of the error is minimized in $x_0 + \mathcal{K}$. This class of methods may be termed *error projection methods*.

5.2.3 GENERAL ERROR BOUND

If no vector of the subspace \mathcal{K} comes close to the exact solution x , then it is impossible to find a good approximation \tilde{x} to x from \mathcal{K} . Therefore, the approximation obtained by any projection process based on \mathcal{K} will be poor. On the other hand, if there is some vector in \mathcal{K} which is a small distance ϵ away from x , then the question is: How good can the approximate solution be? The purpose of this section is to try to answer this question.

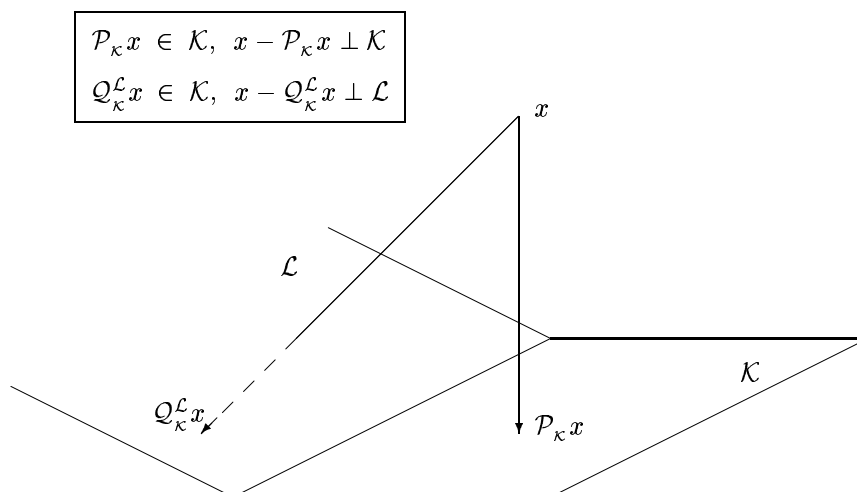

Figure 5.3 *Orthogonal and oblique projectors.*

Let $\mathcal{P}_{\mathcal{K}}$ be the orthogonal projector onto the subspace \mathcal{K} and let $\mathcal{Q}_{\mathcal{K}}^{\mathcal{L}}$ be the (oblique) projector onto \mathcal{K} and orthogonally to \mathcal{L} . These projectors are defined by

$$\begin{aligned} \mathcal{P}_{\mathcal{K}}x &\in \mathcal{K}, x - \mathcal{P}_{\mathcal{K}}x \perp \mathcal{K}, \\ \mathcal{Q}_{\mathcal{K}}^{\mathcal{L}}x &\in \mathcal{K}, x - \mathcal{Q}_{\mathcal{K}}^{\mathcal{L}}x \perp \mathcal{L}, \end{aligned}$$

and are illustrated in Figure 5.3. The symbol A_m is used to denote the operator

$$A_m = \mathcal{Q}_{\mathcal{K}}^{\mathcal{L}}A\mathcal{P}_{\mathcal{K}},$$

and it is assumed, without loss of generality, that $x_0 = 0$. Then according to the property (1.54), the approximate problem defined in (5.5 – 5.6) can be reformulated as follows: find $\tilde{x} \in \mathcal{K}$ such that

$$\mathcal{Q}_{\mathcal{K}}^{\mathcal{L}}(b - A\tilde{x}) = 0,$$

or, equivalently,

$$A_m \tilde{x} = Q_{\mathcal{K}}^{\mathcal{L}} b, \quad \tilde{x} \in \mathcal{K}.$$

Thus, an n -dimensional linear system is approximated by an m -dimensional one.

The following proposition examines what happens in the particular case when the subspace \mathcal{K} is invariant under A . This is a rare occurrence in practice, but the result helps in understanding the breakdown behavior of the methods to be considered in later chapters.

PROPOSITION 5.6 *Assume that \mathcal{K} is invariant under A , $x_0 = 0$, and b belongs to \mathcal{K} . Then the approximate solution obtained from any (oblique or orthogonal) projection method onto \mathcal{K} is exact.*

Proof. An approximate solution \tilde{x} is defined by

$$Q_{\mathcal{K}}^{\mathcal{L}}(b - A\tilde{x}) = 0,$$

where \tilde{x} is a nonzero vector in \mathcal{K} . The right-hand side b is in \mathcal{K} , so we have $Q_{\mathcal{K}}^{\mathcal{L}} b = b$. Similarly, \tilde{x} belongs to \mathcal{K} which is invariant under A , and therefore, $Q_{\mathcal{K}}^{\mathcal{L}} A\tilde{x} = A\tilde{x}$. Then the above equation becomes

$$b - A\tilde{x} = 0,$$

showing that \tilde{x} is an exact solution. ■

The result can be extended trivially to the case where $x_0 \neq 0$. The required assumption in this case is that the initial residual $r_0 = b - Ax_0$ belongs to the invariant subspace \mathcal{K} .

An important quantity for the convergence properties of projection methods is the distance $\|(I - \mathcal{P}_{\mathcal{K}})x_*\|_2$ of the exact solution x_* from the subspace \mathcal{K} . This quantity plays a key role in the analysis of projection methods. Note that the solution x_* cannot be well approximated from \mathcal{K} , if $\|(I - \mathcal{P}_{\mathcal{K}})x_*\|_2$ is not small because

$$\|\tilde{x} - x_*\|_2 \geq \|(I - \mathcal{P}_{\mathcal{K}})x_*\|_2.$$

The fundamental quantity $\|(I - \mathcal{P}_{\mathcal{K}})x_*\|_2 / \|x_*\|_2$ is the *sine* of the acute angle between the solution x_* and the subspace \mathcal{K} . The following theorem establishes an upper bound for the residual norm of the *exact* solution with respect to the approximate operator A_m .

THEOREM 5.1 *Let $\gamma = \|Q_{\mathcal{K}}^{\mathcal{L}} A(I - \mathcal{P}_{\mathcal{K}})\|_2$ and assume that b is a member of \mathcal{K} and $x_0 = 0$. Then the exact solution x_* of the original problem is such that*

$$\|b - A_m x_*\|_2 \leq \gamma \|(I - \mathcal{P}_{\mathcal{K}})x_*\|_2. \quad (5.11)$$

Proof. Since $b \in \mathcal{K}$, then

$$\begin{aligned} b - A_m x_* &= Q_{\mathcal{K}}^{\mathcal{L}}(b - A\mathcal{P}_{\mathcal{K}}x_*) \\ &= Q_{\mathcal{K}}^{\mathcal{L}}(Ax_* - A\mathcal{P}_{\mathcal{K}}x_*) \\ &= Q_{\mathcal{K}}^{\mathcal{L}}A(x_* - \mathcal{P}_{\mathcal{K}}x_*) \\ &= Q_{\mathcal{K}}^{\mathcal{L}}A(I - \mathcal{P}_{\mathcal{K}})x_*. \end{aligned}$$

Noting that $I - \mathcal{P}_\kappa$ is a projector, it follows that

$$\begin{aligned}\|b - A_m x_*\|_2 &= \|\mathcal{Q}_\kappa^\mathcal{L} A (I - \mathcal{P}_\kappa) (I - \mathcal{P}_\kappa) x_*\|_2 \\ &\leq \|\mathcal{Q}_\kappa^\mathcal{L} A (I - \mathcal{P}_\kappa)\|_2 \|(I - \mathcal{P}_\kappa) x_*\|_2,\end{aligned}$$

which completes the proof. \blacksquare

It is useful to consider a matrix interpretation of the theorem. We consider only the particular case of orthogonal projection methods ($\mathcal{L} = \mathcal{K}$). Assume that V is unitary, i.e., that the basis $\{v_1, \dots, v_m\}$ is orthonormal, and that $W = V$. Observe that $b = VV^T b$. Equation (5.11) can be represented in the basis V as

$$\|b - V(V^T A V)V^T x_*\|_2 \leq \gamma \|(I - \mathcal{P}_\kappa) x_*\|_2.$$

However,

$$\begin{aligned}\|b - V(V^T A V)V^T x_*\|_2 &= \|V(V^T b - (V^T A V)V^T x_*\|_2 \\ &= \|V^T b - (V^T A V)V^T x_*\|_2.\end{aligned}$$

Thus, the projection of the exact solution has a residual norm with respect to the matrix $B = V^T A V$, which is of the order of $\|(I - \mathcal{P}_\kappa) x_*\|_2$.

ONE-DIMENSIONAL PROJECTION PROCESSES

5.3

This section examines simple examples provided by one-dimensional projection processes. In what follows, the vector r denotes the residual vector $r = b - Ax$ for the current approximation x . To avoid subscripts, arrow notation is used to denote *vector updates*. Thus, “ $x \leftarrow x + \alpha r$ ” means “compute $x + \alpha r$ and overwrite the result on the current x .” (This is known as a SAXPY operation.)

One-dimensional projection processes are defined when

$$\mathcal{K} = \text{span}\{v\} \quad \text{and} \quad \mathcal{L} = \text{span}\{w\},$$

where v and w are two vectors. In this case, the new approximation takes the form $x \leftarrow x + \alpha v$ and the Petrov-Galerkin condition $r - A\delta \perp w$ yields

$$\alpha = \frac{(r, w)}{(Av, w)}. \tag{5.12}$$

Following are three popular choices to be considered.

5.3.1 STEEPEST DESCENT

The steepest descent algorithm is defined for the case where the matrix A is Symmetric Positive Definite. It consists of taking at each step $v = r$ and $w = r$. This yields an iteration described by the following algorithm.

ALGORITHM 5.2: Steepest Descent Algorithm

1. *Until convergence, Do:*
2. $r \leftarrow b - Ax$
3. $\alpha \leftarrow (r, r)/(Ar, r)$
4. $x \leftarrow x + \alpha r$
5. *EndDo*

Each step of the above iteration minimizes

$$f(x) = \|x - x_*\|_A^2 = (A(x - x_*), (x - x_*)),$$

over all vectors of the form $x + \alpha d$, where d is the negative of the gradient direction $-\nabla f$. The negative of the gradient direction is *locally* the direction that yields the fastest rate of decrease for f . Next, we prove that convergence is guaranteed when A is SPD. The result is a consequence of the following lemma known as the Kantorovich inequality.

LEMMA 5.1 (Kantorovich inequality) *Let B be any Symmetric Positive Definite real matrix and λ_{max} , λ_{min} its largest and smallest eigenvalues. Then,*

$$\frac{(Bx, x)(B^{-1}x, x)}{(x, x)^2} \leq \frac{(\lambda_{max} + \lambda_{min})^2}{4\lambda_{max}\lambda_{min}}, \quad \forall x \neq 0. \quad (5.13)$$

Proof. Clearly, it is equivalent to show that the result is true for any unit vector x . Since B is symmetric, it is unitarily similar to a diagonal matrix, $B = Q^T D Q$, and

$$\begin{aligned} (Bx, x)(B^{-1}x, x) &= (Q^T D Q x, x)(Q^T D^{-1} Q x, x) \\ &= (D Q x, Q x)(D^{-1} Q x, Q x). \end{aligned}$$

Setting $y = Qx = (y_1, \dots, y_n)^T$, and $\beta_i = y_i^2$, note that

$$\lambda \equiv (Dy, y) = \sum_{i=1}^n \beta_i \lambda_i$$

is a convex combination of the eigenvalues λ_i , $i = 1, \dots, n$. The following relation holds,

$$(Bx, x)(B^{-1}x, x) = \lambda\psi(y)$$

with

$$\psi(y) = (D^{-1}y, y) = \sum_{i=1}^n \beta_i \frac{1}{\lambda_i}.$$

Noting that the function $1/x$ is convex, $\psi(y)$ is bounded from above by the linear curve that joins the points $(\lambda_1, 1/\lambda_1)$ and $(\lambda_n, 1/\lambda_n)$, i.e.,

$$\psi(y) \leq \frac{1}{\lambda_1} + \frac{1}{\lambda_n} - \frac{\lambda}{\lambda_1 \lambda_n}.$$

Therefore,

$$(Bx, x)(B^{-1}x, x) = \lambda\psi(y) \leq \lambda \left(\frac{1}{\lambda_1} + \frac{1}{\lambda_n} - \frac{\lambda}{\lambda_1 \lambda_n} \right).$$

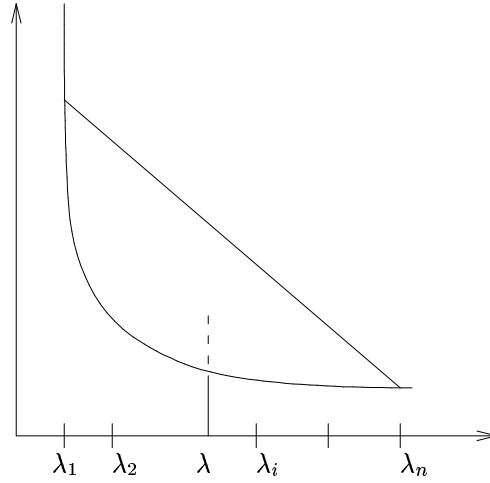

The maximum of the right-hand side is reached for $\lambda = \frac{1}{2}(\lambda_1 + \lambda_n)$ yielding,

$$(Bx, x)(B^{-1}x, x) = \lambda\psi(y) \leq \frac{(\lambda_1 + \lambda_n)^2}{4\lambda_1 \lambda_n}$$

which gives the desired result. \blacksquare

This lemma helps to establish the following result regarding the convergence rate of the method.

THEOREM 5.2 *Let A be a Symmetric Positive Definite matrix. Then, the A -norms of the error vectors $d_k = x_* - x_k$ generated by Algorithm 5.2 satisfy the relation*

$$\|d_{k+1}\|_A \leq \frac{\lambda_{max} - \lambda_{min}}{\lambda_{max} + \lambda_{min}} \|d_k\|_A, \quad (5.14)$$

and Algorithm 5.2 converges for any initial guess x_0 .

Proof. Start by observing that $\|d_{k+1}\|_A^2 = (Ad_{k+1}, d_{k+1}) = (r_{k+1}, d_{k+1})$ and then by simple substitution,

$$\|d_{k+1}\|_A^2 = (r_{k+1}, d_k - \alpha_k r_k)$$

Since by construction the new residual vector r_{k+1} must be orthogonal to the search direction r_k , the second term in the right-hand side of the above equation is zero. Thus,

$$\|d_{k+1}\|_A^2 = (r_k - \alpha_k Ar_k, d_k) \quad (5.15)$$

$$= (r_k, A^{-1}r_k) - \alpha_k (r_k, r_k) \quad (5.16)$$

$$= \|d_k\|_A^2 \left(1 - \frac{(r_k, r_k)}{(r_k, Ar_k)} \times \frac{(r_k, r_k)}{(r_k, A^{-1}r_k)} \right). \quad (5.17)$$

The result follows by applying the Kantorovich inequality (5.13). \blacksquare

5.3.2 MINIMAL RESIDUAL (MR) ITERATION

We now assume that A is not necessarily symmetric but only positive definite, i.e., its symmetric part $A + A^T$ is Symmetric Positive Definite. Taking at each step $v = r$ and $w = Ar$, the following iterative procedure results.

ALGORITHM 5.3: Minimal Residual Iteration

1. *Until convergence, Do:*
 2. $r \leftarrow b - Ax$
 3. $\alpha \leftarrow (Ar, r)/(Ar, Ar)$
 4. $x \leftarrow x + \alpha r$
 5. *EndDo*
-

Here, each step minimizes $f(x) = \|b - Ax\|_2^2$ in the direction r . The iteration converges under the condition that A is positive definite as is stated in the next theorem.

THEOREM 5.3 *Let A be a real positive definite matrix, and let*

$$\mu = \lambda_{\min}(A + A^T)/2, \quad \sigma = \|A\|_2.$$

Then the residual vectors generated by Algorithm 5.3 satisfy the relation

$$\|r_{k+1}\|_2 \leq \left(1 - \frac{\mu^2}{\sigma^2}\right)^{1/2} \|r_k\|_2 \quad (5.18)$$

and Algorithm (5.3) converges for any initial guess x_0 .

Proof. We proceed similarly to the steepest descent method, starting with the relation

$$\|r_{k+1}\|_2^2 = (r_k - \alpha_k Ar_k, r_k - \alpha_k Ar_k) \quad (5.19)$$

$$= (r_k - \alpha_k Ar_k, r_k) - \alpha_k (r_k - \alpha_k Ar_k, Ar_k). \quad (5.20)$$

By construction, the new residual vector $r_k - \alpha_k Ar_k$ must be orthogonal to the search direction Ar_k , and, as a result, the second term in the right-hand side of the above equation vanishes and we obtain

$$\begin{aligned} \|r_{k+1}\|_2^2 &= (r_k - \alpha_k Ar_k, r_k) \\ &= (r_k, r_k) - \alpha_k (Ar_k, r_k) \\ &= \|r_k\|_2^2 \left(1 - \frac{(Ar_k, r_k)}{(r_k, r_k)} \frac{(Ar_k, r_k)}{(Ar_k, Ar_k)}\right) \\ &= \|r_k\|_2^2 \left(1 - \frac{(Ar_k, r_k)^2}{(r_k, r_k)^2} \frac{\|r_k\|_2^2}{\|Ar_k\|_2^2}\right). \end{aligned} \quad (5.21)$$

From Theorem 1.19, it can be stated that

$$\frac{(Ax, x)}{(x, x)} \geq \mu > 0, \quad (5.22)$$

where $\mu = \lambda_{\min}(A + A^T)/2$. The desired result follows immediately by using the inequality $\|Ar_k\|_2 \leq \|A\|_2 \|r_k\|_2$. ■

There are alternative ways of obtaining inequalities that prove convergence. For example, starting from (5.21), (5.22) can be used again for the term $(Ar_k, r_k)/(r_k, r_k)$ and similarly, we can write

$$\frac{(Ax, x)}{(Ax, Ax)} = \frac{(Ax, A^{-1}(Ax))}{(Ax, Ax)} \geq \lambda_{\min} \left(\frac{A^{-1} + A^{-T}}{2} \right) > 0,$$

since A^{-1} is also positive definite. This would yield the inequality

$$\|r_{k+1}\|_2^2 \leq (1 - \mu(A)\mu(A^{-1})) \|r_k\|_2^2, \quad (5.23)$$

in which $\mu(B) = \lambda_{\min}(B + B^T)/2$.

Another interesting observation is that if we define

$$\cos \angle_k = \frac{(Ar_k, r_k)}{\|Ar_k\|_2 \|r_k\|_2},$$

then (5.21) can be rewritten as

$$\begin{aligned} \|r_{k+1}\|_2^2 &= \|r_k\|_2^2 \left(1 - \frac{(Ar_k, r_k)}{(Ar_k, Ar_k)} \frac{(Ar_k, r_k)}{(r_k, r_k)} \right) \\ &= \|r_k\|_2^2 (1 - \cos^2 \angle_k) \\ &= \|r_k\|_2^2 \sin^2 \angle_k. \end{aligned}$$

At each step the reduction in the residual norm is equal to the *sine* of the acute angle between r and Ar . The convergence factor is therefore bounded by

$$\rho = \max_{x \in \mathbb{R}^n, x \neq 0} \sin \angle(x, Ax),$$

in which $\angle(x, Ax)$ is the acute angle between x and Ax . The maximum angle $\angle(x, Ax)$ is guaranteed to be less than $\pi/2$ when A is positive definite as the above results show.

5.3.3 RESIDUAL NORM STEEPEST DESCENT

In the residual norm steepest descent algorithm, the assumption that A is positive definite is relaxed. In fact, the only requirement is that A is a (square) nonsingular matrix. At each step the algorithm uses $v = A^T r$ and $w = Av$, giving the following sequence of operations:

$$\begin{aligned} r &\leftarrow b - Ax, v = A^T r, \\ \alpha &\leftarrow \|v\|_2^2 / \|Av\|_2^2, \\ x &\leftarrow x + \alpha v. \end{aligned} \quad (5.24)$$

However, an algorithm based on the above sequence of operations would require three matrix-by-vector products, which is three times as many as the other algorithms seen in this section. The number of matrix-by-vector operations can be reduced to two per step by computing the residual differently. This variant is as follows.

ALGORITHM 5.4: Residual Norm Steepest Descent

1. Compute $r := b - Ax$
2. *Until convergence, Do:*
3. $v := A^T r$
4. Compute Av and $\alpha := \|v\|_2^2 / \|Av\|_2^2$
5. $x := x + \alpha v$
6. $r := r - \alpha Av$
7. *EndDo*

Here, each step minimizes $f(x) = \|b - Ax\|_2^2$ in the direction $-\nabla f$. As it turns out, this is equivalent to the steepest descent algorithm of Section 5.3.1 applied to the normal equations $A^T A x = A^T b$. Since $A^T A$ is positive definite when A is nonsingular, then, according to Theorem 5.2, the method will converge whenever A is nonsingular.

ADDITIVE AND MULTIPLICATIVE PROCESSES

5.4

We begin by considering again the block relaxation techniques seen in the previous chapter. To define these techniques, a *set-decomposition* of $S = \{1, 2, \dots, n\}$ is considered as the definition of p subsets S_1, \dots, S_p of S with

$$S_i \subseteq S, \quad \bigcup_{i=1, \dots, p} S_i = S.$$

Denote by n_i the size of S_i and define the subset S_i as

$$S_i = \{m_i(1), m_i(2), \dots, m_i(n_i)\}.$$

Let V_i be the $n \times n_i$ matrix

$$V_i = [e_{m_i(1)}, e_{m_i(2)}, \dots, e_{m_i(n_i)}],$$

where each e_j is the j -th column of the $n \times n$ identity matrix.

If the block Jacobi and block Gauss-Seidel algorithms, Algorithms 4.1 and 4.2, are examined carefully, it can be observed that each individual step in the main loop (lines 2 to 5) represents an orthogonal projection process over $K_i = \text{span}\{V_i\}$. Indeed, the equation (4.17) is exactly (5.7) with $W = V = V_i$. This individual projection step modifies only the components corresponding to the subspace K_i . However, the general block Jacobi iteration combines these modifications, implicitly adding them together, to obtain the next iterate x_{k+1} . Borrowing from the terminology of domain decomposition techniques, this will be called an *additive projection procedure*. Generally, an additive projection procedure can be defined for any sequence of subspaces K_i , not just subspaces spanned by the columns of the identity matrix. The only requirement is that the subspaces K_i should be distinct, although they are allowed to overlap.

Let a sequence of p orthogonal systems V_i be given, with the condition that $\text{span}\{V_i\}$

$\neq \text{span}\{V_j\}$ for $i \neq j$, and define

$$A_i = V_i^T A V_i.$$

The additive projection procedure can be written as

$$\begin{aligned} y_i &= A_i^{-1} V_i^T (b - A x_k), \quad i = 1, \dots, p, \\ x_{k+1} &= x_k + \sum_{i=1}^p V_i y_i, \end{aligned} \quad (5.25)$$

which leads to the following algorithm.

ALGORITHM 5.5: Additive Projection Procedure

1. For $k = 0, 1, \dots$, until convergence, Do:
 2. For $i = 1, 2, \dots, p$ Do:
 3. Solve $A_i y_i = V_i^T (b - A x_k)$
 4. EndDo
 5. Set $x_{k+1} = x_k + \sum_{i=1}^p V_i y_i$
 6. EndDo
-

Defining $r_k = b - A x_k$, the residual vector at step k , then clearly

$$\begin{aligned} r_{k+1} &= b - A x_{k+1} \\ &= b - A x_k - \sum_{i=1}^p A V_i (V_i^T A V_i)^{-1} V_i^T r_k \\ &= \left[I - \sum_{i=1}^p A V_i (V_i^T A V_i)^{-1} V_i^T \right] r_k. \end{aligned}$$

Observe that each of the p operators

$$P_i = A V_i (V_i^T A V_i)^{-1} V_i^T$$

represents the projector onto the subspace spanned by $A V_i$, and orthogonal to V_i . Often, the additive processes are used in conjunction with an acceleration parameter ω , thus (5.25) is replaced by

$$\begin{aligned} y_i &= A_i^{-1} V_i^T (b - A x_k), \quad i = 1, \dots, p, \\ x_{k+1} &= x_k + \omega \sum_{i=1}^p V_i y_i. \end{aligned}$$

Even more generally, a different parameter ω_i can be used for each projection, i.e.,

$$\begin{aligned} y_i &= A_i^{-1} V_i^T (b - A x_k), \quad i = 1, \dots, p, \\ x_{k+1} &= x_k + \sum_{i=1}^p \omega_i V_i y_i. \end{aligned}$$

The residual norm in this situation is given by

$$r_{k+1} = \left(I - \sum_{i=1}^p \omega_i P_i \right) r_k, \quad (5.26)$$

considering the single ω parameter as a particular case. Exercise 14 gives an example of the choice of ω_i which has the effect of producing a sequence with decreasing residual norms.

We now return to the generic case, where $\omega_i = 1, \forall i$. A least-squares option can be defined by taking for each of the subproblems $L_i = AK_i$. In this situation, P_i becomes an orthogonal projector onto AK_i , since

$$P_i = AV_i ((AV_i)^T AV_i)^{-1} (AV_i)^T.$$

It is interesting to note that the residual vector obtained after one outer loop is related to the previous residual by

$$r_{k+1} = \left(I - \sum_{i=1}^p P_i \right) r_k,$$

where the P_i 's are now orthogonal projectors. In particular, in the ideal situation when the AV_i 's are orthogonal to each other, and the total rank of the P_i 's is n , then the exact solution would be obtained in one outer step, since in this situation

$$I - \sum_{i=1}^p P_i = 0.$$

Thus, the maximum reduction in the residual norm is achieved when the V_i 's are A -orthogonal to one another.

Similar to the Jacobi and Gauss-Seidel iterations, what distinguishes the additive and multiplicative iterations is that the latter updates the component to be corrected at step i immediately. Then this updated approximate solution is used to compute the residual vector needed to correct the next component. The Jacobi iteration uses the same previous approximation x_k to update all the components of the solution. Thus, the analogue of the block Gauss-Seidel iteration can be defined as follows.

ALGORITHM 5.6: Multiplicative Projection Procedure

1. *Until convergence, Do:*
 2. *For* $i = 1, 2, \dots, p$ *Do:*
 3. *Solve* $A_i y = V_i^T (b - Ax)$
 4. *Set* $x := x + V_i y$
 5. *EndDo*
 6. *EndDo*
-

EXERCISES

1. Consider the linear system $Ax = b$, where A is a Symmetric Positive Definite matrix.

- a. Consider the sequence of one-dimensional projection processes with $\mathcal{K} = \mathcal{L} = \text{span}\{e_i\}$, where the sequence of indices i is selected in any fashion. Let x_{new} be a new iterate after one projection step from x and let $r = b - Ax$, $d = A^{-1}b - x$, and $d_{new} = A^{-1}b - x_{new}$. Show that

$$(Ad_{new}, d_{new}) = (Ad, d) - (r, e_i)^2 / a_{ii}.$$

Does this equality, as is, establish convergence of the algorithm?

- b. Assume now that i is selected at each projection step to be the index of a component of largest absolute value in the current residual vector $r = b - Ax$. Show that

$$\|d_{new}\|_A \leq \left(1 - \frac{1}{n\kappa^2(A)}\right)^{1/2} \|d\|_A,$$

in which $\kappa(A)$ is the spectral condition number of A . [Hint: Use the inequality $|e_i^T r| \geq n^{-1/2} \|r\|_2$.] Does this prove that the algorithm converges?

2. Consider the linear system $Ax = b$, where A is a Symmetric Positive Definite matrix. Consider a projection step with $\mathcal{K} = \mathcal{L} = \text{span}\{v\}$ where v is some nonzero vector. Let x_{new} be the new iterate after one projection step from x and let $d = A^{-1}b - x$, and $d_{new} = A^{-1}b - x_{new}$.

- a. Show that

$$(Ad_{new}, d_{new}) = (Ad, d) - (r, v)^2 / (Av, v).$$

Does this equality establish convergence of the algorithm?

- b. In Gastinel's method, the vector v is selected in such a way that $(v, r) = \|r\|_1$, e.g., by defining the components of v to be $v_i = \text{sign}(e_i^T r)$, where $r = b - Ax$ is the current residual vector. Show that

$$\|d_{new}\|_A \leq \left(1 - \frac{1}{n\kappa^2(A)}\right)^{1/2} \|d\|_A,$$

in which $\kappa(A)$ is the spectral condition number of A . Does this prove that the algorithm converges?

- c. Compare the cost of one step of this method with that of cyclic Gauss-Seidel (see Example 5.1) and that of "optimal" Gauss-Seidel where at each step $\mathcal{K} = \mathcal{L} = \text{span}\{e_i\}$ and i is a component of largest magnitude in the current residual vector.

3. In Section 5.3.3, it was shown that taking a one-dimensional projection technique with $\mathcal{K} = \text{span}\{A^T r\}$ and $\mathcal{L} = \text{span}\{AA^T r\}$ is mathematically equivalent to using the usual steepest descent algorithm applied to the normal equations $A^T Ax = A^T b$. Show that an orthogonal projection method for $A^T Ax = A^T b$ using a subspace \mathcal{K} is mathematically equivalent to applying a projection method onto \mathcal{K} , orthogonally to $\mathcal{L} = A\mathcal{K}$ for solving the system $Ax = b$.

4. Consider the matrix

$$A = \begin{pmatrix} 1 & -6 & 0 \\ 6 & 2 & 3 \\ 0 & 3 & 2 \end{pmatrix}.$$

- a. Find a rectangle or square in the complex plane which contains all the eigenvalues of A , without computing the eigenvalues.
- b. Is the Minimal Residual iteration guaranteed to converge for a linear system with the matrix A ?

5. Consider the linear system

$$\begin{pmatrix} D_1 & -F \\ -E & -D_2 \end{pmatrix} \begin{pmatrix} x_1 \\ x_2 \end{pmatrix} = \begin{pmatrix} b_1 \\ b_2 \end{pmatrix}$$

in which D_1 and D_2 are both nonsingular matrices of size m each.

- a. Define an orthogonal projection method using the set of vectors e_1, \dots, e_m , i.e., $\mathcal{L} = \mathcal{K} = \text{span}\{e_1, \dots, e_m\}$. Write down the corresponding projection step (x_1 is modified into \tilde{x}_1). Similarly, write the projection step for the second half of the vectors, i.e., when $\mathcal{L} = \mathcal{K} = \text{span}\{e_{m+1}, \dots, e_n\}$.
 - b. Consider an iteration procedure which consists of performing the two successive half-steps described above until convergence. Show that this iteration is equivalent to a (standard) Gauss-Seidel iteration applied to the original system.
 - c. Now consider a similar idea in which \mathcal{K} is taken to be the same as before for each half-step and $\mathcal{L} = A\mathcal{K}$. Write down the iteration procedure based on this approach. Name another technique to which it is mathematically equivalent.
6. Consider the linear system $Ax = b$, where A is a Symmetric Positive Definite matrix. We define a projection method which uses a two-dimensional space at each step. At a given step, take $\mathcal{L} = \mathcal{K} = \text{span}\{r, Ar\}$, where $r = b - Ax$ is the current residual.
- a. For a basis of \mathcal{K} use the vector r and the vector p obtained by orthogonalizing Ar against r with respect to the A -inner product. Give the formula for computing p (no need to normalize the resulting vector).
 - b. Write the algorithm for performing the projection method described above.
 - c. Will the algorithm converge for any initial guess x_0 ? Justify the answer. [Hint: Exploit the convergence results for one-dimensional projection techniques.]
7. Consider projection methods which update at each step the current solution with linear combinations from two directions: the current residual r and Ar .
- a. Consider an orthogonal projection method, i.e., at each step $\mathcal{L} = \mathcal{K} = \text{span}\{r, Ar\}$. Assuming that A is Symmetric Positive Definite, establish convergence of the algorithm.
 - b. Consider a least-squares projection method in which at each step $\mathcal{K} = \text{span}\{r, Ar\}$ and $\mathcal{L} = A\mathcal{K}$. Assuming that A is positive definite (not necessarily symmetric), establish convergence of the algorithm.
- [Hint: The convergence results for any of the one-dimensional projection techniques can be exploited.]
8. The “least-squares” Gauss-Seidel relaxation method defines a relaxation step as $x_{new} = x + \delta e_i$ (same as Gauss-Seidel), but chooses δ to minimize the residual norm of x_{new} .
- a. Write down the resulting algorithm.
 - b. Show that this iteration is mathematically equivalent to a Gauss-Seidel iteration applied to the normal equations $A^T Ax = A^T b$.
9. Derive three types of one-dimensional projection algorithms in the same manner as was done in Section 5.3, by replacing every occurrence of the residual vector r by a vector e_i , a column of the identity matrix.

10. Derive three types of one-dimensional projection algorithms in the same manner as was done in Section 5.3, by replacing every occurrence of the residual vector r by a vector Ae_i , a column of the matrix A . What would be an “optimal” choice for i at each projection step? Show that the method is globally convergent in this case.
11. A minimal residual iteration as defined in Section 5.3.2 can also be defined for an arbitrary search direction d , not necessarily related to r in any way. In this case, we still define $e = Ad$.
- Write down the corresponding algorithm.
 - Under which condition are all iterates defined?
 - Under which condition on d does the new iterate make no progress, i.e., $\|r_{k+1}\|_2 = \|r_k\|_2$?
 - Write a general sufficient condition which must be satisfied by d at each step in order to guarantee convergence.
12. Consider the following real-valued functions of the vector variable x , where A and b are the coefficient matrix and right-hand system of a given linear system $Ax = b$ and $x_* = A^{-1}b$.

$$\begin{aligned} a(x) &= \|x_* - x\|_2^2, \\ f(x) &= \|b - Ax\|_2^2, \\ g(x) &= \|A^T b - A^T Ax\|_2^2, \\ h(x) &= 2(b, x) - (Ax, x). \end{aligned}$$

- Calculate the gradients of all four functions above.
 - How is the gradient of g related to that of f ?
 - How is the gradient of f related to that of h when A is symmetric?
 - How does the function h relate to the A -norm of the error $x_* - x$ when A is Symmetric Positive Definite?
13. The block Gauss-Seidel iteration can be expressed as a method of successive projections. The subspace \mathcal{K} used for each projection is of the form

$$\mathcal{K} = \text{span}\{e_i, e_{i+1}, \dots, e_{i+p}\}.$$

What is \mathcal{L} ? Not too commonly used an alternative is to take $\mathcal{L} = A\mathcal{K}$, which amounts to solving a least-squares problem instead of a linear system. Develop algorithms for this case. What are the advantages and disadvantages of the two approaches (ignoring convergence rates)?

14. Let the scalars ω_i in the additive projection procedure satisfy the constraint

$$\sum_{i=1}^p \omega_i = 1. \quad (5.27)$$

It is not assumed that each ω_i is positive but only that $|\omega_i| \leq 1$ for all i . The residual vector is given by the Formula (5.26) or, equivalently,

$$r_{k+1} = \sum_{i=1}^p \omega_i (I - P_i) r_k.$$

- Show that in the least-squares case, we have $\|r_{k+1}\|_2 \leq \|r_k\|_2$ for any choice of ω_i 's which satisfy the constraint (5.27).
- We wish to choose a set of ω_i 's such that the 2-norm of the residual vector r_{k+1} is minimal. Determine this set of ω_i 's, assuming that the vectors $(I - P_i)r_k$ are all linearly independent.

- c. The “optimal” ω_i 's provided in the previous question require the solution of a $p \times p$ Symmetric Positive Definite linear system. Let $z_i \equiv V_i y_i$ be the “search directions” provided by each of the individual projection steps. To avoid this difficulty, a simpler strategy is used which consists of performing p successive minimal residual iterations along these search directions, as is described below.

```

r := r_k
For i = 1, . . . , p Do:
    ω_i := (r, Az_i) / (Az_i, Az_i)
    x := x + ω_i z_i
    r := r - ω_i Az_i
EndDo

```

Show that $\|r_{k+1}\|_2 \leq \|r_k\|_2$. Give a sufficient condition to ensure global convergence.

15. Consider the iteration: $x_{k+1} = x_k + \alpha_k d_k$, where d_k is a vector called the *direction of search*, and α_k is a scalar. It is assumed throughout that d_k is a nonzero vector. Consider a method which determines x_{k+1} so that the residual $\|r_{k+1}\|_2$ is the smallest possible.
- Determine α_k so that $\|r_{k+1}\|_2$ is minimal.
 - Show that the residual vector r_{k+1} obtained in this manner is orthogonal to Ar_k .
 - Show that the residual vectors satisfy the relation:

$$\|r_{k+1}\|_2 \leq \|r_k\|_2 \sin \angle(r_k, Ad_k).$$

- Assume that at each step k , we have $(r_k, Ad_k) \neq 0$. Will the method always converge?
 - Now assume that A is positive definite and select at each step $d_k \equiv r_k$. Prove that the method will converge for any initial guess x_0 .
16. Consider the iteration: $x_{k+1} = x_k + \alpha_k d_k$, where d_k is a vector called the *direction of search*, and α_k is a scalar. It is assumed throughout that d_k is a vector which is selected in the form $d_k = A^T f_k$ where f_k is some nonzero vector. Let $x_* = A^{-1}b$ be the exact solution. Now consider a method which at each step k determines x_{k+1} so that the error norm $\|x_* - x_{k+1}\|_2$ is the smallest possible.
- Determine α_k so that $\|x_* - x_{k+1}\|_2$ is minimal and show that the error vector $e_{k+1} = x_* - x_{k+1}$ is orthogonal to d_k . The expression of α_k should not contain unknown quantities (e.g., x_* or e_k).
 - Show that $\|e_{k+1}\|_2 \leq \|e_k\|_2 \sin \angle(e_k, d_k)$.
 - Establish the convergence of the algorithm for any x_0 , when $f_k \equiv r_k$ for all k .

NOTES AND REFERENCES. Initially, the term *projection methods* was used mainly to describe one-dimensional techniques such as those presented in Section 5.3. An excellent account of what has been done in the late 1950s and early 1960s can be found in Householder's book [122] as well as Gastinel [101]. For more general, including nonlinear, projection processes, a good reference is Kranoselskii and co-authors [138].

Projection techniques are present in different forms in many other areas of scientific computing and can be formulated in abstract Hilbert functional spaces. The terms *Galerkin* and *Petrov-Galerkin* techniques are used commonly in finite element methods to describe projection methods on finite element spaces. The principles are identical to those seen in this chapter. ■

KRYLOV SUBSPACE METHODS PART I

The next two chapters explore a few methods which are considered currently to be among the most important iterative techniques available for solving large linear systems. These techniques are based on projection processes, both orthogonal and oblique, onto Krylov subspaces, which are subspaces spanned by vectors of the form $p(A)v$ where p is a polynomial. In short, these techniques approximate $A^{-1}b$ by $p(A)b$, where p is a “good” polynomial. This chapter covers methods derived from, or related to, the Arnoldi orthogonalization. The next chapter covers methods based on Lanczos biorthogonalization.

INTRODUCTION

6.1

Recall from the previous chapter that a general *projection method* for solving the linear system

$$Ax = b, \tag{6.1}$$

is a method which seeks an approximate solution x_m from an affine subspace $x_0 + \mathcal{K}_m$ of dimension m by imposing the Petrov-Galerkin condition

$$b - Ax_m \perp \mathcal{L}_m,$$

where \mathcal{L}_m is another subspace of dimension m . Here, x_0 represents an arbitrary initial guess to the solution. A Krylov subspace method is a method for which the subspace \mathcal{K}_m is the Krylov subspace

$$\mathcal{K}_m(A, r_0) = \text{span}\{r_0, Ar_0, A^2r_0, \dots, A^{m-1}r_0\},$$

where $r_0 = b - Ax_0$. When there is no ambiguity, $\mathcal{K}_m(A, r_0)$ will be denoted by \mathcal{K}_m . The different versions of Krylov subspace methods arise from different choices of the subspace \mathcal{L}_m and from the ways in which the system is *preconditioned*, a topic that will be covered in detail in later chapters.

Viewed from the angle of approximation theory, it is clear that the approximations obtained from a Krylov subspace method are of the form

$$A^{-1}b \approx x_m = x_0 + q_{m-1}(A)r_0,$$

in which q_{m-1} is a certain polynomial of degree $m - 1$. In the simplest case where $x_0 = 0$, then

$$A^{-1}b \approx q_{m-1}(A)b.$$

In other words, $A^{-1}b$ is approximated by $q_{m-1}(A)b$.

Although all the techniques provide the same type of *polynomial* approximations, the choice of \mathcal{L}_m , i.e., the constraints used to build these approximations, will have an important effect on the iterative technique. Two broad choices for \mathcal{L}_m give rise to the best-known techniques. The first is simply $\mathcal{L}_m = \mathcal{K}_m$ and the minimum-residual variation $\mathcal{L}_m = A\mathcal{K}_m$. A few of the numerous methods in this category will be described in this chapter. The second class of methods is based on defining \mathcal{L}_m to be a Krylov subspace method associated with A^T , namely, $\mathcal{L}_m = \mathcal{K}_m(A^T, r_0)$. Methods of this class will be covered in the next chapter. There are also block extensions of each of these methods termed *block Krylov subspace methods*, which will be discussed only briefly. Note that a projection method may have several different implementations, giving rise to different algorithms which are all mathematically equivalent.

KRYLOV SUBSPACES

6.2

In this section we consider projection methods on *Krylov subspaces*, i.e., subspaces of the form

$$\mathcal{K}_m(A, v) \equiv \text{span} \{v, Av, A^2v, \dots, A^{m-1}v\} \quad (6.2)$$

which will be denoted simply by \mathcal{K}_m if there is no ambiguity. The dimension of the subspace of approximants increases by one at each step of the approximation process. A few elementary properties of Krylov subspaces can be established, many of which need no proof. A first property is that \mathcal{K}_m is the subspace of all vectors in \mathbb{R}^n which can be written as $x = p(A)v$, where p is a polynomial of degree not exceeding $m - 1$. Recall that the minimal polynomial of a vector v is the nonzero monic polynomial p of lowest degree such that $p(A)v = 0$. The degree of the minimal polynomial of v with respect to A is often called the *grade of v with respect to A* , or simply the *grade of v* if there is no ambiguity. A consequence of the Cayley-Hamilton theorem is that the grade of v does not exceed n . The following proposition is easy to prove.

PROPOSITION 6.1 *Let μ be the grade of v . Then \mathcal{K}_μ is invariant under A and $\mathcal{K}_m = \mathcal{K}_\mu$ for all $m \geq \mu$.*

It was mentioned above that the dimension of \mathcal{K}_m is nondecreasing. In fact, the following proposition determines the dimension of \mathcal{K}_m in general.

PROPOSITION 6.2 *The Krylov subspace \mathcal{K}_m is of dimension m if and only if the grade μ of v with respect to A is not less than m , i.e.,*

$$\dim(\mathcal{K}_m) = m \quad \leftrightarrow \quad \text{grade}(v) \geq m.$$

Therefore,

$$\dim(\mathcal{K}_m) = \min \{m, \text{grade}(v)\}.$$

Proof. The vectors $v, Av, \dots, A^{m-1}v$ form a basis of \mathcal{K}_m if and only if for any set of m scalars $\alpha_i, i = 0, \dots, m-1$, where at least one α_i is nonzero, the linear combination $\sum_{i=0}^{m-1} \alpha_i A^i v$ is nonzero. This is equivalent to the condition that the only polynomial of degree $\leq m-1$ for which $p(A)v = 0$ is the zero polynomial. The second part of the proposition is a consequence of the previous proposition. ■

PROPOSITION 6.3 *Let Q_m be any projector onto \mathcal{K}_m and let A_m be the section of A to \mathcal{K}_m , that is, $A_m = Q_m A|_{\mathcal{K}_m}$. Then for any polynomial q of degree not exceeding $m-1$,*

$$q(A)v = q(A_m)v,$$

and for any polynomial of degree $\leq m$,

$$Q_m q(A)v = q(A_m)v.$$

Proof. First we prove that $q(A)v = q(A_m)v$ for any polynomial q of degree $\leq m-1$. It is sufficient to show the property for the monic polynomials $q_i(t) \equiv t^i, i = 0, \dots, m-1$. The proof is by induction. The property is true for the polynomial $q_0(t) \equiv 1$. Assume that it is true for $q_i(t) \equiv t^i$:

$$q_i(A)v = q_i(A_m)v.$$

Multiplying the above equation by A on both sides yields

$$q_{i+1}(A)v = Aq_i(A_m)v.$$

If $i+1 \leq m-1$ the vector on the left-hand side belongs to \mathcal{K}_m , and therefore if the above equation is multiplied on both sides by Q_m , then

$$q_{i+1}(A)v = Q_m Aq_i(A_m)v.$$

Looking at the right-hand side we observe that $q_i(A_m)v$ belongs to \mathcal{K}_m . Hence,

$$q_{i+1}(A)v = Q_m A|_{\mathcal{K}_m} q_i(A_m)v = q_{i+1}(A_m)v,$$

which proves that the property is true for $i+1$, provided $i+1 \leq m-1$. For the case $i+1 = m$, it only remains to show that $Q_m q_m(A)v = q_m(A_m)v$, which follows from

$q_{m-1}(A)v = q_{m-1}(A_m)v$ by simply multiplying both sides by $Q_m A$. ■

ARNOLDI'S METHOD

6.3

Arnoldi's method [9] is an orthogonal projection method onto \mathcal{K}_m for general non-Hermitian matrices. The procedure was introduced in 1951 as a means of reducing a dense matrix into Hessenberg form. Arnoldi presented his method in this manner but hinted that the eigenvalues of the Hessenberg matrix obtained from a number of steps smaller than n could provide accurate approximations to some eigenvalues of the original matrix. It was later discovered that this strategy leads to an efficient technique for approximating eigenvalues of large sparse matrices. The method will first be described theoretically, i.e., assuming exact arithmetic, then implementation details will be addressed.

6.3.1 THE BASIC ALGORITHM

Arnoldi's procedure is an algorithm for building an orthogonal basis of the Krylov subspace \mathcal{K}_m . In exact arithmetic, one variant of the algorithm is as follows:

ALGORITHM 6.1: Arnoldi

1. Choose a vector v_1 of norm 1
 2. For $j = 1, 2, \dots, m$ Do:
 3. Compute $h_{ij} = (Av_j, v_i)$ for $i = 1, 2, \dots, j$
 4. Compute $w_j := Av_j - \sum_{i=1}^j h_{ij}v_i$
 5. $h_{j+1,j} = \|w_j\|_2$
 6. If $h_{j+1,j} = 0$ then Stop
 7. $v_{j+1} = w_j/h_{j+1,j}$
 8. EndDo
-

At each step, the algorithm multiplies the previous Arnoldi vector v_j by A and then orthonormalizes the resulting vector w_j against all previous v_i 's by a standard Gram-Schmidt procedure. It will stop if the vector w_j computed in line 4 vanishes. This case will be examined shortly. Now a few simple properties of the algorithm are proved.

PROPOSITION 6.4 Assume that Algorithm 6.1 does not stop before the m -th step. Then the vectors v_1, v_2, \dots, v_m form an orthonormal basis of the Krylov subspace

$$\mathcal{K}_m = \text{span}\{v_1, Av_1, \dots, A^{m-1}v_1\}.$$

Proof. The vectors $v_j, j = 1, 2, \dots, m$, are orthonormal by construction. That they span \mathcal{K}_m follows from the fact that each vector v_j is of the form $q_{j-1}(A)v_1$ where q_{j-1} is a polynomial of degree $j - 1$. This can be shown by induction on j as follows. The result is clearly true for $j = 1$, since $v_1 = q_0(A)v_1$ with $q_0(t) \equiv 1$. Assume that the result is true for all integers $\leq j$ and consider v_{j+1} . We have

$$h_{j+1}v_{j+1} = Av_j - \sum_{i=1}^j h_{ij}v_i = Aq_{j-1}(A)v_1 - \sum_{i=1}^j h_{ij}q_{i-1}(A)v_1 \quad (6.3)$$

which shows that v_{j+1} can be expressed as $q_j(A)v_1$ where q_j is of degree j and completes the proof. ■

PROPOSITION 6.5 Denote by V_m , the $n \times m$ matrix with column vectors v_1, \dots, v_m , by \bar{H}_m , the $(m + 1) \times m$ Hessenberg matrix whose nonzero entries h_{ij} are defined by Algorithm 6.1, and by H_m the matrix obtained from \bar{H}_m by deleting its last row. Then the following relations hold:

$$AV_m = V_m H_m + w_m e_m^T \quad (6.4)$$

$$= V_{m+1} \bar{H}_m, \quad (6.5)$$

$$V_m^T AV_m = H_m. \quad (6.6)$$

Proof. The relation (6.5) follows from the following equality which is readily derived from lines 4, 5, and 7 of Algorithm 6.1,

$$Av_j = \sum_{i=1}^{j+1} h_{ij}v_i, \quad j = 1, 2, \dots, m. \quad (6.7)$$

Relation (6.4) is a matrix reformulation of (6.7). Relation (6.6) follows by multiplying both sides of (6.4) by V_m^T and making use of the orthonormality of $\{v_1, \dots, v_m\}$. ■

The result of the proposition is illustrated in Figure 6.1.

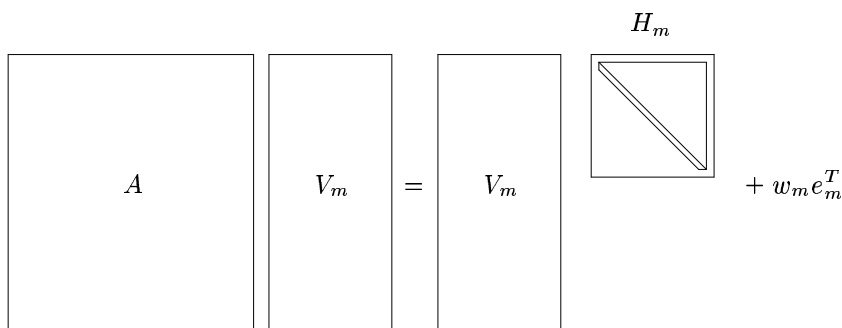

Figure 6.1 The action of A on V_m gives $V_m H_m$ plus a rank-one matrix.

As was noted earlier, the algorithm may break down in case the norm of w_j vanishes at a certain step j . In this case, the vector v_{j+1} cannot be computed and the algorithm stops.

Still to be determined are the conditions under which this situation occurs.

PROPOSITION 6.6 *Arnoldi's algorithm breaks down at step j (i.e., $h_{j+1,j} = 0$ in line 5 of Algorithm 6.1), if and only if the minimal polynomial of v_1 is of degree j . Moreover, in this case the subspace \mathcal{K}_j is invariant under A .*

Proof. If the degree of the minimal polynomial is j , then w_j must be equal to zero. Indeed, otherwise v_{j+1} can be defined and as a result \mathcal{K}_{j+1} would be of dimension $j + 1$. Then Proposition 6.2 would imply that $\mu \geq j + 1$, which is a contradiction. To prove the converse, assume that $w_j = 0$. Then the degree μ of the minimal polynomial of v_1 is such that $\mu \leq j$. Moreover, it is impossible that $\mu < j$. Otherwise, by the first part of this proof, the vector w_μ would be zero and the algorithm would have stopped at the earlier step number μ . The rest of the result follows from Proposition 6.1. ■

A corollary of the proposition is that a projection method onto the subspace \mathcal{K}_j will be exact when a breakdown occurs at step j . This result follows from Proposition 5.6 seen in Chapter 5. It is for this reason that such breakdowns are often called *lucky breakdowns*.

6.3.2 PRACTICAL IMPLEMENTATIONS

In the previous description of the Arnoldi process, exact arithmetic was assumed, mainly for simplicity. In practice, much can be gained by using the Modified Gram-Schmidt or the Householder algorithm instead of the standard Gram-Schmidt algorithm. With the Modified Gram-Schmidt alternative the algorithm takes the following form:

ALGORITHM 6.2: Arnoldi-Modified Gram-Schmidt

1. Choose a vector v_1 of norm 1
 2. For $j = 1, 2, \dots, m$ Do:
 3. Compute $w_j := Av_j$
 4. For $i = 1, \dots, j$ Do:
 5. $h_{ij} = (w_j, v_i)$
 6. $w_j := w_j - h_{ij}v_i$
 7. EndDo
 8. $h_{j+1,j} = \|w_j\|_2$. If $h_{j+1,j} = 0$ Stop
 9. $v_{j+1} = w_j/h_{j+1,j}$
 10. EndDo
-

In exact arithmetic, this algorithm and Algorithm 6.1 are mathematically equivalent. In the presence of round-off the above formulation is much more reliable. However, there are cases where cancellations are so severe in the orthogonalization steps that even the Modified Gram-Schmidt option is inadequate. In this case, two further improvements can be utilized.

The first improvement resorts to double orthogonalization. Whenever the final vector w_j obtained at the end of the main loop in the above algorithm has been computed, a

test is performed to compare its norm with the norm of the initial w_j (which is $\|Av_j\|_2$). If the reduction falls below a certain threshold, indicating severe cancellation might have occurred, a second orthogonalization is made. It is known from a result by Kahan that additional orthogonalizations are superfluous (see, for example, Parlett [160]).

The second improvement is to use a different technique altogether. From the numerical point of view, one of the most reliable orthogonalization techniques is the Householder algorithm. Recall from Chapter 1 that the Householder orthogonalization uses reflection matrices of the form $P_k = I - 2w_k w_k^T$ to transform a matrix X into upper triangular form. In the Arnoldi algorithm, the column vectors of the matrix X to be orthonormalized are not available ahead of time. Instead, the next vector is obtained as Av_j , where v_j is the current basis vector. In the Householder algorithm an orthogonal column v_i is obtained as $P_1 P_2 \dots P_i e_i$ where P_1, \dots, P_i are the previous Householder matrices. This vector is then multiplied by A and the previous Householder transforms are applied to it. Then, the next Householder transform is determined from the resulting vector. This procedure is described in the following algorithm, which was originally proposed by Walker [221].

ALGORITHM 6.3: Householder Arnoldi

1. Select a nonzero vector v ; Set $z_1 = v$
 2. For $j = 1, \dots, m, m + 1$ Do:
 3. Compute the Householder unit vector w_j such that
 4. $(w_j)_i = 0, i = 1, \dots, j - 1$ and
 5. $(P_j z_j)_i = 0, i = j + 1, \dots, n$, where $P_j = I - 2w_j w_j^T$
 6. $h_{j-1} = P_j z_j$
 7. $v_j = P_1 P_2 \dots P_j e_j$
 8. If $j \leq m$ compute $z_{j+1} := P_j P_{j-1} \dots P_1 Av_j$
 9. EndDo
-

For details regarding the determination of the Householder vector w_j in the third to fifth lines and on its use in the sixth to eight lines, see Chapter 1. Recall that the matrices P_j need not be formed explicitly. To obtain h_{j-1} from z_j in line 6, zero out all the components from position $j + 1$ through n of the n -vector z_j and change its j -th component, leaving all others unchanged. Thus, the $n \times m$ matrix $[h_0, h_1, \dots, h_m]$ will have the same structure as the matrix X_m of equation (1.22) in Chapter 1. By comparison with the Householder algorithm seen in Chapter 1, we can infer that the above process computes the QR factorization of the matrix $v, Av_1, Av_2, Av_3, \dots, Av_m$. Define

$$Q_j = P_j P_{j-1} \dots P_1. \quad (6.8)$$

The definition of z_{j+1} in line 8 of the algorithm yields the relation,

$$Q_j Av_j = z_{j+1}.$$

After the next Householder transformation P_{j+1} is applied in line 6, h_j satisfies the relation,

$$h_j = P_{j+1} z_{j+1} = P_{j+1} Q_j Av_j = Q_{j+1} Av_j. \quad (6.9)$$

Now observe that since the components $j + 2, \dots, n$ of h_j are zero, then $P_i h_j = h_j$ for any $i \geq j + 2$. Hence,

$$h_j = P_m P_{m-1} \dots P_{j+2} h_j = Q_m A v_j, \quad j = 1, \dots, m.$$

This leads to the factorization,

$$Q_m [v, A v_1, A v_2, \dots, A v_m] = [h_0, h_1, \dots, h_m] \quad (6.10)$$

where the matrix $[h_0, \dots, h_m]$ is $n \times (m + 1)$ and is upper triangular and Q_m is unitary.

It is important to relate the vectors v_i and h_i defined in this algorithm with vectors of the standard Arnoldi process. Let \bar{H}_m be the $(m + 1) \times m$ matrix obtained from the first $m + 1$ rows of the $n \times m$ matrix $[h_1, \dots, h_m]$. Since Q_{j+1} is unitary we have $Q_{j+1}^{-1} = Q_{j+1}^T$ and hence, from the relation (6.9)

$$A v_j = Q_{j+1}^T \sum_{i=1}^{j+1} h_{ij} e_i = \sum_{i=1}^{j+1} h_{ij} Q_{j+1}^T e_i$$

where each e_i is the i -th column of the $n \times n$ identity matrix. Since $P_k e_i = e_i$ for $i < k$, it is not difficult to see that

$$Q_{j+1}^T e_i = P_1 \dots P_{j+1} e_i = v_i, \quad \text{for } i \leq j + 1. \quad (6.11)$$

This yields the relation $A v_j = \sum_{i=1}^{j+1} h_{ij} v_i$, for $j = 1, \dots, m$, which can be written in matrix form as

$$A V_m = V_{m+1} \bar{H}_m.$$

This is identical with the relation (6.5) obtained with the Gram-Schmidt or Modified Gram-Schmidt implementation. The v_i 's form an orthonormal basis of the Krylov subspace \mathcal{K}_m and are identical with the v_i 's defined by the Arnoldi process, apart from a possible sign difference.

Although the Householder algorithm is numerically more viable than the Gram-Schmidt or Modified Gram-Schmidt versions, it is also more expensive. The cost of each of the outer loops, corresponding to the j control variable, is dominated by lines 7 and 8. These apply the reflection matrices P_i for $i = 1, \dots, j$ to a vector, perform the matrix-vector product $A v_j$, and then apply the matrices P_i for $i = j, j - 1, \dots, 1$ to a vector. The application of each P_i to a vector is performed as

$$(I - 2w_i w_i^T) v = v - \sigma w_i \quad \text{with } \sigma = 2w_i^T v.$$

This is essentially the result of a dot-product of length $n - i + 1$ followed by a vector update of the same length, requiring a total of about $4(n - i + 1)$ operations for each application of P_i . Neglecting the last step, the number of operations due to the Householder transformations alone approximately totals

$$\sum_{j=1}^m \sum_{i=1}^j 8(n - i + 1) = 8 \sum_{j=1}^m \left(jn - \frac{j(j-1)}{2} \right) \approx 4m^2 n - \frac{4}{3} m^3.$$

The table below shows the costs of different orthogonalization procedures. GS stands for Gram-Schmidt, MGS for Modified Gram-Schmidt, MGSR for Modified Gram-Schmidt with reorthogonalization, and HO for Householder.

	GS	MGS	MGSR	HO
Flops	$2m^2n$	$2m^2n$	$4m^2n$	$4m^2n - \frac{4}{3}m^3$
Storage	$(m+1)n$	$(m+1)n$	$(m+1)n$	$(m+1)n - \frac{1}{2}m^2$

The number of operations shown for MGSR corresponds to the worst case scenario when a second orthogonalization is performed each time. In practice, the number of operations is usually closer to that of the standard MGS. Regarding storage, the vectors $v_i, i = 1, \dots, m$ need not be saved. In the algorithms for solving linear systems, these vectors are needed at the end of the process. This issue will be covered with the Householder implementations of these algorithms. For now, assume that only the w_i 's are saved. The small gain in memory usage in the Householder version can be explained by the diminishing lengths of the vectors required at each step of the Householder transformation. However, this difference is negligible relative to the whole storage requirement of the algorithm, because $m \ll n$, typically.

The Householder orthogonalization may be a reasonable choice when developing general purpose, reliable software packages where robustness is a critical criterion. This is especially true for solving eigenvalue problems since the cost of orthogonalization is then amortized over several eigenvalue/eigenvector calculations. When solving linear systems, the Modified Gram-Schmidt orthogonalization, with a reorthogonalization strategy based on a measure of the level of cancellation, is more than adequate in most cases.

ARNOLDI'S METHOD FOR LINEAR SYSTEMS (FOM)

6.4

Given an initial guess x_0 to the original linear system $Ax = b$, we now consider an orthogonal *projection method* as defined in the previous chapter, which takes $\mathcal{L} = \mathcal{K} = \mathcal{K}_m(A, r_0)$, with

$$\mathcal{K}_m(A, r_0) = \text{span}\{r_0, Ar_0, A^2r_0, \dots, A^{m-1}r_0\}, \quad (6.12)$$

in which $r_0 = b - Ax_0$. This method seeks an approximate solution x_m from the affine subspace $x_0 + \mathcal{K}_m$ of dimension m by imposing the Galerkin condition

$$b - Ax_m \perp \mathcal{K}_m. \quad (6.13)$$

If $v_1 = r_0/\|r_0\|_2$ in Arnoldi's method, and set $\beta = \|r_0\|_2$, then

$$V_m^T AV_m = H_m$$

by (6.6) and

$$V_m^T r_0 = V_m^T (\beta v_1) = \beta e_1.$$

As a result, the approximate solution using the above m -dimensional subspaces is given by

$$x_m = x_0 + V_m y_m, \quad (6.14)$$

$$y_m = H_m^{-1}(\beta e_1). \quad (6.15)$$

A method based on this approach and called the Full Orthogonalization Method (FOM) is described next. Modified Gram-Schmidt is used in the Arnoldi step.

ALGORITHM 6.4: Full Orthogonalization Method (FOM)

1. Compute $r_0 = b - Ax_0$, $\beta := \|r_0\|_2$, and $v_1 := r_0/\beta$
 2. Define the $m \times m$ matrix $H_m = \{h_{ij}\}_{i,j=1,\dots,m}$; Set $H_m = 0$
 3. For $j = 1, 2, \dots, m$ Do:
 4. Compute $w_j := Av_j$
 5. For $i = 1, \dots, j$ Do:
 6. $h_{ij} = (w_j, v_i)$
 7. $w_j := w_j - h_{ij}v_i$
 8. EndDo
 9. Compute $h_{j+1,j} = \|w_j\|_2$. If $h_{j+1,j} = 0$ set $m := j$ and Goto 12
 10. Compute $v_{j+1} = w_j/h_{j+1,j}$.
 11. EndDo
 12. Compute $y_m = H_m^{-1}(\beta e_1)$ and $x_m = x_0 + V_m y_m$
-

The above algorithm depends on a parameter m which is the dimension of the Krylov subspace. In practice it is desirable to select m in a dynamic fashion. This would be possible if the residual norm of the solution x_m is available inexpensively (without having to compute x_m itself). Then the algorithm can be stopped at the appropriate step using this information. The following proposition gives a result in this direction.

PROPOSITION 6.7 *The residual vector of the approximate solution x_m computed by the FOM Algorithm is such that*

$$b - Ax_m = -h_{m+1,m} e_m^T y_m v_{m+1}$$

and, therefore,

$$\|b - Ax_m\|_2 = h_{m+1,m} |e_m^T y_m|. \quad (6.16)$$

Proof. We have the relations,

$$\begin{aligned} b - Ax_m &= b - A(x_0 + V_m y_m) \\ &= r_0 - AV_m y_m \\ &= \beta v_1 - V_m H_m y_m - h_{m+1,m} e_m^T y_m v_{m+1}. \end{aligned}$$

By the definition of y_m , $H_m y_m = \beta e_1$, and so $\beta v_1 - V_m H_m y_m = 0$ from which the result follows immediately. ■

A rough estimate of the cost of each step of the algorithm is determined as follows. If $Nz(A)$ is the number of nonzero elements of A , then m steps of the Arnoldi procedure will require m matrix-vector products at the cost of $2m \times Nz(A)$. Each of the Gram-Schmidt steps costs approximately $4 \times j \times n$ operations, which brings the total over the m steps to

approximately $2m^2n$. Thus, on the average, a step of FOM costs approximately

$$2Nz(A) + 2mn.$$

Regarding storage, m vectors of length n are required to save the basis V_m . Additional vectors must be used to keep the current solution and right-hand side, and a scratch vector for the matrix-vector product. In addition, the Hessenberg matrix H_m must be saved. The total is therefore roughly

$$(m + 3)n + \frac{m^2}{2}.$$

In most situations m is small relative to n , so this cost is dominated by the first term.

6.4.1 VARIATION 1: RESTARTED FOM

Consider now the algorithm from a practical viewpoint. As m increases, the computational cost increases at least as $O(m^2)n$ because of the Gram-Schmidt orthogonalization. The memory cost increases as $O(mn)$. For large n this limits the largest value of m that can be used. There are two remedies. The first is to restart the algorithm periodically and the second is to “truncate” the orthogonalization in the Arnoldi algorithm. In this section we consider the first of these two options, which is described below.

ALGORITHM 6.5: Restarted FOM (FOM(m))

1. Compute $r_0 = b - Ax_0$, $\beta = \|r_0\|_2$, and $v_1 = r_0/\beta$.
 2. Generate the Arnoldi basis and the matrix H_m using the Arnoldi algorithm
 3. starting with v_1 .
 4. Compute $y_m = H_m^{-1}\beta e_1$ and $x_m = x_0 + V_m y_m$. If satisfied then Stop.
 5. Set $x_0 := x_m$ and go to 1.
-

There are many possible variations to this basic scheme. One that is generally more economical in practice is based on the observation that sometimes a small m is sufficient for convergence and sometimes the largest possible m is necessary. Hence, the idea of averaging over different values of m . Start the algorithm with $m = 1$ and increment m by one in line 5 until a certain m_{max} is reached, after which m is reset to one, or kept the same. These variations will not be considered here.

Example 6.1 Table 6.1 shows the results of applying the FOM algorithm with no preconditioning to three of the test problems described in Section 3.7.

Matrix	Iters	Kflops	Residual	Error
F2DA	109	4442	0.36E-03	0.67E-04
F3D	66	11664	0.87E-03	0.35E-03
ORS	300	13558	0.26E+00	0.71E-04

Table 6.1 *A test run of FOM with no preconditioning.*

The column labeled *Iters* shows the total actual number of matrix-vector multiplications (matvecs) required to converge. The stopping criterion used is that the 2-norm of the residual be reduced by a factor of 10^7 relative to the 2-norm of the initial residual. A maximum of 300 matvecs are allowed. *Kflops* is the total number of floating point operations performed, in thousands. *Residual* and *Error* represent the two-norm of the residual and error vectors, respectively. In this test, m was taken to be 10. Note that the method did not succeed in solving the third problem.

6.4.2 VARIATION 2: IOM AND DIOM

A second alternative to FOM is to truncate the Arnoldi recurrence. Specifically, an integer k is selected and the following “incomplete” orthogonalization is performed.

ALGORITHM 6.6: Incomplete Orthogonalization Process

1. For $j = 1, 2, \dots, m$ Do:
 2. Compute $w := Av_j$
 3. For $i = \max\{1, j - k + 1\}, \dots, j$ Do:
 4. $h_{i,j} = (w, v_i)$
 5. $w := w - h_{ij}v_i$
 6. EndDo
 7. Compute $h_{j+1,j} = \|w\|_2$ and $v_{j+1} = w/h_{j+1,j}$
 8. EndDo
-

The number of directions k against which to orthogonalize may be dictated by memory limitations. The Incomplete Orthogonalization Method (IOM) consists of performing the above incomplete orthogonalization procedure and computing an approximate solution using the same formulas (6.14) and (6.15).

ALGORITHM 6.7: IOM Algorithm

Run a modification of Algorithm 6.4 in which the Arnoldi process in lines 3 to 11 is replaced by the Incomplete Orthogonalization process and every other computation remains unchanged.

It is now necessary to keep only the k previous v_i vectors. The others are not needed in the above process and may be discarded. However, the difficulty remains that when the solution is computed by formula (6.14), all the vectors v_i for $i = 1, 2, \dots, m$ are required. One option is to recompute them at the end, but essentially this doubles the cost of the algorithm. Fortunately, a formula can be developed whereby the current approximate solution x_m can be updated from the previous approximation x_{m-1} and a small number

of vectors that are also updated at each step. This *progressive* formulation of the solution leads to an algorithm termed *Direct IOM* (DIOM) which we now derive.

The Hessenberg matrix H_m obtained from the incomplete orthogonalization process has a band structure with a bandwidth of $k + 1$. For example, when $k = 3$ and $m = 5$, it is of the form

$$H_m = \begin{pmatrix} h_{11} & h_{12} & h_{13} & & \\ h_{21} & h_{22} & h_{23} & h_{24} & \\ & h_{32} & h_{33} & h_{34} & h_{35} \\ & & h_{43} & h_{44} & h_{45} \\ & & & h_{54} & h_{55} \end{pmatrix}. \quad (6.17)$$

The *Direct* version of IOM is derived from exploiting the special structure of the LU factorization, $H_m = L_m U_m$, of the matrix H_m . Assuming no pivoting is used, the matrix L_m is unit lower bidiagonal and U_m is banded upper triangular, with k diagonals. Thus, the above matrix has a factorization of the form

$$H_m = \begin{pmatrix} 1 & & & & \\ l_{21} & 1 & & & \\ & l_{32} & 1 & & \\ & & l_{43} & 1 & \\ & & & l_{54} & 1 \end{pmatrix} \times \begin{pmatrix} u_{11} & u_{12} & u_{13} & & \\ & u_{22} & u_{23} & u_{24} & \\ & & u_{33} & u_{34} & u_{35} \\ & & & u_{44} & u_{45} \\ & & & & u_{55} \end{pmatrix}.$$

The approximate solution is then given by

$$x_m = x_0 + V_m U_m^{-1} L_m^{-1} (\beta e_1).$$

Defining

$$P_m \equiv V_m U_m^{-1}$$

and

$$z_m = L_m^{-1} (\beta e_1),$$

the approximate solution is given by

$$x_m = x_0 + P_m z_m. \quad (6.18)$$

Because of the structure of U_m , P_m can be updated easily. Indeed, equating the last columns of the matrix relation $P_m U_m = V_m$ yields

$$\sum_{i=m-k+1}^m u_{im} p_i = v_m,$$

which allows the vector p_m to be computed from the previous p_i 's and v_m , with the help of the relation,

$$p_m = \frac{1}{u_{mm}} \left[v_m - \sum_{i=m-k+1}^{m-1} u_{im} p_i \right].$$

In addition, because of the structure of L_m , we have the relation

$$z_m = \begin{bmatrix} z_{m-1} \\ \zeta_m \end{bmatrix}$$

in which

$$\zeta_m = -l_{m,m-1}\zeta_{m-1}.$$

From (6.18),

$$x_m = x_0 + [P_{m-1}, p_m] \begin{bmatrix} z_{m-1} \\ \zeta_m \end{bmatrix} = x_0 + P_{m-1}z_{m-1} + \zeta_m p_m.$$

Noting that $x_0 + P_{m-1}z_{m-1} = x_{m-1}$, it follows that the approximation x_m can be updated at each step by the relation,

$$x_m = x_{m-1} + \zeta_m p_m$$

where p_m is defined above. This gives the following algorithm, called the Direct Incomplete Orthogonalization Method (DIOM).

ALGORITHM 6.8: DIOM

1. Choose x_0 and compute $r_0 = b - Ax_0$, $\beta := \|r_0\|_2$, $v_1 := r_0/\beta$.
 2. For $m = 1, 2, \dots$, until convergence Do:
 3. Compute h_{im} , $i = \max\{1, m - k + 1\}, \dots, m$ and v_{m+1} as in
 4. lines 2-7 of Algorithm (6.6).
 5. Update the LU factorization of H_m , i.e., obtain the last column
 6. of U_m using the previous k pivots. If $u_{mm} = 0$ Stop.
 7. $\zeta_m = \{ \text{if } m = 1 \text{ then } \beta, \text{ else } -l_{m,m-1} \zeta_{m-1} \}$
 8. $p_m = u_{mm}^{-1} \left(v_m - \sum_{i=m-k+1}^{m-1} u_{im} p_i \right)$ (for $i \leq 0$ set $u_{im} p_i \equiv 0$)
 9. $x_m = x_{m-1} + \zeta_m p_m$
 10. EndDo
-

Note that the above algorithm is based implicitly on Gaussian elimination without pivoting for the solution of the Hessenberg system $H_m y_m = \beta e_1$. This may cause a premature termination in line 6. Fortunately, there is an implementation based on Gaussian elimination with partial pivoting. The details of this variant can be found in [174]. DIOM can also be derived by imposing the properties that are satisfied by the residual vector and the conjugate directions, i.e., the p_i 's.

Observe that (6.4) is still valid and as a consequence, Proposition 6.7, which is based on it, still holds. That is because the orthogonality properties were not used to derive the two relations therein. Since the residual vector is a scalar multiple of v_{m+1} and since the v_i 's are no longer orthogonal, IOM and DIOM are not orthogonal projection techniques. They can, however, be viewed as oblique projection techniques onto \mathcal{K}_m and orthogonal to an artificially constructed subspace.

PROPOSITION 6.8 *IOM and DIOM are mathematically equivalent to a projection process onto \mathcal{K}_m and orthogonally to*

$$\mathcal{L}_m = \text{span}\{z_1, z_2, \dots, z_m\}$$

where

$$z_i = v_i - (v_i, v_{m+1})v_{m+1}, \quad i = 1, \dots, m.$$

Proof. The proof is an immediate consequence of the fact that r_m is a multiple of v_{m+1} and by construction, v_{m+1} is orthogonal to all z_i 's defined in the proposition. ■

The following simple properties can be shown:

- The residual vectors r_i , $i = 1, \dots, m$, are “locally” orthogonal,

$$(r_j, r_i) = 0, \quad \text{for } |i - j| \leq k, \quad i \neq j.$$

- The p_j 's are locally A -orthogonal to the Arnoldi vectors, i.e.,

$$(Ap_j, v_i) = 0 \quad \text{for } j - k + 1 < i < j.$$

- For the case $k = \infty$ (full orthogonalization) the p_j 's are semi-conjugate, i.e.,

$$(Ap_j, p_i) = 0 \quad \text{for } i < j.$$

GMRES

6.5

The Generalized Minimum Residual Method (GMRES) is a projection method based on taking $\mathcal{K} = \mathcal{K}_m$ and $\mathcal{L} = A\mathcal{K}_m$, in which \mathcal{K}_m is the m -th Krylov subspace with $v_1 = r_0/\|r_0\|_2$. As seen in Chapter 5, such a technique minimizes the residual norm over all vectors in $x_0 + \mathcal{K}_m$. The implementation of an algorithm based on this approach is similar to that of the FOM algorithm. We first describe the basic idea and then discuss a few practical variations.

6.5.1 THE BASIC GMRES ALGORITHM

There are two ways to derive the algorithm. The first way exploits the optimality property and the relation (6.5). Any vector x in $x_0 + \mathcal{K}_m$ can be written as

$$x = x_0 + V_m y, \quad (6.19)$$

where y is an m -vector. Defining

$$J(y) = \|b - Ax\|_2 = \|b - A(x_0 + V_m y)\|_2, \quad (6.20)$$

the relation (6.5) results in

$$\begin{aligned} b - Ax &= b - A(x_0 + V_m y) \\ &= r_0 - AV_m y \\ &= \beta v_1 - V_{m+1} \bar{H}_m y \\ &= V_{m+1} (\beta e_1 - \bar{H}_m y). \end{aligned} \quad (6.21)$$

Since the column-vectors of V_{m+1} are orthonormal, then

$$J(y) \equiv \|b - A(x_0 + V_m y)\|_2 = \|\beta e_1 - \bar{H}_m y\|_2. \quad (6.22)$$

The GMRES approximation is the unique vector of $x_0 + \mathcal{K}_m$ which minimizes (6.20). By (6.19) and (6.22), this approximation can be obtained quite simply as $x_m = x_0 + V_m y_m$ where y_m minimizes the function $J(y) = \|\beta e_1 - \bar{H}_m y\|_2$, i.e.,

$$x_m = x_0 + V_m y_m, \quad \text{where} \quad (6.23)$$

$$y_m = \operatorname{argmin}_y \|\beta e_1 - \bar{H}_m y\|_2. \quad (6.24)$$

The minimizer y_m is inexpensive to compute since it requires the solution of an $(m+1) \times m$ least-squares problem where m is typically small. This gives the following algorithm.

ALGORITHM 6.9: GMRES

1. Compute $r_0 = b - Ax_0$, $\beta := \|r_0\|_2$, and $v_1 := r_0/\beta$
 2. Define the $(m+1) \times m$ matrix $\bar{H}_m = \{h_{ij}\}_{1 \leq i \leq m+1, 1 \leq j \leq m}$. Set $\bar{H}_m = 0$.
 3. For $j = 1, 2, \dots, m$ Do:
 4. Compute $w_j := Av_j$
 5. For $i = 1, \dots, j$ Do:
 6. $h_{ij} := (w_j, v_i)$
 7. $w_j := w_j - h_{ij}v_i$
 8. EndDo
 9. $h_{j+1,j} = \|w_j\|_2$. If $h_{j+1,j} = 0$ set $m := j$ and go to 12
 10. $v_{j+1} = w_j/h_{j+1,j}$
 11. EndDo
 12. Compute y_m the minimizer of $\|\beta e_1 - \bar{H}_m y\|_2$ and $x_m = x_0 + V_m y_m$.
-

The second way to derive the GMRES algorithm is to use the equations (5.7) with $W_m = AV_m$. This is the subject of Exercise 4.

6.5.2 THE HOUSEHOLDER VERSION

The previous algorithm utilizes the Modified Gram-Schmidt orthogonalization in the Arnoldi process. Section 6.3.2 described a Householder variant of the Arnoldi process which is numerically more robust than Gram-Schmidt. Here, we focus on a modification of GMRES which retrofits the Householder orthogonalization. Section 6.3.2 explained how to get the v_j and the columns of \bar{H}_{m+1} at each step, from the Householder-Arnoldi algorithm. Since V_m and \bar{H}_m are the only items needed to extract the approximate solution at the end of the GMRES process, the modification seems rather straightforward. However, this is only true if the v_i 's are stored. In this case, line 12 would remain the same and the modification to the algorithm would be in lines 3-11 which are to be replaced by the Householder variant of the Arnoldi process. It was mentioned in Section 6.3.2 that it is preferable not to store the v_i 's because this would double the storage requirement. In this case, a formula must be found to generate the approximate solution in line 12, using only the w_i 's, i.e., the P_i 's. Let

$$y_m = (\eta_1, \eta_2, \dots, \eta_m)^T,$$

so that the solution is of the form $x_m = x_0 + \eta_1 v_1 + \dots + \eta_m v_m$. Recall that in the Householder variant of the Arnoldi process, each v_j is defined by

$$v_j = P_1 P_2 \dots P_j e_j.$$

Using a Horner-like scheme, we obtain

$$\begin{aligned} x_m &= x_0 + \eta_1 P_1 e_1 + \eta_2 P_1 P_2 e_2 + \dots + \eta_m P_1 P_2 \dots P_m e_m \\ &= x_0 + P_1 (\eta_1 e_1 + P_2 (\eta_2 e_2 + \dots + P_{m-1} (\eta_{m-1} e_{m-1} + P_m \eta_m e_m))). \end{aligned}$$

Therefore, when Householder orthogonalization is used, then line 12 of the GMRES algorithm should be replaced by a step of the form

$$z := 0 \tag{6.25}$$

$$z := P_j (\eta_j e_j + z), j = m, m-1, \dots, 1 \tag{6.26}$$

$$x_m = x_0 + z. \tag{6.27}$$

The above step requires roughly as many operations as computing the last Arnoldi vector v_m . Therefore, its cost is negligible relative to the cost of the Arnoldi loop.

ALGORITHM 6.10: GMRES with Householder orthogonalization

1. Compute $r_0 = b - Ax_0$, $z := r_0$.
 2. For $j = 1, \dots, m, m+1$ Do:
 3. Compute the Householder unit vector w_j such that
 4. $(w_j)_i = 0, i = 1, \dots, j-1$ and
 5. $(P_j z)_i = 0, i = j+1, \dots, n$ where $P_j = I - 2w_j w_j^T$;
 6. $h_{j-1} := P_j z$; If $j = 1$ then let $\beta := e_1^T h_0$.
 7. $v := P_1 P_2 \dots P_j e_j$.
 8. If $j \leq m$ compute $z := P_j P_{j-1} \dots P_1 A v$,
 9. EndDo
 10. Define \bar{H}_m = the $(m+1) \times m$ upper part of the matrix $[h_1, \dots, h_m]$.
 11. Compute $y_m = \text{Argmin}_y \|\beta e_1 - \bar{H}_m y\|_2$. Let $y_m = (\eta_1, \eta_2, \dots, \eta_m)^T$.
 12. $z := 0$
 13. For $j = m, m-1, \dots, 1$ Do:
 14. $z := P_j (\eta_j e_j + z)$,
 15. EndDo
 16. Compute $x_m = x_0 + z$
-

Note that now only the set of w_j vectors needs to be saved. The scalar β defined in line 6 is equal to $\pm \|r_0\|_2$. This is because $P_1 z = \beta e_1$ where β is defined by the equations (1.21) seen in Chapter 1, which define the first Householder transformation. As was observed earlier the Householder factorization actually obtains the QR factorization (6.10) with $v = r_0$. We can also formulate GMRES directly from this factorization. Indeed, if $x = x_0 + V_m y_m$, then according to this factorization, the corresponding residual norm is equal to

$$\|h_0 - \eta_1 h_1 - \eta_2 h_2 - \dots - \eta_m h_m\|_2$$

whose minimizer is the same as the one defined by the algorithm.

The details of implementation of the solution of the least-squares problem as well as the estimate of the residual norm are identical with those of the Gram-Schmidt versions and are discussed next.

6.5.3 PRACTICAL IMPLEMENTATION ISSUES

A clear difficulty with Algorithm 6.9 is that it does not provide the approximate solution x_m explicitly at each step. As a result, it is not easy to determine when to stop. One remedy is to compute the approximation solution x_m at regular intervals and check for convergence by a test on the residual, for example. However, there is a more elegant solution which is related to the way in which the least-squares problem (6.24) is solved.

In order to solve the least-squares problem $\min \|\beta e_1 - \bar{H}_m y\|$, it is natural to transform the Hessenberg matrix into upper triangular form by using plane rotations. Define the rotation matrices

$$\Omega_i = \begin{pmatrix} 1 & & & & & & \\ & \ddots & & & & & \\ & & 1 & & & & \\ & & & c_i & s_i & & \\ & & & -s_i & c_i & & \\ & & & & & 1 & \\ & & & & & & \ddots \\ & & & & & & & 1 \end{pmatrix} \begin{matrix} \leftarrow \text{row } i \\ \leftarrow \text{row } i + 1 \end{matrix} \quad (6.28)$$

with $c_i^2 + s_i^2 = 1$. If m steps of the GMRES iteration are performed then these matrices have dimension $(m + 1) \times (m + 1)$.

Multiply the Hessenberg matrix \bar{H}_m and the corresponding right-hand side $\bar{g}_0 \equiv \beta e_1$ by a sequence of such matrices from the left. The coefficients s_i, c_i are selected to eliminate $h_{i+1,i}$ at each time. Thus, if $m = 5$ we would have

$$\bar{H}_5 = \begin{pmatrix} h_{11} & h_{12} & h_{13} & h_{14} & h_{15} \\ h_{21} & h_{22} & h_{23} & h_{24} & h_{25} \\ & h_{32} & h_{33} & h_{34} & h_{35} \\ & & h_{43} & h_{44} & h_{45} \\ & & & h_{54} & h_{55} \\ & & & & h_{65} \end{pmatrix}, \quad \bar{g}_0 = \begin{pmatrix} \beta \\ 0 \\ 0 \\ 0 \\ 0 \\ 0 \end{pmatrix}.$$

Then premultiply \bar{H}_5 by

$$\Omega_1 = \begin{pmatrix} c_1 & s_1 & & & \\ -s_1 & c_1 & & & \\ & & 1 & & \\ & & & 1 & \\ & & & & 1 \end{pmatrix}$$

with

$$s_1 = \frac{h_{21}}{\sqrt{h_{11}^2 + h_{21}^2}}, \quad c_1 = \frac{h_{11}}{\sqrt{h_{11}^2 + h_{21}^2}}$$

to obtain the matrix and right-hand side

$$\bar{H}_5^{(1)} = \begin{pmatrix} h_{11}^{(1)} & h_{12}^{(1)} & h_{13}^{(1)} & h_{14}^{(1)} & h_{15}^{(1)} \\ & h_{22}^{(1)} & h_{23}^{(1)} & h_{24}^{(1)} & h_{25}^{(1)} \\ & & h_{33} & h_{34} & h_{35} \\ & & & h_{44} & h_{45} \\ & & & & h_{54} & h_{55} \\ & & & & & h_{65} \end{pmatrix}, \quad \bar{g}_1 = \begin{pmatrix} c_1\beta \\ -s_1\beta \\ 0 \\ 0 \\ 0 \\ 0 \end{pmatrix}. \quad (6.29)$$

We can now premultiply the above matrix and right-hand side again by a rotation matrix Ω_2 to eliminate h_{32} . This is achieved by taking

$$s_2 = \frac{h_{32}}{\sqrt{(h_{22}^{(1)})^2 + h_{32}^2}}, \quad c_2 = \frac{h_{22}^{(1)}}{\sqrt{(h_{22}^{(1)})^2 + h_{32}^2}}.$$

This elimination process is continued until the m -th rotation is applied, which transforms the problem into one involving the matrix and right-hand side,

$$\bar{H}_5^{(5)} = \begin{pmatrix} h_{11}^{(5)} & h_{12}^{(5)} & h_{13}^{(5)} & h_{14}^{(5)} & h_{15}^{(5)} \\ & h_{22}^{(5)} & h_{23}^{(5)} & h_{24}^{(5)} & h_{25}^{(5)} \\ & & h_{33}^{(5)} & h_{34}^{(5)} & h_{35}^{(5)} \\ & & & h_{44}^{(5)} & h_{45}^{(5)} \\ & & & & h_{55}^{(5)} \\ & & & & & 0 \end{pmatrix}, \quad \bar{g}_5 = \begin{pmatrix} \gamma_1 \\ \gamma_2 \\ \gamma_3 \\ \cdot \\ \cdot \\ \gamma_6 \end{pmatrix}. \quad (6.30)$$

Generally, the scalars c_i and s_i of the i^{th} rotation Ω_i are defined as

$$s_i = \frac{h_{i+1,i}}{\sqrt{(h_{ii}^{(i-1)})^2 + h_{i+1,i}^2}}, \quad c_i = \frac{h_{ii}^{(i-1)}}{\sqrt{(h_{ii}^{(i-1)})^2 + h_{i+1,i}^2}}. \quad (6.31)$$

Define Q_m the product of matrices Ω_i ,

$$Q_m = \Omega_m \Omega_{m-1} \dots \Omega_1 \quad (6.32)$$

and

$$\bar{R}_m = \bar{H}_m^{(m)} = Q_m \bar{H}_m, \quad (6.33)$$

$$\bar{g}_m = Q_m(\beta e_1) = (\gamma_1, \dots, \gamma_{m+1})^T. \quad (6.34)$$

Since Q_m is unitary,

$$\min \|\beta e_1 - \bar{H}_m y\|_2 = \min \|\bar{g}_m - \bar{R}_m y\|_2.$$

The solution to the above least-squares problem is obtained by simply solving the triangular system resulting from deleting the last row of the matrix \bar{R}_m and right-hand side \bar{g}_m in (6.30). In addition, it is clear that for the solution y_* , the “residual” $\|\beta e_1 - \bar{H}_m y_*\|$ is nothing but the last element of the right-hand side, i.e., the term γ_6 in the above illustration.

PROPOSITION 6.9 *Let $\Omega_i, i = 1, \dots, m$ be the rotation matrices used to transform \bar{H}_m into an upper triangular form and $\bar{R}_m, \bar{g}_m = (\gamma_1, \dots, \gamma_{m+1})^T$ the resulting matrix and right-hand side, as defined by (6.33), (6.34). Denote by R_m the $m \times m$ upper triangular*

matrix obtained from \bar{R}_m by deleting its last row and by g_m the m -dimensional vector obtained from \bar{g}_m by deleting its last component. Then,

1. The rank of AV_m is equal to the rank of R_m . In particular, if $r_{mm} = 0$ then A must be singular.
2. The vector y_m which minimizes $\|\beta e_1 - \bar{H}_m y\|_2$ is given by

$$y_m = R_m^{-1} g_m.$$

3. The residual vector at step m satisfies

$$b - Ax_m = V_{m+1} (\beta e_1 - \bar{H}_m y_m) = V_{m+1} Q_m^T (\gamma_{m+1} e_{m+1}) \quad (6.35)$$

and, as a result,

$$\|b - Ax_m\|_2 = |\gamma_{m+1}|. \quad (6.36)$$

Proof. To prove first part (1), use (6.5), to obtain the relation

$$\begin{aligned} AV_m &= V_{m+1} \bar{H}_m \\ &= V_{m+1} Q_m^T Q_m \bar{H}_m \\ &= V_{m+1} Q_m^T \bar{R}_m. \end{aligned}$$

Since $V_{m+1} Q_m^T$ is unitary, the rank of AV_m is that of \bar{R}_m , which equals the rank of R_m since these two matrices differ only by a zero row (the last row of \bar{R}_m). If $r_{mm} = 0$ then R_m is of rank $\leq m - 1$ and as a result AV_m is also of rank $\leq m - 1$. Since V_m is of full rank, this means that A must be singular.

The second part (2), was essentially proved before the proposition. For any vector y ,

$$\begin{aligned} \|\beta e_1 - \bar{H}_m y\|_2^2 &= \|Q_m (\beta e_1 - \bar{H}_m y)\|_2^2 \\ &= \|\bar{g}_m - \bar{R}_m y\|_2^2 \\ &= |\gamma_{m+1}|^2 + \|g_m - R_m y\|_2^2 \end{aligned} \quad (6.37)$$

The minimum of the left-hand side is reached when the second term in the right-hand side of (6.37) is zero. Since R_m is nonsingular, this is achieved when $y = R_m^{-1} g_m$.

To prove the third part (3), we start with the definitions used for GMRES and the relation (6.21). For any $x = x_0 + V_m y$,

$$\begin{aligned} b - Ax &= V_{m+1} (\beta e_1 - \bar{H}_m y) \\ &= V_{m+1} Q_m^T Q_m (\beta e_1 - \bar{H}_m y) \\ &= V_{m+1} Q_m^T (\bar{g}_m - \bar{R}_m y). \end{aligned}$$

As was seen in the proof of the second part above, the 2-norm of $\bar{g}_m - \bar{R}_m y$ is minimized when y annihilates all components of the right-hand side \bar{g}_m except the last one, which is equal to γ_{m+1} . As a result,

$$b - Ax_m = V_{m+1} Q_m^T (\gamma_{m+1} e_{m+1})$$

which is (6.35). The result (6.36) follows from the orthonormality of the column-vectors of $V_{m+1} Q_m^T$. ■

So far we have only described a process for computing the least-squares solution y_m

of (6.24). Note that this approach with plane rotations can also be used to solve the linear system (6.15) for the FOM method. The only difference is that the last rotation Ω_m must be omitted. In particular, a single program can be written to implement both algorithms using a switch for selecting the FOM or GMRES options.

It is possible to implement the above process in a progressive manner, i.e., at each step of the GMRES algorithm. This approach will allow one to obtain the residual norm at every step, with virtually no additional arithmetic operations. To illustrate this, start with (6.30), i.e., assume that the first m rotations have already been applied. Now the residual norm is available for x_5 and the stopping criterion can be applied. Assume that the test dictates that further steps be taken. One more step of the Arnoldi algorithm must be executed to get Av_6 and the 6-th column of \tilde{H}_6 . This column is appended to \tilde{R}_5 which has been augmented by a zero row to match the dimension. Then the previous rotations $\Omega_1, \Omega_2, \dots, \Omega_5$ are applied to this last column. After this is done the following matrix and right-hand side are obtained:

$$H_6^{(5)} = \begin{pmatrix} h_{11}^{(5)} & h_{12}^{(5)} & h_{13}^{(5)} & h_{14}^{(5)} & h_{15}^{(5)} & h_{16}^{(5)} \\ & h_{22}^{(5)} & h_{23}^{(5)} & h_{24}^{(5)} & h_{25}^{(5)} & h_{26}^{(5)} \\ & & h_{33}^{(5)} & h_{34}^{(5)} & h_{35}^{(5)} & h_{36}^{(5)} \\ & & & h_{44}^{(5)} & h_{45}^{(5)} & h_{46}^{(5)} \\ & & & & h_{55}^{(5)} & h_{56}^{(5)} \\ & & & & 0 & h_{66}^{(5)} \\ & & & & 0 & h_{76}^{(5)} \end{pmatrix}, \quad g_6^{(5)} = \begin{pmatrix} \gamma_1 \\ \gamma_2 \\ \gamma_3 \\ \cdot \\ \cdot \\ \gamma_6 \\ 0 \end{pmatrix}. \quad (6.38)$$

The algorithm now continues in the same way as before. We need to premultiply the matrix by a rotation matrix Ω_6 (now of size 7×7) with

$$s_6 = \frac{h_{76}}{\sqrt{(h_{66}^{(5)})^2 + h_{76}^2}}, \quad c_6 = \frac{h_{66}^{(5)}}{\sqrt{(h_{66}^{(5)})^2 + h_{76}^2}}$$

to get the matrix and right-hand side,

$$\tilde{R}_6 = \begin{pmatrix} r_{11} & r_{12} & r_{13} & r_{14} & r_{15} & r_{16} \\ & r_{22} & r_{23} & r_{24} & r_{25} & r_{26} \\ & & r_{33} & r_{34} & r_{35} & r_{36} \\ & & & r_{44} & r_{45} & r_{46} \\ & & & & r_{55} & r_{56} \\ & & & & & r_{66} \\ & & & & & 0 \end{pmatrix}, \quad \bar{g}_6 = \begin{pmatrix} \gamma_1 \\ \gamma_2 \\ \gamma_3 \\ \cdot \\ \cdot \\ c_6 \gamma_6 \\ -s_6 \gamma_6 \end{pmatrix}. \quad (6.39)$$

If the residual norm as given by $|\gamma_{m+1}|$ is small enough, the process must be stopped. The last rows of \tilde{R}_m and \bar{g}_m are deleted and the resulting upper triangular system is solved to obtain y_m . Then the approximate solution $x_m = x_0 + V_m y_m$ is computed.

Note from (6.39) that the following useful relation for γ_{j+1} results

$$\gamma_{j+1} = -s_j \gamma_j. \quad (6.40)$$

In particular, if $s_j = 0$ then the residual norm must be equal to zero which means that the solution is exact at step j .

6.5.4 BREAKDOWN OF GMRES

If Algorithm 6.9 is examined carefully, we observe that the only possibilities of breakdown in GMRES are in the Arnoldi loop, when $\hat{v}_{j+1} = 0$, i.e., when $h_{j+1,j} = 0$ at a given step j . In this situation, the algorithm stops because the next Arnoldi vector cannot be generated. However, in this situation, the residual vector is zero, i.e., the algorithm will deliver the exact solution at this step. In fact, the converse is also true: If the algorithm stops at step j with $b - Ax_j = 0$, then $h_{j+1,j} = 0$.

PROPOSITION 6.10 *Let A be a nonsingular matrix. Then, the GMRES algorithm breaks down at step j , i.e., $h_{j+1,j} = 0$, if and only if the approximate solution x_j is exact.*

Proof. To show the necessary condition, observe that if $h_{j+1,j} = 0$, then $s_j = 0$. Indeed, since A is nonsingular, then $r_{jj} = h_{jj}^{(j-1)}$ is nonzero by the first part of Proposition 6.9 and (6.31) implies $s_j = 0$. Then, the relations (6.36) and (6.40) imply that $r_j = 0$.

To show the sufficient condition, we use (6.40) again. Since the solution is exact at step j and not at step $j - 1$, then $s_j = 0$. From the formula (6.31), this implies that $h_{j+1,j} = 0$. ■

6.5.5 RELATIONS BETWEEN FOM AND GMRES

If the last row of the least-squares system in (6.38) is deleted, instead of the one in (6.39), i.e., before the last rotation Ω_δ is applied, the same approximate solution as FOM would result. As a practical consequence a single subroutine can be written to handle both cases. This observation can also be helpful in understanding the relationships between the two algorithms.

We begin by establishing an interesting relation between the FOM and GMRES iterates, which will be exploited in the next chapter. A general lemma is first shown regarding the solutions of the triangular systems

$$R_m y_m = g_m$$

obtained from applying successive rotations to the Hessenberg matrices \bar{H}_m . As was stated before, the only difference between the y_m vectors obtained in GMRES and Arnoldi is that the last rotation Ω_m is omitted in FOM. In other words, the R_m matrix for the two methods differs only in its (m, m) entry while the right-hand sides differ only in their last components.

LEMMA 6.1 *Let \tilde{R}_m be the $m \times m$ upper part of the matrix $Q_{m-1} \bar{H}_m$ and, as before, let R_m be the $m \times m$ upper part of the matrix $Q_m \bar{H}_m$. Similarly, let \tilde{g}_m be the vector of the first m components of $Q_{m-1}(\beta e_1)$ and let g_m be the vector of the first m components of $Q_m(\beta e_1)$. Define*

$$\tilde{y}_m = \tilde{R}_m^{-1} \tilde{g}_m, \quad y_m = R_m^{-1} g_m$$

the y vectors obtained for an m -dimensional FOM and GMRES methods, respectively.

Then

$$y_m - \begin{pmatrix} y_{m-1} \\ 0 \end{pmatrix} = c_m^2 \left(\tilde{y}_m - \begin{pmatrix} y_{m-1} \\ 0 \end{pmatrix} \right) \quad (6.41)$$

in which c_m is the cosine used in the m -th rotation Ω_m , as defined by (6.31).

Proof. The following relation holds:

$$R_m = \begin{pmatrix} R_{m-1} & z_m \\ 0 & \xi_m \end{pmatrix}, \quad \tilde{R}_m = \begin{pmatrix} R_{m-1} & z_m \\ 0 & \tilde{\xi}_m \end{pmatrix}.$$

Similarly, for the right-hand sides,

$$g_m = \begin{pmatrix} g_{m-1} \\ \gamma_m \end{pmatrix}, \quad \tilde{g}_m = \begin{pmatrix} g_{m-1} \\ \tilde{\gamma}_m \end{pmatrix}$$

with

$$\gamma_m = c_m \tilde{\gamma}_m. \quad (6.42)$$

Denoting by λ the scalar $\sqrt{\tilde{\xi}_m^2 + h_{m+1,m}^2}$, and using the definitions of s_m and c_m , we obtain

$$\xi_m = c_m \tilde{\xi}_m + s_m h_{m+1,m} = \frac{\tilde{\xi}_m^2}{\lambda} + \frac{h_{m+1,m}^2}{\lambda} = \lambda = \frac{\tilde{\xi}_m}{c_m}. \quad (6.43)$$

Now,

$$y_m = R_m^{-1} g_m = \begin{pmatrix} R_{m-1}^{-1} & -\frac{1}{\xi_m} R_{m-1}^{-1} z_m \\ 0 & \frac{1}{\xi_m} \end{pmatrix} \begin{pmatrix} g_{m-1} \\ \gamma_m \end{pmatrix} \quad (6.44)$$

which, upon observing that $R_{m-1}^{-1} g_{m-1} = y_{m-1}$, yields,

$$y_m - \begin{pmatrix} y_{m-1} \\ 0 \end{pmatrix} = \frac{\gamma_m}{\xi_m} \begin{pmatrix} -R_{m-1}^{-1} z_m \\ 1 \end{pmatrix}. \quad (6.45)$$

Replacing y_m, ξ_m, γ_m by $\tilde{y}_m, \tilde{\xi}_m, \tilde{\gamma}_m$, respectively, in (6.44), a relation similar to (6.45) would result except that γ_m/ξ_m is replaced by $\tilde{\gamma}_m/\tilde{\xi}_m$ which, by (6.42) and (6.43), satisfies the relation

$$\frac{\gamma_m}{\xi_m} = c_m^2 \frac{\tilde{\gamma}_m}{\tilde{\xi}_m}.$$

The result follows immediately. ■

If the FOM and GMRES iterates are denoted by the superscripts F and G , respectively, then the relation (6.41) implies that

$$x_m^G - x_{m-1}^G = c_m^2 (x_m^F - x_{m-1}^G),$$

or,

$$x_m^G = s_m^2 x_{m-1}^G + c_m^2 x_m^F. \quad (6.46)$$

This leads to the following relation for the residual vectors obtained by the two methods,

$$r_m^G = s_m^2 r_{m-1}^G + c_m^2 r_m^F \quad (6.47)$$

which indicates that, in general, the two residual vectors will evolve hand in hand. In particular, if $c_m = 0$, then GMRES will not progress at step m , a phenomenon known as stagnation. However, in this situation, according to the definitions (6.31) of the rotations, $h_{mm}^{(m-1)} = 0$ which implies that H_m is singular and, therefore, x_m^F is not defined. In fact, the reverse of this is also true, a result due to Brown [43], which is stated without proof in the following proposition.

PROPOSITION 6.11 *If at any given step m , the GMRES iterates make no progress, i.e., if $x_m^G = x_{m-1}^G$ then H_m is singular and x_m^F is not defined. Conversely, if H_m is singular at step m , i.e., if FOM breaks down at step m , and A is nonsingular, then $x_m^G = x_{m-1}^G$.*

Note also that the use of the above lemma is not restricted to the GMRES-FOM pair. Some of the iterative methods defined in this chapter and the next involve a least-squares problem of the form (6.24). In such cases, the iterates of the least-squares method and those of the orthogonal residual (Galerkin) method will be related by the same equation.

Another important observation from (6.40) is that if ρ_i is the residual norm $\|b - Ax_i\|_2$ obtained at step i , then

$$\rho_m^G = |s_m| \rho_{m-1}^G.$$

The superscripts G and F are used again to distinguish between GMRES and FOM quantities. A consequence of this is that,

$$\rho_m^G = |s_1 s_2 \dots s_m| \beta. \quad (6.48)$$

Now consider the FOM iterates, assuming that x_m is defined, i.e., that H_m is nonsingular. An equation similar to (6.48) for FOM can be derived. Using the same notation as in the proof of the lemma, and recalling that

$$\rho_m^F = h_{m+1,m} |e_m^T H_m^{-1} (\beta e_1)|,$$

note that

$$e_m^T H_m^{-1} (\beta e_1) = \frac{\tilde{\gamma}_m}{\tilde{\xi}_m}.$$

Clearly,

$$|\tilde{\gamma}_m| = |s_{m-1} \gamma_{m-1}| = \dots = |s_1 s_2 \dots s_{m-1} \beta|$$

and therefore,

$$\rho_m^F = \frac{h_{m+1,m}}{|\tilde{\xi}_m|} |s_1 s_2 \dots s_{m-1} \beta|.$$

Using (6.31), observe that $h_{m+1,m}/|\tilde{\xi}_m|$ is the tangent of the angle defining the m -th rotation, and therefore,

$$\rho_m^F = \frac{|s_m| \sqrt{\tilde{\xi}_m^2 + h_{m+1,m}^2}}{|\tilde{\xi}_m|} |s_1 s_2 \dots s_{m-1} \beta|$$

which, by a comparison with (6.48), yields a revealing relation between the residuals of

the FOM and GMRES algorithms, namely,

$$\rho_m^F = \frac{1}{c_m} \rho_m^G = \rho_m^G \sqrt{1 + \frac{h_{m+1,m}^2}{\xi_m^2}}.$$

Another way to prove the above expression is to exploit the relation (6.47); see Exercise 12. These results are summarized in the following proposition (Brown [43]).

PROPOSITION 6.12 *Assume that m steps of the Arnoldi process have been taken and that H_m is nonsingular. Let $\xi \equiv (Q_{m-1} \bar{H}_m)_{mm}$ and $h \equiv h_{m+1,m}$. Then the residual norms produced by the FOM and the GMRES algorithms are related by the equality*

$$\rho_m^F = \frac{1}{c_m} \rho_m^G = \rho_m^G \sqrt{1 + \frac{h^2}{\xi^2}}. \quad (6.49)$$

6.5.6 VARIATION 1: RESTARTING

Similar to the FOM algorithm of the previous section, the GMRES algorithm becomes impractical when m is large because of the growth of memory and computational requirements as m increases. These requirements are identical with those of FOM. As with FOM, there are two remedies. One is based on restarting and the other on truncating the Arnoldi orthogonalization. The straightforward restarting option is described here.

ALGORITHM 6.11: Restarted GMRES

1. Compute $r_0 = b - Ax_0$, $\beta = \|r_0\|_2$, and $v_1 = r_0/\beta$
 2. Generate the Arnoldi basis and the matrix \bar{H}_m using the Arnoldi algorithm
 3. starting with v_1
 4. Compute y_m which minimizes $\|\beta e_1 - \bar{H}_m y\|_2$ and $x_m = x_0 + V_m y_m$
 5. If satisfied then Stop, else set $x_0 := x_m$ and GoTo 1
-

Note that the implementation tricks discussed in the previous section can be applied, providing the residual norm at each sub-step j without computing the approximation x_j . This enables the program to exit as soon as this norm is small enough.

A well known difficulty with the restarted GMRES algorithm is that it can *stagnate* when the matrix is not positive definite. The full GMRES algorithm is guaranteed to converge in at most n steps, but this would be impractical if there were many steps required for convergence. Obviously, a preconditioner for the linear system can be used to reduce the number of steps, or a better preconditioner if one is already in use. This issue will be covered later along with preconditioning techniques.

Example 6.2 Table 6.2 shows the results of applying the GMRES algorithm with no preconditioning to three of the test problems described in Section 3.7.

The above algorithm does not minimize the norm of the residual vector over $x_0 + \mathcal{K}_m$. Rather, it attempts to perform an approximate minimization. The formula (6.35) is still valid since orthogonality is not used to derive it. Therefore,

$$b - Ax_m = V_{m+1} Q_m^T (\gamma_{m+1} e_{m+1}). \quad (6.52)$$

If the v_i 's were orthogonal to each other, then this is equivalent to GMRES and the residual norm is minimized over all vectors of the form $x_0 + V_m y$. Since only an incomplete orthogonalization is used then the v_i 's are only locally orthogonal and, as a result, only an approximate minimization may be obtained. In addition, (6.36) is no longer valid. This equality had been derived from the above equation by exploiting the orthogonality of the v_i 's. It turns out that in practice, $|\gamma_{m+1}|$ remains a reasonably good estimate of the actual residual norm because the v_i 's are nearly orthogonal. The following inequality provides an actual upper bound of the residual norm in terms of computable quantities:

$$\|b - Ax_m\| \leq \sqrt{m - k + 1} |\gamma_{m+1}|. \quad (6.53)$$

Here, k is to be replaced by m when $m \leq k$. The proof of this inequality is a consequence of (6.52). If the unit vector $q \equiv Q_m^T e_{m+1}$ has components $\eta_1, \eta_2, \dots, \eta_{m+1}$, then

$$\begin{aligned} \|b - Ax_m\|_2 &= |\gamma_{m+1}| \|V_{m+1} q\|_2 \\ &\leq |\gamma_{m+1}| \left(\left\| \sum_{i=1}^{k+1} \eta_i v_i \right\|_2 + \left\| \sum_{i=k+2}^{m+1} \eta_i v_i \right\|_2 \right) \\ &\leq |\gamma_{m+1}| \left(\left[\sum_{i=1}^{k+1} \eta_i^2 \right]^{1/2} + \sum_{i=k+2}^{m+1} |\eta_i| \|v_i\|_2 \right) \\ &\leq |\gamma_{m+1}| \left(\left[\sum_{i=1}^{k+1} \eta_i^2 \right]^{1/2} + \sqrt{m - k} \left[\sum_{i=k+2}^{m+1} \eta_i^2 \right]^{1/2} \right) \end{aligned}$$

Here, the orthogonality of the first $k + 1$ vectors v_i was used and the last term comes from using the Cauchy-Schwartz inequality. The desired inequality follows from using the Cauchy-Schwartz inequality again in the form

$$1 \cdot a + \sqrt{m - k} \cdot b \leq \sqrt{m - k + 1} \sqrt{a^2 + b^2}$$

and from the fact that the vector q is of norm unity. Thus, using $|\gamma_{m+1}|$ as a residual estimate, we would make an error of a factor of $\sqrt{m - k + 1}$ at most. In general, this is an overestimate and $|\gamma_{m+1}|$ tends to give an adequate estimate for the residual norm.

It is also interesting to observe that with a little bit more arithmetic, it is possible to actually compute the exact residual vector and norm. This is based on the observation that, according to (6.52), the residual vector is γ_{m+1} times the vector z_{m+1} which is the last column of the matrix

$$Z_{m+1} \equiv V_{m+1} Q_m^T. \quad (6.54)$$

It is an easy exercise to see that this last column can be updated from v_{m+1} and z_m . Indeed,

$$Z_{m+1} = [V_m, v_{m+1}] Q_{m-1}^T \Omega_m$$

$$\begin{aligned}
&= [V_m Q_{m-1}^T, v_{m+1}] \Omega_m \\
&= [Z_m, v_{m+1}] \Omega_m
\end{aligned}$$

where all the matrices related to the rotation are of size $(m+1) \times (m+1)$. The result is that

$$z_{m+1} = -s_m z_m + c_m v_{m+1}. \quad (6.55)$$

The z_i 's can be updated at the cost of one extra vector in memory and $4n$ operations at each step. The norm of z_{m+1} can be computed at the cost of $2n$ operations and the exact residual norm for the current approximate solution can then be obtained by multiplying this norm by $|\gamma_{m+1}|$.

Because this is a little expensive, it may be preferred to just "correct" the estimate provided by γ_{m+1} by exploiting the above recurrence relation,

$$\|z_{m+1}\|_2 \leq |s_m| \|z_m\|_2 + |c_m|.$$

If $\zeta_m \equiv \|z_m\|_2$, then the following recurrence relation holds,

$$\zeta_{m+1} \leq |s_m| \zeta_m + |c_m|. \quad (6.56)$$

The above relation is inexpensive to update, yet provides an upper bound that is sharper than (6.53); see Exercise 20.

An interesting consequence of (6.55) is a relation between two successive residual vectors:

$$\begin{aligned}
r_m &= \gamma_{m+1} z_{m+1} \\
&= \gamma_{m+1} [-s_m z_m + c_m v_{m+1}] \\
&= s_m^2 r_{m-1} + c_m \gamma_{m+1} v_{m+1}.
\end{aligned} \quad (6.57)$$

This exploits the fact that $\gamma_{m+1} = -s_m \gamma_m$ and $r_j = \gamma_{j+1} z_{j+1}$.

Example 6.3 Table 6.3 shows the results of applying the DQGMRES algorithm with no preconditioning to three of the test problems described in Section 3.7.

Matrix	Iters	Kflops	Residual	Error
F2DA	98	7216	0.36E-02	0.13E-03
F3D	75	22798	0.64E-03	0.32E-03
ORS	300	24138	0.13E+02	0.25E-02

Table 6.3 A test run of DQGMRES with no preconditioning.

See Example 6.1 for the meaning of the column headers in the table. In this test the number k of directions in the recurrence is $k = 10$.

It is possible to relate the quasi-minimal residual norm to the actual minimal residual norm provided by GMRES. The following result was proved by Nachtigal (1991) [152] for the QMR algorithm to be seen in the next chapter.

THEOREM 6.1 Assume that V_{m+1} , the Arnoldi basis associated with DQGMRES, is of full rank. Let r_m^Q and r_m^G be the residual norms obtained after m steps of the DQGMRES and GMRES algorithms, respectively. Then

$$\|r_m^Q\|_2 \leq \kappa_2(V_{m+1}) \|r_m^G\|_2. \quad (6.58)$$

Proof. Consider the subset of \mathcal{K}_{m+1} defined by

$$\mathcal{R} = \{r : r = V_{m+1}t; t = \beta e_1 - \bar{H}_m y; y \in \mathbb{C}^m\}.$$

Denote by y_m the minimizer of $\|\beta e_1 - \bar{H}_m y\|_2$ over y and $t_m = \beta e_1 - \bar{H}_m y_m$, $r_m = V_{m+1}t_m \equiv r_m^Q$. By assumption, V_{m+1} is of full rank and there is an $(m+1) \times (m+1)$ nonsingular matrix S such that $W_{m+1} = V_{m+1}S$ is unitary. Then, for any member of \mathcal{R} ,

$$r = W_{m+1}S^{-1}t, \quad t = SW_{m+1}^H r$$

and, in particular,

$$\|r_m\|_2 \leq \|S^{-1}\|_2 \|t_m\|_2. \quad (6.59)$$

Now $\|t_m\|_2$ is the minimum of the 2-norm of $\beta e_1 - \bar{H}_m y$ over all y 's and therefore,

$$\begin{aligned} \|t_m\|_2 &= \|SW_{m+1}^H r_m\| \leq \|SW_{m+1}^H r\|_2 \quad \forall r \in \mathcal{R} \\ &\leq \|S\|_2 \|r\|_2 \quad \forall r \in \mathcal{R} \\ &\leq \|S\|_2 \|r^G\|_2. \end{aligned} \quad (6.60)$$

The result follows from (6.59), (6.60), and the fact that $\kappa_2(V_{m+1}) = \kappa_2(S)$. ■

THE SYMMETRIC LANCZOS ALGORITHM

6.6

The symmetric Lanczos algorithm can be viewed as a simplification of Arnoldi's method for the particular case when the matrix is symmetric. When A is symmetric, then the Hessenberg matrix H_m becomes symmetric tridiagonal. This leads to a three-term recurrence in the Arnoldi process and short-term recurrences for solution algorithms such as FOM and GMRES. On the theoretical side, there is also much more to be said on the resulting approximation in the symmetric case.

6.6.1 THE ALGORITHM

To introduce the Lanczos algorithm we begin by making the observation stated in the following theorem.

THEOREM 6.2 Assume that Arnoldi's method is applied to a real symmetric matrix A . Then the coefficients h_{ij} generated by the algorithm are such that

$$h_{ij} = 0, \quad \text{for } 1 \leq i < j - 1, \quad (6.61)$$

$$h_{j,j+1} = h_{j+1,j}, \quad j = 1, 2, \dots, m. \quad (6.62)$$

In other words, the matrix H_m obtained from the Arnoldi process is tridiagonal and symmetric.

Proof. The proof is an immediate consequence of the fact that $H_m = V_m^T A V_m$ is a symmetric matrix which is also a Hessenberg matrix by construction. Therefore, H_m must be a symmetric tridiagonal matrix. ■

The standard notation used to describe the Lanczos algorithm is obtained by setting

$$\alpha_j \equiv h_{jj}, \quad \beta_j \equiv h_{j-1,j},$$

and if T_m denotes the resulting H_m matrix, it is of the form,

$$T_m = \begin{pmatrix} \alpha_1 & \beta_2 & & & & \\ \beta_2 & \alpha_2 & \beta_3 & & & \\ & \cdot & \cdot & \cdot & & \\ & & \beta_{m-1} & \alpha_{m-1} & \beta_m & \\ & & & \beta_m & \alpha_m & \end{pmatrix}. \quad (6.63)$$

This leads to the following form of the Modified Gram-Schmidt variant of Arnoldi's method, namely, Algorithm 6.2.

ALGORITHM 6.14: The Lanczos Algorithm

1. Choose an initial vector v_1 of norm unity. Set $\beta_1 \equiv 0, v_0 \equiv 0$
 2. For $j = 1, 2, \dots, m$ Do:
 3. $w_j := Av_j - \beta_j v_{j-1}$
 4. $\alpha_j := (w_j, v_j)$
 5. $w_j := w_j - \alpha_j v_j$
 6. $\beta_{j+1} := \|w_j\|_2$. If $\beta_{j+1} = 0$ then Stop
 7. $v_{j+1} := w_j / \beta_{j+1}$
 8. EndDo
-

It is rather surprising that the above simple algorithm guarantees, at least in exact arithmetic, that the vectors $v_i, i = 1, 2, \dots$, are orthogonal. In reality, exact orthogonality of these vectors is only observed at the beginning of the process. At some point the v_i 's start losing their global orthogonality rapidly. There has been much research devoted to finding ways to either recover the orthogonality, or to at least diminish its effects by *partial* or *selective* orthogonalization; see Parlett [160].

The major practical differences with Arnoldi's method are that the matrix H_m is tridiagonal and, more importantly, that only three vectors must be saved, unless some form of reorthogonalization is employed.

6.6.2 RELATION WITH ORTHOGONAL POLYNOMIALS

In exact arithmetic, the core of Algorithm 6.14 is a relation of the form

$$\beta_{j+1}v_{j+1} = Av_j - \alpha_jv_j - \beta_{j-1}v_{j-1}.$$

This three-term recurrence relation is reminiscent of the standard three-term recurrence relation of orthogonal polynomials. In fact, there is indeed a strong relationship between the Lanczos algorithm and orthogonal polynomials. To begin, recall that if the grade of v_1 is $\geq m$, then the subspace \mathcal{K}_m is of dimension m and consists of all vectors of the form $q(A)v_1$, where q is a polynomial with $\text{degree}(q) \leq m - 1$. In this case there is even an isomorphism between \mathcal{K}_m and \mathbb{P}_{m-1} , the space of polynomials of degree $\leq m - 1$, which is defined by

$$q \in \mathbb{P}_{m-1} \rightarrow x = q(A)v_1 \in \mathcal{K}_m.$$

Moreover, we can consider that the subspace \mathbb{P}_{m-1} is provided with the inner product

$$\langle p, q \rangle_{v_1} = (p(A)v_1, q(A)v_1). \quad (6.64)$$

This is indeed a nondegenerate bilinear form under the assumption that m does not exceed μ , the grade of v_1 . Now observe that the vectors v_i are of the form

$$v_i = q_{i-1}(A)v_1$$

and the orthogonality of the v_i 's translates into the orthogonality of the polynomials with respect to the inner product (6.64). It is known that real orthogonal polynomials satisfy a three-term recurrence. Moreover, the Lanczos procedure is nothing but the Stieltjes algorithm; (see, for example, Gautschi [102]) for computing a sequence of orthogonal polynomials with respect to the inner product (6.64). It is known [180] that the characteristic polynomial of the tridiagonal matrix produced by the Lanczos algorithm minimizes the norm $\|\cdot\|_{v_1}$ over the monic polynomials. The recurrence relation between the characteristic polynomials of tridiagonal matrices also shows that the Lanczos recurrence computes the sequence of vectors $p_{T_m}(A)v_1$, where p_{T_m} is the characteristic polynomial of T_m .

THE CONJUGATE GRADIENT ALGORITHM

6.7

The Conjugate Gradient algorithm is one of the best known iterative techniques for solving sparse Symmetric Positive Definite linear systems. Described in one sentence, the method is a realization of an orthogonal projection technique onto the Krylov subspace $\mathcal{K}_m(r_0, A)$ where r_0 is the initial residual. It is therefore mathematically equivalent to FOM. However, because A is symmetric, some simplifications resulting from the three-term Lanczos recurrence will lead to more elegant algorithms.

6.7.1 DERIVATION AND THEORY

We first derive the analogue of FOM, or Arnoldi's method, for the case when A is symmetric. Given an initial guess x_0 to the linear system $Ax = b$ and the Lanczos vectors $v_i, i = 1, \dots, m$ together with the tridiagonal matrix T_m , the approximate solution obtained from an orthogonal projection method onto \mathcal{K}_m , is given by

$$x_m = x_0 + V_m y_m, \quad y_m = T_m^{-1}(\beta e_1). \quad (6.65)$$

ALGORITHM 6.15: Lanczos Method for Linear Systems

1. Compute $r_0 = b - Ax_0$, $\beta := \|r_0\|_2$, and $v_1 := r_0/\beta$
 2. For $j = 1, 2, \dots, m$ Do:
 3. $w_j = Av_j - \beta_j v_{j-1}$ (If $j = 1$ set $\beta_1 v_0 \equiv 0$)
 4. $\alpha_j = (w_j, v_j)$
 5. $w_j := w_j - \alpha_j v_j$
 6. $\beta_{j+1} = \|w_j\|_2$. If $\beta_{j+1} = 0$ set $m := j$ and go to 9
 7. $v_{j+1} = w_j/\beta_{j+1}$
 8. EndDo
 9. Set $T_m = \text{tridiag}(\beta_i, \alpha_i, \beta_{i+1})$, and $V_m = [v_1, \dots, v_m]$.
 10. Compute $y_m = T_m^{-1}(\beta e_1)$ and $x_m = x_0 + V_m y_m$
-

Many of the results obtained from Arnoldi's method for linear systems are still valid. For example, the residual vector of the approximate solution x_m is such that

$$b - Ax_m = -\beta_{m+1} e_m^T y_m v_{m+1}. \quad (6.66)$$

The Conjugate Gradient algorithm can be derived from the Lanczos algorithm in the same way DIOM was derived from IOM. In fact, the Conjugate Gradient algorithm can be viewed as a variation of DIOM(2) for the case when A is symmetric. We will follow the same steps as with DIOM, except that the notation will be simplified whenever possible.

First write the LU factorization of T_m as $T_m = L_m U_m$. The matrix L_m is unit lower bidiagonal and U_m is upper bidiagonal. Thus, the factorization of T_m is of the form

$$T_m = \begin{pmatrix} 1 & & & & \\ \lambda_2 & 1 & & & \\ & \lambda_3 & 1 & & \\ & & \lambda_4 & 1 & \\ & & & \lambda_5 & 1 \end{pmatrix} \times \begin{pmatrix} \eta_1 & \beta_2 & & & \\ & \eta_2 & \beta_3 & & \\ & & \eta_3 & \beta_4 & \\ & & & \eta_4 & \beta_5 \\ & & & & \eta_5 \end{pmatrix}.$$

The approximate solution is then given by,

$$x_m = x_0 + V_m U_m^{-1} L_m^{-1}(\beta e_1).$$

Letting

$$P_m \equiv V_m U_m^{-1}$$

and

$$z_m = L_m^{-1} \beta e_1,$$

then,

$$x_m = x_0 + P_m z_m.$$

As for DIOM, p_m , the last column of P_m , can be computed from the previous p_i 's and v_m by the simple update

$$p_m = \eta_m^{-1}[v_m - \beta_m p_{m-1}].$$

Note that β_m is a scalar computed from the Lanczos algorithm, while η_m results from the m -th Gaussian elimination step on the tridiagonal matrix, i.e.,

$$\lambda_m = \frac{\beta_m}{\eta_{m-1}}, \quad (6.67)$$

$$\eta_m = \alpha_m - \lambda_m \beta_m. \quad (6.68)$$

In addition, following again what has been shown for DIOM,

$$z_m = \begin{bmatrix} z_{m-1} \\ \zeta_m \end{bmatrix},$$

in which $\zeta_m = -\lambda_m \zeta_{m-1}$. As a result, x_m can be updated at each step as

$$x_m = x_{m-1} + \zeta_m p_m$$

where p_m is defined above.

This gives the following algorithm, which we call the direct version of the Lanczos algorithm for linear systems.

ALGORITHM 6.16: D-Lanczos

1. Compute $r_0 = b - Ax_0$, $\zeta_1 := \beta := \|r_0\|_2$, and $v_1 := r_0/\beta$
 2. Set $\lambda_1 = \beta_1 = 0$, $p_0 = 0$
 3. For $m = 1, 2, \dots$, until convergence Do:
 4. Compute $w := Av_m - \beta_m v_{m-1}$ and $\alpha_m = (w, v_m)$
 5. If $m > 1$ then compute $\lambda_m = \frac{\beta_m}{\eta_{m-1}}$ and $\zeta_m = -\lambda_m \zeta_{m-1}$
 6. $\eta_m = \alpha_m - \lambda_m \beta_m$
 7. $p_m = \eta_m^{-1}(v_m - \beta_m p_{m-1})$
 8. $x_m = x_{m-1} + \zeta_m p_m$
 9. If x_m has converged then Stop
 10. $w := w - \alpha_m v_m$
 11. $\beta_{m+1} = \|w\|_2$, $v_{m+1} = w/\beta_{m+1}$
 12. EndDo
-

This algorithm computes the solution of the tridiagonal system $T_m y_m = \beta e_1$ progressively by using Gaussian elimination without pivoting. However, as was explained for DIOM, partial pivoting can also be implemented at the cost of having to keep an extra vector. In fact, Gaussian elimination with partial pivoting is sufficient to ensure stability for tridiagonal systems. The more complex LQ factorization has also been exploited in this context and gave rise to an algorithm known as SYMMLQ [159].

The two algorithms 6.15 and 6.16 are mathematically equivalent, that is, they deliver the same approximate solution if they are both executable. However, since Gaussian elimi-

nation without pivoting is being used implicitly to solve the tridiagonal system $T_m y = \beta e_1$, the direct version may be more prone to breakdowns.

Observe that the residual vector for this algorithm is in the direction of v_{m+1} due to equation (6.66). Therefore, the residual vectors are orthogonal to each other as in FOM. Likewise, the vectors p_i are A -orthogonal, or *conjugate*. These results are established in the next proposition.

PROPOSITION 6.13 *Let $r_m = b - Ax_m$, $m = 0, 1, \dots$, be the residual vectors produced by the Lanczos and the D-Lanczos algorithms (6.15 and 6.16) and p_m , $m = 0, 1, \dots$, the auxiliary vectors produced by Algorithm 6.16. Then,*

1. *Each residual vector r_m is such that $r_m = \sigma_m v_{m+1}$ where σ_m is a certain scalar. As a result, the residual vectors are orthogonal to each other.*
2. *The auxiliary vectors p_i form an A -conjugate set, i.e., $(Ap_i, p_j) = 0$, for $i \neq j$.*

Proof. The first part of the proposition is an immediate consequence of the relation (6.66). For the second part, it must be proved that $P_m^T A P_m$ is a diagonal matrix, where $P_m = V_m U_m^{-1}$. This follows from

$$\begin{aligned} P_m^T A P_m &= U_m^{-T} V_m^T A V_m U_m^{-1} \\ &= U_m^{-T} T_m U_m^{-1} \\ &= U_m^{-T} L_m. \end{aligned}$$

Now observe that $U_m^{-T} L_m$ is a lower triangular which is also symmetric since it is equal to the symmetric matrix $P_m^T A P_m$. Therefore, it must be a diagonal matrix. ■

A consequence of the above proposition is that a version of the algorithm can be derived by imposing the orthogonality and conjugacy conditions. This gives the Conjugate Gradient algorithm which we now derive. The vector x_{j+1} can be expressed as

$$x_{j+1} = x_j + \alpha_j p_j. \quad (6.69)$$

Therefore, the residual vectors must satisfy the recurrence

$$r_{j+1} = r_j - \alpha_j A p_j. \quad (6.70)$$

If the r_j 's are to be orthogonal, then it is necessary that $(r_j - \alpha_j A p_j, r_j) = 0$ and as a result

$$\alpha_j = \frac{(r_j, r_j)}{(A p_j, r_j)}. \quad (6.71)$$

Also, it is known that the next search direction p_{j+1} is a linear combination of r_{j+1} and p_j , and after rescaling the p vectors appropriately, it follows that

$$p_{j+1} = r_{j+1} + \beta_j p_j. \quad (6.72)$$

Thus, a first consequence of the above relation is that

$$(A p_j, r_j) = (A p_j, p_j - \beta_{j-1} p_{j-1}) = (A p_j, p_j)$$

because Ap_j is orthogonal to p_{j-1} . Then, (6.71) becomes $\alpha_j = (r_j, r_j)/(Ap_j, p_j)$. In addition, writing that p_{j+1} as defined by (6.72) is orthogonal to Ap_j yields

$$\beta_j = -\frac{(r_{j+1}, Ap_j)}{(p_j, Ap_j)}.$$

Note that from (6.70)

$$Ap_j = -\frac{1}{\alpha_j}(r_{j+1} - r_j) \quad (6.73)$$

and therefore,

$$\beta_j = \frac{1}{\alpha_j} \frac{(r_{j+1}, (r_{j+1} - r_j))}{(Ap_j, p_j)} = \frac{(r_{j+1}, r_{j+1})}{(r_j, r_j)}.$$

Putting these relations together gives the following algorithm.

ALGORITHM 6.17: Conjugate Gradient

1. Compute $r_0 := b - Ax_0$, $p_0 := r_0$.
 2. For $j = 0, 1, \dots$, until convergence Do:
 3. $\alpha_j := (r_j, r_j)/(Ap_j, p_j)$
 4. $x_{j+1} := x_j + \alpha_j p_j$
 5. $r_{j+1} := r_j - \alpha_j Ap_j$
 6. $\beta_j := (r_{j+1}, r_{j+1})/(r_j, r_j)$
 7. $p_{j+1} := r_{j+1} + \beta_j p_j$
 8. EndDo
-

It is important to note that the scalars α_j, β_j in this algorithm are different from those of the Lanczos algorithm. The vectors p_j are multiples of the p_j 's of Algorithm 6.16.

In terms of storage, in addition to the matrix A , four vectors (x , p , Ap , and r) must be saved in Algorithm 6.17, versus five vectors (v_m , v_{m-1} , w , p , and x) for Algorithm 6.16.

6.7.2 ALTERNATIVE FORMULATIONS

Algorithm 6.17 is the best known formulation of the Conjugate Gradient algorithm. There are, however, several alternative formulations. Here, only one such formulation is shown, which can be derived once more from the Lanczos algorithm.

The residual polynomial $r_m(t)$ associated with the m -th CG iterate must satisfy a three-term recurrence, implied by the three-term recurrence of the Lanczos vectors. Indeed, these vectors are just the scaled versions of the residual vectors. Therefore, we must seek a three-term recurrence of the form

$$r_{m+1}(t) = \rho_m(r_m(t) - \gamma_m t r_m(t)) + \delta_m r_{m-1}(t).$$

In addition, the consistency condition $r_m(0) = 1$ must be maintained for each m , leading to the recurrence,

$$r_{m+1}(t) = \rho_m(r_m(t) - \gamma_m t r_m(t)) + (1 - \rho_m)r_{m-1}(t). \quad (6.74)$$

Observe that if $r_m(0) = 1$ and $r_{m-1}(0) = 1$, then $r_{m+1}(0) = 1$, as desired. Translating the above relation into the sequence of residual vectors yields

$$r_{m+1} = \rho_m(r_m - \gamma_m Ar_m) + (1 - \rho_m)r_{m-1}. \quad (6.75)$$

Recall that the vectors r_i 's are multiples of the Lanczos vectors v_i 's. As a result, γ_m should be the inverse of the scalar α_m of the Lanczos algorithm. In terms of the r -vectors this means

$$\gamma_m = \frac{(r_m, r_m)}{(Ar_m, r_m)}.$$

Equating the inner products of both sides of (6.75) with r_{m-1} , and using the orthogonality of the r -vectors, gives the following expression for ρ_m , after some algebraic calculations,

$$\rho_m = \left[1 - \frac{\gamma_m}{\gamma_{m-1}} \frac{(r_m, r_m)}{(r_{m-1}, r_{m-1})} \frac{1}{\rho_{m-1}} \right]^{-1}. \quad (6.76)$$

The recurrence relation for the approximate solution vectors can be extracted from the recurrence relation for the residual vectors. This is found by starting from (6.74) and using the relation $r_m(t) = 1 - ts_{m-1}(t)$ between the solution polynomial $s_{m-1}(t)$ and the residual polynomial $r_m(t)$. Thus,

$$\begin{aligned} s_m(t) &= \frac{1 - r_{m+1}(t)}{t} \\ &= \rho_m \left(\frac{1 - r_m(t)}{t} - \gamma_m r_m(t) \right) + (1 - \rho_m) \frac{1 - r_{m-1}(t)}{t} \\ &= \rho_m (s_{m-1}(t) - \gamma_m r_m(t)) + (1 - \rho_m) s_{m-2}(t). \end{aligned}$$

This gives the recurrence,

$$x_{m+1} = \rho_m(x_m - \gamma_m r_m) + (1 - \rho_m)x_{m-1}. \quad (6.77)$$

All that is left for the recurrence to be determined completely is to define the first two iterates. The initial iterate x_0 is given. The first vector should be of the form

$$x_1 = x_0 - \gamma_0 r_0,$$

to ensure that r_1 is orthogonal to r_0 . This means that the two-term recurrence can be started with $\rho_0 = 1$, and by setting $x_{-1} \equiv 0$. Putting these relations and definitions together gives the following algorithm.

ALGORITHM 6.18: CG – Three-Term Recurrence Variant

1. Compute $r_0 = b - Ax_0$. Set $x_{-1} \equiv 0$ and $\rho_0 = 1$.
 2. For $j = 0, 1, \dots$, until convergence Do:
 3. Compute Ar_j and $\gamma_j = \frac{(r_j, r_j)}{(Ar_j, r_j)}$
 4. If ($j > 0$) compute $\rho_j = \left[1 - \frac{\gamma_j}{\gamma_{j-1}} \frac{(r_j, r_j)}{(r_{j-1}, r_{j-1})} \frac{1}{\rho_{j-1}} \right]^{-1}$
 5. $x_{j+1} = \rho_j (x_j - \gamma_j r_j) + (1 - \rho_j)x_{j-1}$
 6. Compute $r_{j+1} = \rho_j (r_j - \gamma_j Ar_j) + (1 - \rho_j)r_{j-1}$
 7. EndDo
-

The residual r_{j+1} could also be computed directly as $r_{j+1} = b - Ax_{j+1}$ in line 6 of the algorithm, but this would require an additional matrix-vector product.

6.7.3 EIGENVALUE ESTIMATES FROM THE CG COEFFICIENTS

Sometimes, it is useful to be able to obtain the tridiagonal matrix T_m related to the underlying Lanczos iteration from the coefficients of the Conjugate Gradient algorithm 6.17. This tridiagonal matrix can provide valuable eigenvalue information on the matrix A . For example, the largest and smallest eigenvalues of the tridiagonal matrix can approximate the smallest and largest eigenvalues of A . This could be used to compute an estimate of the condition number of A which in turn can help provide estimates of the error norm from the residual norm. Since the Greek letters α_i and β_i have been used in both algorithms, notations must be changed. Denote by

$$T_m = \text{tridiag} [\eta_j, \delta_j, \eta_{j+1}],$$

the tridiagonal matrix (6.63) associated with the m -th step of the Lanczos algorithm. We must seek expressions of the coefficients η_j, δ_j in terms of the coefficients α_j, β_j , obtained from the CG algorithm. The key information regarding the correspondence between the two pairs of coefficients resides in the correspondence between the vectors generated by the two algorithms. From (6.66) it is known that

$$r_j = \text{scalar} \times v_{j+1}. \quad (6.78)$$

As a result,

$$\delta_{j+1} = \frac{(Av_{j+1}, v_{j+1})}{(v_{j+1}, v_{j+1})} = \frac{(Ar_j, r_j)}{(r_j, r_j)}.$$

The denominator (r_j, r_j) is readily available from the coefficients of the CG algorithm, but the numerator (Ar_j, r_j) is not. The relation (6.72) can be exploited to obtain

$$r_j = p_j - \beta_{j-1}p_{j-1} \quad (6.79)$$

which is then substituted in (Ar_j, r_j) to get

$$(Ar_j, r_j) = (A(p_j - \beta_{j-1}p_{j-1}), p_j - \beta_{j-1}p_{j-1}).$$

Note that the terms $\beta_{j-1}p_{j-1}$ are defined to be zero when $j = 0$. Because the p vectors are A -orthogonal,

$$(Ar_j, r_j) = (Ap_j, p_j) + \beta_{j-1}^2 (Ap_{j-1}, p_{j-1}),$$

from which we finally obtain for $j > 0$,

$$\delta_{j+1} = \frac{(Ap_j, p_j)}{(r_j, r_j)} + \beta_{j-1}^2 \frac{(Ap_{j-1}, p_{j-1})}{(r_j, r_j)} = \frac{1}{\alpha_j} + \frac{\beta_{j-1}}{\alpha_{j-1}}. \quad (6.80)$$

The above expression is only valid for $j > 0$. For $j = 0$, the second term in the right-hand side should be omitted as was observed above. Therefore, the diagonal elements of T_m are

given by

$$\delta_{j+1} = \begin{cases} \frac{1}{\alpha_j} & \text{for } j = 0, \\ \frac{1}{\alpha_j} + \frac{\beta_{j-1}}{\alpha_{j-1}} & \text{for } j > 0. \end{cases} \quad (6.81)$$

Now an expression for the co-diagonal elements η_{j+1} is needed. From the definitions in the Lanczos algorithm,

$$\eta_{j+1} = (Av_j, v_{j+1}) = \frac{|(Ar_{j-1}, r_j)|}{\|r_{j-1}\|_2 \|r_j\|_2}.$$

Using (6.79) again and the relation (6.73) as well as orthogonality properties of the CG algorithm, the following sequence of equalities results:

$$\begin{aligned} (Ar_{j-1}, r_j) &= (A(p_{j-1} - \beta_{j-2}p_{j-2}), r_j) \\ &= (Ap_{j-1}, r_j) - \beta_{j-2}(Ap_{j-2}, r_j) \\ &= \frac{-1}{\alpha_{j-1}}(r_j - r_{j-1}, r_j) + \frac{\beta_{j-2}}{\alpha_{j-2}}(r_{j-1} - r_{j-2}, r_j) \\ &= \frac{-1}{\alpha_{j-1}}(r_j, r_j). \end{aligned}$$

Therefore,

$$\eta_{j+1} = \frac{1}{\alpha_{j-1}} \frac{(r_j, r_j)}{\|r_{j-1}\|_2 \|r_j\|_2} = \frac{1}{\alpha_{j-1}} \frac{\|r_j\|_2}{\|r_{j-1}\|_2} = \frac{\sqrt{\beta_{j-1}}}{\alpha_{j-1}}.$$

This finally gives the general form of the m -dimensional Lanczos tridiagonal matrix in terms of the CG coefficients,

$$T_m = \begin{pmatrix} \frac{1}{\alpha_0} & \frac{\sqrt{\beta_0}}{\alpha_0} & & & & & \\ \frac{\sqrt{\beta_0}}{\alpha_0} & \frac{1}{\alpha_1} + \frac{\beta_0}{\alpha_0} & \frac{\sqrt{\beta_1}}{\alpha_1} & & & & \\ & \cdot & \cdot & \cdot & & & \\ & & & \cdot & & & \\ & & & & \frac{\sqrt{\beta_{m-2}}}{\alpha_{m-2}} & & \\ & & & & \frac{\sqrt{\beta_{m-2}}}{\alpha_{m-2}} & \frac{1}{\alpha_{m-1}} + \frac{\beta_{m-2}}{\alpha_{m-2}} & \\ & & & & & & \end{pmatrix}. \quad (6.82)$$

THE CONJUGATE RESIDUAL METHOD

6.8

In the previous section we derived the Conjugate Gradient algorithm as a special case of FOM for Symmetric Positive Definite matrices. Similarly, a new algorithm can be derived from GMRES for the particular case where A is Hermitian. In this case, the residual vectors should be A -orthogonal, i.e., conjugate. In addition, the vectors Ap_i 's $i = 0, 1, \dots$, are orthogonal. When looking for an algorithm with the same structure as CG, but satisfying these conditions, we find the Conjugate Residual algorithm. Notice that the residual vectors are now conjugate to each other, hence, the name of the algorithm.

ALGORITHM 6.19: Conjugate Residual Algorithm

1. Compute $r_0 := b - Ax_0$, $p_0 := r_0$
2. For $j = 0, 1, \dots$, until convergence Do:
3. $\alpha_j := (r_j, Ar_j)/(Ap_j, Ap_j)$
4. $x_{j+1} := x_j + \alpha_j p_j$
5. $r_{j+1} := r_j - \alpha_j Ap_j$
6. $\beta_j := (r_{j+1}, Ar_{j+1})/(r_j, Ar_j)$
7. $p_{j+1} := r_{j+1} + \beta_j p_j$
8. Compute $Ap_{j+1} = Ar_{j+1} + \beta_j Ap_j$
9. EndDo

The last line in the above algorithm computes Ap_{j+1} from Ar_{j+1} without an additional matrix-vector product. Five vectors of storage are needed in addition to the matrix A : x , p , Ap , r , Ar . The algorithm requires one more vector update, i.e., $2n$ more operations than the Conjugate Gradient method and one more vector of storage. Since the two methods exhibit typically a similar convergence behavior, the Conjugate Gradient method is often preferred over the Conjugate Residual algorithm.

GCR, ORTHOMIN, AND ORTHODIR

6.9

All algorithms developed in this chapter are strongly related to, as well as defined by, the choice of a basis of the Krylov subspace. The GMRES algorithm uses an orthogonal basis. In the Conjugate Gradient algorithm, the p 's are A -orthogonal, i.e., conjugate. In the Conjugate Residual method just described, the Ap_i 's are orthogonal, i.e., the p_i 's are $A^T A$ -orthogonal. A number of algorithms can be developed using a basis of this form in the nonsymmetric case as well. The main result that is exploited in all these algorithms is the following lemma.

LEMMA 6.2 Let p_0, p_1, \dots, p_{m-1} be a basis of the Krylov subspace $\mathcal{K}_m(A, r_0)$ which is $A^T A$ -orthogonal, i.e., such that

$$(Ap_i, Ap_j) = 0, \quad \text{for } i \neq j.$$

Then the approximate solution x_m which has the smallest residual norm in the affine space $x_0 + \mathcal{K}_m(A, r_0)$ is given by

$$x_m = x_0 + \sum_{i=0}^{m-1} \frac{(r_0, Ap_i)}{(Ap_i, Ap_i)} p_i. \quad (6.83)$$

In addition, x_m can be computed from x_{m-1} by

$$x_m = x_{m-1} + \frac{(r_{m-1}, Ap_{m-1})}{(Ap_{m-1}, Ap_{m-1})} p_{m-1}. \quad (6.84)$$

Proof. The approximate solution and the associated residual vector can be written in the form

$$x_m = x_0 + \sum_{i=0}^{m-1} \alpha_i p_i, \quad r_m = r_0 - \sum_{i=0}^{m-1} \alpha_i A p_i. \quad (6.85)$$

According to the optimality result of Proposition 5.3, in order for $\|r_m\|_2$ to be minimum, the orthogonality relations

$$(r_m, A p_i) = 0, \quad i = 0, \dots, m-1$$

must be enforced. Using (6.85) and the orthogonality of the $A p_i$'s gives immediately,

$$\alpha_i = (r_0, A p_i) / (A p_i, A p_i).$$

This proves the first part of the lemma. Assume now that x_{m-1} is known and that x_m must be determined. According to formula (6.83), $x_m = x_{m-1} + \alpha_{m-1} p_{m-1}$ with α_{m-1} defined above. Note that from the second part of (6.85),

$$r_{m-1} = r_0 - \sum_{j=0}^{m-2} \alpha_j A p_j$$

so that

$$(r_{m-1}, A p_{m-1}) = (r_0, A p_{m-1}) - \sum_{j=0}^{m-2} \alpha_j (A p_j, A p_{m-1}) = (r_0, A p_{m-1})$$

exploiting, once more, the orthogonality of the vectors $A p_j$, $j = 0, \dots, m-1$. Thus,

$$\alpha_{m-1} = \frac{(r_{m-1}, A p_{m-1})}{(A p_{m-1}, A p_{m-1})},$$

which proves the expression (6.84). ■

This lemma opens up many different ways to obtain algorithms that are mathematically equivalent to the full GMRES. The simplest option computes the next basis vector p_{m+1} as a linear combination of the current residual r_m and all previous p_i 's. The approximate solution is updated by using (6.84). This is called the Generalized Conjugate Residual (GCR) algorithm.

ALGORITHM 6.20: GCR

1. Compute $r_0 = b - A x_0$. Set $p_0 = r_0$.
 2. For $j = 0, 1, 2, \dots$, until convergence Do:
 3. $\alpha_j = \frac{(r_j, A p_j)}{(A p_j, A p_j)}$
 4. $x_{j+1} = x_j + \alpha_j p_j$
 5. $r_{j+1} = r_j - \alpha_j A p_j$
 6. Compute $\beta_{ij} = -\frac{(A r_{j+1}, A p_i)}{(A p_i, A p_i)}$, for $i = 0, 1, \dots, j$
 7. $p_{j+1} = r_{j+1} + \sum_{i=0}^j \beta_{ij} p_i$
 8. EndDo
-

To compute the scalars β_{ij} in the above algorithm, the vector Ar_j and the previous Ap_i 's are required. In order to limit the number of matrix-vector products per step to one, we can proceed as follows. Follow line 5 by a computation of Ar_{j+1} and then compute Ap_{j+1} after line 7 from the relation

$$Ap_{j+1} = Ar_{j+1} + \sum_{i=0}^j \beta_{ij} Ap_i.$$

Both the set of p_i 's and that of the Ap_i 's need to be saved. This doubles the storage requirement compared with GMRES. The number of arithmetic operations per step is also roughly 50% higher than GMRES.

The above version of GCR suffers from the same practical limitations as GMRES and FOM. A restarted version called GCR(m) can be trivially defined. Also, a truncation of the orthogonalization of the Ap_i 's, similar to IOM, leads to an algorithm known as ORTHOMIN(k). Specifically, lines 6 and 7 of Algorithm 6.20 are replaced by

$$\begin{aligned} 6a. \quad & \text{Compute } \beta_{ij} = -\frac{(Ar_{j+1}, Ap_i)}{(Ap_i, Ap_i)}, \text{ for } i = j - k + 1, \dots, j \\ 7a. \quad & p_{j+1} = r_{j+1} + \sum_{i=j-k+1}^j \beta_{ij} p_i. \end{aligned}$$

Another class of algorithms is defined by computing the next basis vector p_{j+1} as

$$p_{j+1} = Ap_j + \sum_{i=0}^j \beta_{ij} p_i \quad (6.86)$$

in which, as before, the β_{ij} 's are selected to make the Ap_i 's orthogonal, i.e.,

$$\beta_{ij} = -\frac{(A^2 p_j, Ap_i)}{(Ap_i, Ap_i)}.$$

The resulting algorithm is called ORTHODIR [127]. Restarted and truncated versions of ORTHODIR can also be defined.

THE FABER-MANTEUFFEL THEOREM

6.10

As was seen in Section 6.6 when A is symmetric, the Arnoldi algorithm simplifies into the Lanczos procedure, which is defined through a three-term recurrence. As a consequence, FOM is mathematically equivalent to the Conjugate Gradient algorithm in this case. Similarly, the full GMRES algorithm gives rise to the Conjugate Residual algorithm. It is clear that the CG-type algorithms, i.e., algorithms defined through short-term recurrences, are more desirable than those algorithms which require storing entire sequences of vectors as in the GMRES process. These algorithms require less memory and operations per step.

Therefore, the question is: *Is it possible to define algorithms which are based on optimal Krylov subspace projection and which give rise to sequences involving short-term recurrences?* An optimal Krylov subspace projection means a technique which minimizes a certain norm of the error, or residual, on the Krylov subspace. Such methods can be de-

defined from the Arnoldi process. If the Arnoldi process simplifies into an s -term recurrence, i.e., if $h_{ij} = 0$ for $i < j - s + 1$, then the conjugate directions p_i in DIOM are also defined from an s -term recurrence. Similarly, the full GMRES would also simplify into a DQGMRES algorithm involving a short recurrence. Therefore, for all purposes, it is sufficient to analyze what happens to the Arnoldi process (or FOM). We start by generalizing the CG result in a simple way, by considering the DIOM algorithm.

PROPOSITION 6.14 *Let A be a matrix such that*

$$A^T v \in \mathcal{K}_s(A, v)$$

for any vector v . Then, DIOM(s) is mathematically equivalent to the FOM algorithm.

Proof. The assumption is equivalent to the statement that, for any v , there is a polynomial q_v of degree $\leq s - 1$, such that $A^T v = q_v(A)v$. In the Arnoldi process, the scalars h_{ij} are defined by $h_{ij} = (Av_j, v_i)$ and therefore

$$h_{ij} = (Av_j, v_i) = (v_j, A^T v_i) = (v_j, q_{v_j}(A)v_i). \quad (6.87)$$

Since q_{v_j} is a polynomial of degree $\leq s - 1$, the vector $q_{v_j}(A)v_i$ is a linear combination of the vectors $v_i, v_{i+1}, \dots, v_{i+s-1}$. As a result, if $i < j - s + 1$, then $h_{ij} = 0$. Therefore, DIOM(k) will give the same approximate solution as FOM. ■

In particular, if

$$A^T = q(A)$$

where q is a polynomial of degree $\leq s - 1$, then the result holds. However, the above relation implies that each eigenvector of A is also an eigenvector of A^T . According to Theorem 1.2, this can be true only if A is a normal matrix. As it turns out, the reverse is also true. That is, when A is normal, then there is a polynomial of degree $\leq n - 1$ such that $A^H = q(A)$. Proving this is easy because when $A = Q\Lambda Q^H$ where Q is unitary and Λ diagonal, then $q(A) = Qq(\Lambda)Q^H$. By choosing the polynomial q so that

$$q(\lambda_j) = \bar{\lambda}_j, \quad j = 1, \dots, n$$

we obtain $q(A) = Q\bar{\Lambda}Q^H = A^H$ which is the desired result.

Let $\nu(A)$ be the smallest degree of all polynomials q such that $A^H = q(A)$. Then the following lemma due to Faber and Manteuffel [85] states an interesting relation between s and $\nu(A)$.

LEMMA 6.3 *A nonsingular matrix A is such that*

$$A^H v \in \mathcal{K}_s(A, v)$$

for every vector v if and only if A is normal and $\nu(A) \leq s - 1$.

Proof. The sufficient condition is trivially true. To prove the necessary condition, assume that, for any vector v , $A^H v = q_v(A)v$ where q_v is a polynomial of degree $\leq s - 1$. Then it is easily seen that any eigenvector of A is also an eigenvector of A^H . Therefore, from Theorem 1.2, A is normal. Let μ be the degree of the minimal polynomial for A . Then, since A has μ distinct eigenvalues, there is a polynomial q of degree $\mu - 1$ such that

$q(\lambda_i) = \bar{\lambda}_i$ for $i = 1, \dots, \mu$. According to the above argument, for this q , it holds $A^H = q(A)$ and therefore $\nu(A) \leq \mu - 1$. Now it must be shown that $\mu \leq s$. Let w be a (nonzero) vector whose grade is μ . By assumption, $A^H w \in \mathcal{K}_s(A, w)$. On the other hand, we also have $A^H w = q(A)w$. Since the vectors $w, Aw, \dots, A^{\mu-1}w$ are linearly independent, $\mu - 1$ must not exceed $s - 1$. Otherwise, two different expressions for $A^H w$ with respect to the basis $w, Aw, \dots, A^{\mu-1}w$ would result and this would imply that $A^H w = 0$. Since A is nonsingular, then $w = 0$, which is a contradiction. ■

Proposition 6.14 gives a sufficient condition for DIOM(s) to be equivalent to FOM. According to Lemma 6.3, this condition is equivalent to A being normal and $\nu(A) \leq s - 1$. Now consider the reverse result. Faber and Manteuffel define CG(s) to be the class of all matrices such that for every v_1 , it is true that $(Av_j, v_i) = 0$ for all i, j such that $i + s \leq j \leq \mu(v_1) - 1$. The inner product can be different from the canonical Euclidean dot product. With this definition it is possible to show the following theorem [85] which is stated without proof.

THEOREM 6.3 $A \in CG(s)$, if and only if $\mu(A) \leq s$ or A is normal and $\nu(A) \leq s - 1$.

It is interesting to consider the particular case where $\nu(A) \leq 1$, which is the case of the Conjugate Gradient method. In fact, it is easy to show that in this case A either has a minimal degree ≤ 1 , or is Hermitian, or is of the form

$$A = e^{i\theta} (\rho I + B)$$

where θ and ρ are real and B is skew-Hermitian, i.e., $B^H = -B$. Thus, the cases in which DIOM simplifies into an (optimal) algorithm defined from a three-term recurrence are already known. The first is the Conjugate Gradient method. The second is a version of the CG algorithm for skew-Hermitian matrices which can be derived from the Lanczos algorithm in the same way as CG. This algorithm will be seen in Chapter 9.

CONVERGENCE ANALYSIS

6.11

The convergence behavior of the different algorithms seen in this chapter can be analyzed by exploiting optimality properties whenever such properties exist. This is the case for the Conjugate Gradient and the GMRES algorithms. On the other hand, the non-optimal algorithms such as FOM, IOM, and QGMRES will be harder to analyze.

One of the main tools used in the analysis of these methods is Chebyshev polynomials. These polynomials are useful both in theory, when studying convergence, and in practice, as a means of accelerating single-vector iterations or projection processes. In the following, real and complex Chebyshev polynomials are discussed separately.

6.11.1 REAL CHEBYSHEV POLYNOMIALS

The Chebyshev polynomial of the first kind of degree k is defined by

$$C_k(t) = \cos[k \cos^{-1}(t)] \quad \text{for } -1 \leq t \leq 1. \quad (6.88)$$

That this is a polynomial with respect to t can be shown easily by induction from the trigonometric relation

$$\cos[(k+1)\theta] + \cos[(k-1)\theta] = 2 \cos \theta \cos k\theta,$$

and the fact that $C_1(t) = t$, $C_0(t) = 1$. Incidentally, this also shows the important three-term recurrence relation

$$C_{k+1}(t) = 2t C_k(t) - C_{k-1}(t).$$

The definition (6.88) can be extended to cases where $|t| > 1$ with the help of the following formula:

$$C_k(t) = \cosh[k \cosh^{-1}(t)], \quad |t| \geq 1. \quad (6.89)$$

This is readily seen by passing to complex variables and using the definition $\cos \theta = (e^{i\theta} + e^{-i\theta})/2$. As a result of (6.89) the following expression can be derived:

$$C_k(t) = \frac{1}{2} \left[\left(t + \sqrt{t^2 - 1} \right)^k + \left(t + \sqrt{t^2 - 1} \right)^{-k} \right], \quad (6.90)$$

which is valid for $|t| \geq 1$ but can also be extended to the case of $|t| < 1$. The following approximation, valid for large values of k , will be sometimes used:

$$C_k(t) \approx \frac{1}{2} \left(t + \sqrt{t^2 - 1} \right)^k \quad \text{for } |t| \geq 1. \quad (6.91)$$

In what follows we denote by \mathbb{P}_k the set of all polynomials of degree k . An important result from approximation theory is the following theorem.

THEOREM 6.4 *Let $[\alpha, \beta]$ be a non-empty interval in \mathbb{R} and let γ be any real scalar outside the interval $[\alpha, \beta]$. Then the minimum*

$$\min_{p \in \mathbb{P}_k, p(\gamma)=1} \max_{t \in [\alpha, \beta]} |p(t)|$$

is reached by the polynomial

$$\hat{C}_k(t) \equiv \frac{C_k \left(1 + 2 \frac{t-\beta}{\beta-\alpha} \right)}{C_k \left(1 + 2 \frac{\gamma-\beta}{\beta-\alpha} \right)}. \quad (6.92)$$

For a proof, see Cheney [52]. The maximum of C_k for t in $[-1, 1]$ is 1 and a corollary of the above result is

$$\min_{p \in \mathbb{P}_k, p(\gamma)=1} \max_{t \in [\alpha, \beta]} |p(t)| = \frac{1}{|C_k(1 + 2 \frac{\gamma-\beta}{\beta-\alpha})|} = \frac{1}{|C_k(2 \frac{\gamma-\mu}{\beta-\alpha})|}$$

in which $\mu \equiv (\alpha + \beta)/2$ is the middle of the interval. The absolute values in the denominator are needed only when γ is to the left of the interval, i.e., when $\gamma \leq \alpha$. For this case, it may be more convenient to express the best polynomial as

$$\hat{C}_k(t) \equiv \frac{C_k\left(1 + 2\frac{\alpha-t}{\beta-\alpha}\right)}{C_k\left(1 + 2\frac{\alpha-\gamma}{\beta-\alpha}\right)}$$

which is obtained by exchanging the roles of α and β in (6.92).

6.11.2 COMPLEX CHEBYSHEV POLYNOMIALS

The standard definition of real Chebyshev polynomials given by equation (6.88) extends without difficulty to complex variables. First, as was seen before, when t is real and $|t| > 1$, the alternative definition, $C_k(t) = \cosh[k \cosh^{-1}(t)]$, can be used. These definitions can be unified by switching to complex variables and writing

$$C_k(z) = \cosh(k\zeta), \quad \text{where} \quad \cosh(\zeta) = z.$$

Defining the variable $w = e^\zeta$, the above formula is equivalent to

$$C_k(z) = \frac{1}{2}[w^k + w^{-k}] \quad \text{where} \quad z = \frac{1}{2}[w + w^{-1}]. \quad (6.93)$$

The above definition for Chebyshev polynomials will be used in \mathbb{C} . Note that the equation $\frac{1}{2}(w + w^{-1}) = z$ has two solutions w which are inverse of each other. As a result, the value of $C_k(z)$ does not depend on which of these solutions is chosen. It can be verified directly that the C_k 's defined by the above equations are indeed polynomials in the z variable and that they satisfy the three-term recurrence

$$\begin{aligned} C_{k+1}(z) &= 2zC_k(z) - C_{k-1}(z), \\ C_0(z) &\equiv 1, \quad C_1(z) \equiv z. \end{aligned} \quad (6.94)$$

As is now explained, Chebyshev polynomials are intimately related to ellipses in the complex plane. Let C_ρ be the circle of radius ρ centered at the origin. Then the so-called Joukowski mapping

$$J(w) = \frac{1}{2}[w + w^{-1}]$$

transforms C_ρ into an ellipse of center the origin, foci $-1, 1$, major semi-axis $\frac{1}{2}[\rho + \rho^{-1}]$ and minor semi-axis $\frac{1}{2}|\rho - \rho^{-1}|$. This is illustrated in Figure 6.2.

There are two circles which have the same image by the mapping $J(w)$, one with the radius ρ and the other with the radius ρ^{-1} . So it is sufficient to consider only those circles with radius $\rho \geq 1$. Note that the case $\rho = 1$ is a degenerate case in which the ellipse $E(0, 1, -1)$ reduces to the interval $[-1, 1]$ traveled through twice.

An important question is whether or not a generalization of the min-max result of Theorem 6.4 holds for the complex case. Here, the maximum of $|p(z)|$ is taken over the ellipse boundary and γ is some point not enclosed by the ellipse. The answer to the question is no; Chebyshev polynomials are only optimal in some cases. However, Chebyshev polynomials are asymptotically optimal, which is all that is needed in practice.

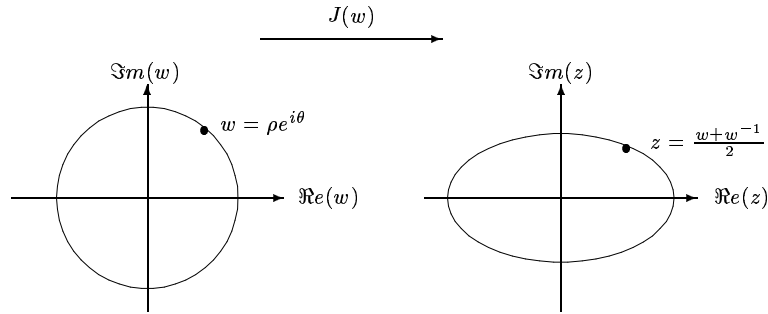

Figure 6.2 The Joukowski mapping transforms a circle into an ellipse in the complex plane.

To prove the asymptotic optimality, we begin with a lemma due to Zarantonello, which deals with the particular case where the ellipse reduces to a circle. This particular case is important in itself.

LEMMA 6.4 Zarantonello Let $C(0, \rho)$ be a circle of center the origin and radius ρ and let γ be a point of \mathbb{C} not enclosed by $C(0, \rho)$. Then

$$\min_{p \in \mathbb{P}_k, p(\gamma)=1} \max_{z \in C(0, \rho)} |p(z)| = \left(\frac{\rho}{|\gamma|} \right)^k, \quad (6.95)$$

the minimum being achieved for the polynomial $(z/\gamma)^k$.

Proof. See reference [168] for a proof. ■

Note that by changing variables, shifting, and rescaling the polynomial, then for any circle centered at c and for any scalar γ such that $|\gamma| > \rho$, the following min-max result holds:

$$\min_{p \in \mathbb{P}_k, p(\gamma)=1} \max_{z \in C(c, \rho)} |p(z)| = \left(\frac{\rho}{|\gamma - c|} \right)^k.$$

Now consider the case of an ellipse centered at the origin, with foci $1, -1$ and semi-major axis a , which can be considered as mapped by J from the circle $C(0, \rho)$, with the convention that $\rho \geq 1$. Denote by E_ρ such an ellipse.

THEOREM 6.5 Consider the ellipse E_ρ mapped from $C(0, \rho)$ by the mapping J and let γ be any point in the complex plane not enclosed by it. Then

$$\frac{\rho^k}{|w_\gamma|^k} \leq \min_{p \in \mathbb{P}_k, p(\gamma)=1} \max_{z \in E_\rho} |p(z)| \leq \frac{\rho^k + \rho^{-k}}{|w_\gamma^k + w_\gamma^{-k}|} \quad (6.96)$$

in which w_γ is the dominant root of the equation $J(w) = \gamma$.

Proof. We start by showing the second inequality. Any polynomial p of degree k satis-

fyng the constraint $p(\gamma) = 1$ can be written as

$$p(z) = \frac{\sum_{j=0}^k \xi_j z^j}{\sum_{j=0}^k \xi_j \gamma^j}.$$

A point z on the ellipse is transformed by J from a certain w in $C(0, \rho)$. Similarly, let w_γ be one of the two inverse transforms of γ by the mapping, namely, the one with largest modulus. Then, p can be rewritten as

$$p(z) = \frac{\sum_{j=0}^k \xi_j (w^j + w^{-j})}{\sum_{j=0}^k \xi_j (w_\gamma^j + w_\gamma^{-j})}. \quad (6.97)$$

Consider the particular polynomial obtained by setting $\xi_k = 1$ and $\xi_j = 0$ for $j \neq k$,

$$p^*(z) = \frac{w^k + w^{-k}}{w_\gamma^k + w_\gamma^{-k}}$$

which is a scaled Chebyshev polynomial of the first kind of degree k in the variable z . It is apparent that the maximum modulus of this polynomial is reached in particular when $w = \rho e^{i\theta}$ is real, i.e., when $w = \rho$. Thus,

$$\max_{z \in E_\rho} |p^*(z)| = \frac{\rho^k + \rho^{-k}}{|w_\gamma^k + w_\gamma^{-k}|}$$

which proves the second inequality.

To prove the left inequality, we rewrite (6.97) as

$$p(z) = \left(\frac{w^{-k}}{w_\gamma^{-k}} \right) \frac{\sum_{j=0}^k \xi_j (w^{k+j} + w^{k-j})}{\sum_{j=0}^k \xi_j (w_\gamma^{k+j} + w_\gamma^{k-j})}$$

and take the modulus of $p(z)$,

$$|p(z)| = \frac{\rho^{-k}}{|w_\gamma|^{-k}} \left| \frac{\sum_{j=0}^k \xi_j (w^{k+j} + w^{k-j})}{\sum_{j=0}^k \xi_j (w_\gamma^{k+j} + w_\gamma^{k-j})} \right|.$$

The polynomial in w of degree $2k$ inside the large modulus bars in the right-hand side is such that its value at w_γ is one. By Lemma 6.4, the modulus of this polynomial over the circle $C(0, \rho)$ is not less than $(\rho/|w_\gamma|)^{2k}$, i.e., for any polynomial, satisfying the constraint $p(\gamma) = 1$,

$$\max_{z \in E_\rho} |p(z)| \geq \frac{\rho^{-k}}{|w_\gamma|^{-k}} \frac{\rho^{2k}}{|w_\gamma|^{2k}} = \frac{\rho^k}{|w_\gamma|^k}.$$

This proves that the minimum over all such polynomials of the maximum modulus on the ellipse E_ρ is $\geq (\rho/|w_\gamma|)^k$. ■

The difference between the left and right bounds in (6.96) tends to zero as k increases to infinity. Thus, the important point made by the theorem is that for large k , the Chebyshev polynomial

$$p^*(z) = \frac{w^k + w^{-k}}{w_\gamma^k + w_\gamma^{-k}}, \quad \text{where } z = \frac{w + w^{-1}}{2}$$

is close to the optimal polynomial. More specifically, Chebyshev polynomials are *asymptotically* optimal.

For a more general ellipse $E(c, d, a)$ centered at c , and with focal distance d and semi-major axis a , a simple change of variables shows that the near-best polynomial is given by

$$\hat{C}_k(z) = \frac{C_k\left(\frac{c-z}{d}\right)}{C_k\left(\frac{c-\gamma}{d}\right)}. \quad (6.98)$$

In addition, by examining the expression $(w^k + w^{-k})/2$ for $w = \rho e^{i\theta}$ it is easily seen that the maximum modulus of $\hat{C}_k(z)$, i.e., the infinity norm of this polynomial over the ellipse, is reached at the point $c + a$ located on the real axis. From this we get,

$$\max_{z \in E(c, d, a)} |\hat{C}_k(z)| = \frac{C_k\left(\frac{a}{d}\right)}{|C_k\left(\frac{c-\gamma}{d}\right)|}$$

Here, we point out that d and a both can be purely imaginary [for an example, see part (B) of Figure 6.3]. In this case a/d is real and the numerator in the above expression is always real. Using the definition for C_k we obtain the following useful expression and approximation:

$$\frac{C_k\left(\frac{a}{d}\right)}{C_k\left(\frac{c-\gamma}{d}\right)} = \frac{\left(\frac{a}{d} + \sqrt{\left(\frac{a}{d}\right)^2 - 1}\right)^k + \left(\frac{a}{d} + \sqrt{\left(\frac{a}{d}\right)^2 - 1}\right)^{-k}}{\left(\frac{c-\gamma}{d} + \sqrt{\left(\frac{c-\gamma}{d}\right)^2 - 1}\right)^k + \left(\frac{c-\gamma}{d} + \sqrt{\left(\frac{c-\gamma}{d}\right)^2 - 1}\right)^{-k}} \quad (6.99)$$

$$\approx \left(\frac{a + \sqrt{a^2 - d^2}}{c - \gamma + \sqrt{(c - \gamma)^2 - d^2}}\right)^k \quad (6.100)$$

Finally, we note that an alternative and more detailed result has been proven by Fischer and Freund in [89].

6.11.3 CONVERGENCE OF THE CG ALGORITHM

As usual, $\|x\|_A$ denotes the norm defined by

$$\|x\|_A = (Ax, x)^{1/2}.$$

The following lemma characterizes the approximation obtained from the Conjugate Gradient algorithm.

LEMMA 6.5 *Let x_m be the approximate solution obtained from the m -th step of the CG algorithm, and let $d_m = x_* - x_m$ where x_* is the exact solution. Then, x_m is of the form*

$$x_m = x_0 + q_m(A)r_0$$

where q_m is a polynomial of degree $m - 1$ such that

$$\|(I - Aq_m(A))d_0\|_A = \min_{q \in \mathbb{P}_{m-1}} \|(I - Aq(A))d_0\|_A.$$

Proof. This is a consequence of the fact that x_m minimizes the A -norm of the error in the affine subspace $x_0 + \mathcal{K}_m$, a result of Proposition 5.2, and the fact that \mathcal{K}_m is the set of all vectors of the form $x_0 + q(A)r_0$, where q is a polynomial of degree $\leq m - 1$. ■

From this, the following theorem can be proved.

THEOREM 6.6 *Let x_m be the approximate solution obtained at the m -th step of the Conjugate Gradient algorithm, and x_* the exact solution and define*

$$\eta = \frac{\lambda_{min}}{\lambda_{max} - \lambda_{min}}. \quad (6.101)$$

Then,

$$\|x_* - x_m\|_A \leq \frac{\|x_* - x_0\|_A}{C_m(1 + 2\eta)}, \quad (6.102)$$

in which C_m is the Chebyshev polynomial of degree m of the first kind.

Proof. From the previous lemma, it is known that $\|x_* - x_m\|_A$ minimizes A -norm of the error over polynomials $r(t)$ which take the value one at 0, i.e.,

$$\|x_* - x_m\|_A = \min_{r \in \mathbb{P}_m, r(0)=1} \|r(A)d_0\|_A.$$

If $\lambda_i, i = 1, \dots, n$ are the eigenvalues of A , and $\xi_i, i = 1, \dots, n$ the components of the initial error d_0 in the eigenbasis, then

$$\begin{aligned} \|r(A)d_0\|_A^2 &= \sum_{i=1}^n \lambda_i r(\lambda_i)^2 (\xi_i)^2 \leq \max_i (r(\lambda_i))^2 \|d_0\|_A^2 \\ &\leq \max_{\lambda \in [\lambda_{min}, \lambda_{max}]} (r(\lambda))^2 \|d_0\|_A^2. \end{aligned}$$

Therefore,

$$\|x_* - x_m\|_A \leq \min_{r \in \mathbb{P}_m, r(0)=1} \max_{\lambda \in [\lambda_{min}, \lambda_{max}]} |r(\lambda)| \|d_0\|_A.$$

The result follows immediately by using the well known result of Theorem 6.4 from approximation theory. This gives the polynomial r which minimizes the right-hand side. ■

A slightly different formulation of inequality (6.102) can be derived. Using the relation,

$$\begin{aligned} C_m(t) &= \frac{1}{2} \left[\left(t + \sqrt{t^2 - 1} \right)^m + \left(t + \sqrt{t^2 - 1} \right)^{-m} \right] \\ &\geq \frac{1}{2} \left(t + \sqrt{t^2 - 1} \right)^m \end{aligned}$$

then

$$\begin{aligned} C_m(1 + 2\eta) &\geq \frac{1}{2} \left(1 + 2\eta + \sqrt{(1 + 2\eta)^2 - 1} \right)^m \\ &\geq \frac{1}{2} \left(1 + 2\eta + 2\sqrt{\eta(\eta + 1)} \right)^m. \end{aligned}$$

Now notice that

$$1 + 2\eta + 2\sqrt{\eta(\eta + 1)} = \left(\sqrt{\eta} + \sqrt{\eta + 1}\right)^2 \quad (6.103)$$

$$= \frac{(\sqrt{\lambda_{min}} + \sqrt{\lambda_{max}})^2}{\lambda_{max} - \lambda_{min}} \quad (6.104)$$

$$= \frac{\sqrt{\lambda_{max}} + \sqrt{\lambda_{min}}}{\sqrt{\lambda_{max}} - \sqrt{\lambda_{min}}} \quad (6.105)$$

$$= \frac{\sqrt{\kappa} + 1}{\sqrt{\kappa} - 1} \quad (6.106)$$

in which κ is the spectral condition number $\kappa = \lambda_{max}/\lambda_{min}$.

Substituting this in (6.102) yields,

$$\|x_* - x_m\|_A \leq 2 \left[\frac{\sqrt{\kappa} - 1}{\sqrt{\kappa} + 1} \right]^m \|x_* - x_0\|_A. \quad (6.107)$$

This bound is similar to that of the steepest descent algorithm except that the condition number of A is now replaced by its square root.

6.11.4 CONVERGENCE OF GMRES

We begin by stating a *global* convergence result. Recall that a matrix A is called positive definite if its symmetric part $(A + A^T)/2$ is Symmetric Positive Definite. This is equivalent to the property that $(Ax, x) > 0$ for all nonzero real vectors x .

THEOREM 6.7 *If A is a positive definite matrix, then GMRES(m) converges for any $m \geq 1$.*

Proof. This is true because the subspace \mathcal{K}_m contains the initial residual vector at each restart. Since the algorithm minimizes the residual norm in the subspace \mathcal{K}_m , at each outer iteration, the residual norm will be reduced by as much as the result of one step of the Minimal Residual method seen in the previous chapter. Therefore, the inequality (5.18) is satisfied by residual vectors produced after each outer iteration and the method converges. ■

Next we wish to establish a result similar to the one for the Conjugate Gradient method, which would provide an upper bound on the convergence rate of the GMRES iterates. We begin with a lemma similar to Lemma 6.5.

LEMMA 6.6 *Let x_m be the approximate solution obtained from the m -th step of the GMRES algorithm, and let $r_m = b - Ax_m$. Then, x_m is of the form*

$$x_m = x_0 + q_m(A)r_0$$

and

$$\|r_m\|_2 = \|(I - Aq_m(A))r_0\|_2 = \min_{q \in \mathbb{P}_{m-1}} \|(I - Aq(A))r_0\|_2.$$

Proof. This is true because x_m minimizes the 2-norm of the residual in the affine subspace $x_0 + \mathcal{K}_m$, a result of Proposition 5.3, and the fact that \mathcal{K}_m is the set of all vectors of the form $x_0 + q(A)r_0$, where q is a polynomial of degree $\leq m - 1$. ■

Unfortunately, it not possible to prove a simple result such as Theorem 6.6 unless A is normal.

PROPOSITION 6.15 *Assume that A is a diagonalizable matrix and let $A = X\Lambda X^{-1}$ where $\Lambda = \text{diag} \{\lambda_1, \lambda_2, \dots, \lambda_n\}$ is the diagonal matrix of eigenvalues. Define,*

$$\epsilon^{(m)} = \min_{p \in \mathbb{P}_m, p(0)=1} \max_{i=1, \dots, n} |p(\lambda_i)|.$$

Then, the residual norm achieved by the m -th step of GMRES satisfies the inequality

$$\|r_m\|_2 \leq \kappa_2(X) \epsilon^{(m)} \|r_0\|_2.$$

where $\kappa_2(X) \equiv \|X\|_2 \|X^{-1}\|_2$.

Proof. Let p be any polynomial of degree $\leq m$ which satisfies the constraint $p(0) = 1$, and x the vector in \mathcal{K}_m to which it is associated via $b - Ax = p(A)r_0$. Then,

$$\|b - Ax\|_2 = \|Xp(\Lambda)X^{-1}r_0\|_2 \leq \|X\|_2 \|X^{-1}\|_2 \|r_0\|_2 \|p(\Lambda)\|_2$$

Since Λ is diagonal, observe that

$$\|p(\Lambda)\|_2 = \max_{i=1, \dots, n} |p(\lambda_i)|.$$

Since x_m minimizes the residual norm over $x_0 + \mathcal{K}_m$, then for any consistent polynomial p ,

$$\|b - Ax_m\| \leq \|b - Ax\|_2 \leq \|X\|_2 \|X^{-1}\|_2 \|r_0\|_2 \max_{i=1, \dots, n} |p(\lambda_i)|.$$

Now the polynomial p which minimizes the right-hand side in the above inequality can be used. This yields the desired result,

$$\|b - Ax_m\| \leq \|b - Ax\|_2 \leq \|X\|_2 \|X^{-1}\|_2 \|r_0\|_2 \epsilon^{(m)}.$$

■

The results of Section 6.11.2 on near-optimal Chebyshev polynomials in the complex plane can now be used to obtain an upper bound for $\epsilon^{(m)}$. Assume that the spectrum of A is contained in an ellipse $E(c, d, a)$ with center c , focal distance d , and major semi axis a . In addition it is required that the origin lie outside this ellipse. The two possible cases are shown in Figure 6.3. Case (B) corresponds to the situation when d is purely imaginary, i.e., the major semi-axis is aligned with the imaginary axis.

COROLLARY 6.1 *Let A be a diagonalizable matrix, i.e, let $A = X\Lambda X^{-1}$ where $\Lambda = \text{diag} \{\lambda_1, \lambda_2, \dots, \lambda_n\}$ is the diagonal matrix of eigenvalues. Assume that all the eigenvalues of A are located in the ellipse $E(c, d, a)$ which excludes the origin. Then, the*

residual norm achieved at the m -th step of GMRES satisfies the inequality,

$$\|r_m\|_2 \leq \kappa_2(X) \frac{C_m\left(\frac{a}{d}\right)}{\left|C_m\left(\frac{c}{d}\right)\right|} \|r_0\|_2.$$

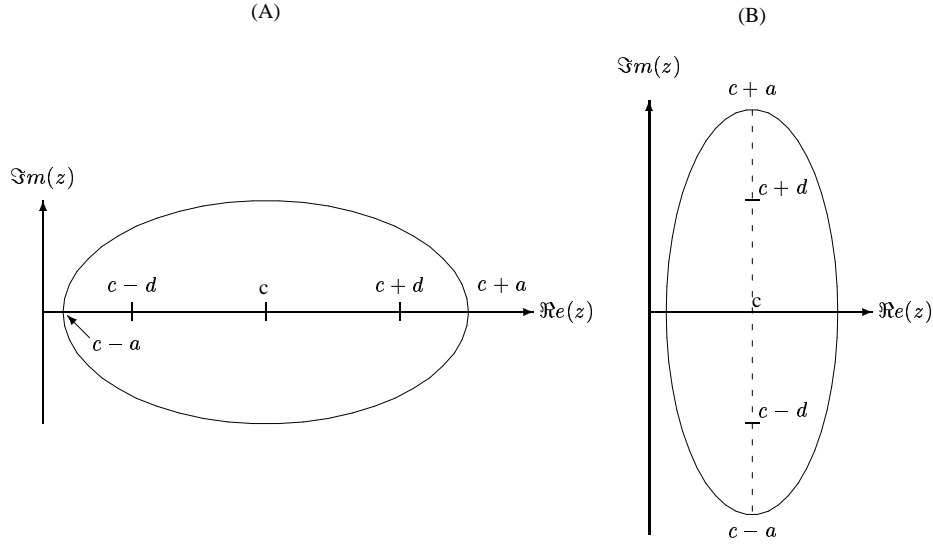

Figure 6.3 Ellipses containing the spectrum of A . Case (A): real d ; case (B): purely imaginary d .

Proof. All that is needed is an upper bound for the scalar $\epsilon^{(m)}$ under the assumptions. By definition,

$$\begin{aligned} \epsilon^{(m)} &= \min_{p \in \mathbb{P}_m, p(0)=1} \max_{i=1, \dots, n} |p(\lambda_i)| \\ &\leq \min_{p \in \mathbb{P}_m, p(0)=1} \max_{\lambda \in E(c, d, a)} |p(\lambda)|. \end{aligned}$$

The second inequality is due to the fact that the maximum modulus of a complex analytical function is reached on the boundary of the domain. We can now use as a trial polynomial \hat{C}_m defined by (6.98), with $\gamma = 0$:

$$\begin{aligned} \epsilon^{(m)} &\leq \min_{p \in \mathbb{P}_m, p(0)=1} \max_{\lambda \in E(c, d, a)} |p(\lambda)| \\ &\leq \max_{\lambda \in E(c, d, a)} |\hat{C}_m(\lambda)| = \frac{C_m\left(\frac{a}{d}\right)}{\left|C_m\left(\frac{c}{d}\right)\right|}. \end{aligned}$$

This completes the proof. ■

An explicit expression for the coefficient $C_m \left(\frac{a}{d} \right) / C_m \left(\frac{c}{d} \right)$ and an approximation are readily obtained from (6.99-6.100) by taking $\gamma = 0$:

$$\begin{aligned} \frac{C_m \left(\frac{a}{d} \right)}{C_m \left(\frac{c}{d} \right)} &= \frac{\left(\frac{a}{d} + \sqrt{\left(\frac{a}{d} \right)^2 - 1} \right)^k + \left(\frac{a}{d} + \sqrt{\left(\frac{a}{d} \right)^2 - 1} \right)^{-k}}{\left(\frac{c}{d} + \sqrt{\left(\frac{c}{d} \right)^2 - 1} \right)^k + \left(\frac{c}{d} + \sqrt{\left(\frac{c}{d} \right)^2 - 1} \right)^{-k}} \\ &\approx \left(\frac{a + \sqrt{a^2 - d^2}}{c + \sqrt{c^2 - d^2}} \right)^k. \end{aligned}$$

Since the condition number $\kappa_2(X)$ of the matrix of eigenvectors X is typically not known and can be very large, results of the nature of the corollary are of limited practical interest. They can be useful only when it is known that the matrix is nearly normal, in which case, $\kappa_2(X) \approx 1$.

BLOCK KRYLOV METHODS

6.12

In many circumstances, it is desirable to work with a block of vectors instead of a single vector. For example, out-of-core finite-element codes are more efficient when they are programmed to exploit the presence of a block of the matrix A in fast memory, as much as possible. This can be achieved by using block generalizations of Krylov subspace methods, for which A always operates on a group of vectors instead of a single vector. We begin by describing a block version of the Arnoldi algorithm.

ALGORITHM 6.21: Block Arnoldi

1. Choose a unitary matrix V_1 of dimension $n \times p$.
 2. For $j = 1, 2, \dots, m$ Do:
 3. Compute $H_{ij} = V_i^T A V_j \quad i = 1, 2, \dots, j$
 4. Compute $W_j = A V_j - \sum_{i=1}^j V_i H_{ij}$
 5. Compute the Q-R factorization of W_j : $W_j = V_{j+1} H_{j+1,j}$
 6. EndDo
-

The above algorithm is a straightforward block analogue of Algorithm 6.1. By construction, the blocks generated by the algorithm are orthogonal blocks that are also orthogonal to each other. In the following we denote by I_k the $k \times k$ identity matrix and use the following notation:

$$\begin{aligned} U_m &= [V_1, V_2, \dots, V_m], \\ H_m &= (H_{ij})_{1 \leq i, j \leq m}, \quad H_{ij} \equiv 0, \quad \text{for } i > j + 1, \\ E_m &= \text{matrix of the last } p \text{ columns of } I_n. \end{aligned}$$

Then, the following analogue of the relation (6.4) is easily proved:

$$AU_m = U_m H_m + V_{m+1} H_{m+1,m} E_m^T. \quad (6.108)$$

Here, the matrix H_m is no longer Hessenberg, but band-Hessenberg, meaning that it has p subdiagonals instead of only one. Note that the dimension of the subspace in which the solution is sought is not m but $m \cdot p$.

A second version of the algorithm uses a modified block Gram-Schmidt procedure instead of the simple Gram-Schmidt procedure used above. This leads to a block generalization of Algorithm 6.2, the Modified Gram-Schmidt version of Arnoldi's method.

ALGORITHM 6.22: Block Arnoldi with Block MGS

1. Choose a unitary matrix V_1 of size $n \times p$
 2. For $j = 1, 2, \dots, m$ Do:
 3. Compute $W_j := AV_j$
 4. For $i = 1, 2, \dots, j$ do:
 5. $H_{ij} := V_i^T W_j$
 6. $W_j := W_j - V_i H_{ij}$
 7. EndDo
 8. Compute the Q-R decomposition $W_j = V_{j+1} H_{j+1,j}$
 9. EndDo
-

Again, in practice the above algorithm is more viable than its predecessor. Finally, a third version, developed by A. Ruhe [170] for the symmetric case (block Lanczos), yields a variant that is quite similar to the original Arnoldi algorithm. Assume that the initial block of p orthonormal vectors, v_1, \dots, v_p is available. The first step of the algorithm is to multiply v_1 by A and orthonormalize the resulting vector w against v_1, \dots, v_p . The resulting vector is defined to be v_{p+1} . In the second step it is v_2 that is multiplied by A and orthonormalized against all available v_i 's. Thus, the algorithm works similarly to Algorithm 6.2 except for a delay in the vector that is multiplied by A at each step.

ALGORITHM 6.23: Block Arnoldi–Ruhe's variant

1. Choose p initial orthonormal vectors $\{v_i\}_{i=1, \dots, p}$.
 2. For $j = p, p+1, \dots, m$ Do:
 3. Set $k := j - p + 1$;
 4. Compute $w := Av_k$;
 5. For $i = 1, 2, \dots, j$ Do:
 6. $h_{i,k} := (w, v_i)$
 7. $w := w - h_{i,k} v_i$
 8. EndDo
 9. Compute $h_{j+1,k} := \|w\|_2$ and $v_{j+1} := w/h_{j+1,k}$.
 10. EndDo
-

Observe that the particular case $p = 1$ coincides with the usual Arnoldi process. Also, the dimension m of the subspace of approximants, is no longer restricted to being a multiple

of the block-size p as in the previous algorithms. The mathematical equivalence of Algorithms 6.22 and 6.23 when m is a multiple of p is straightforward to show. The advantage of the above formulation is its simplicity. A slight disadvantage is that it gives up some potential parallelism. In the original version, the columns of the matrix AV_j can be computed in parallel whereas in the new algorithm, they are computed in sequence. This can be remedied, however, by performing p matrix-by-vector products every p steps.

At the end of the loop consisting of lines 5 through 8 of Algorithm 6.23, the vector w satisfies the relation

$$w = Av_k - \sum_{i=1}^j h_{ik} v_i,$$

where k and j are related by $k = j - p + 1$. Line 9 gives $w = h_{j+1,k} v_{j+1}$ which results in

$$Av_k = \sum_{i=1}^{k+p} h_{ik} v_i.$$

As a consequence, the analogue of the relation (6.5) for Algorithm 6.23 is

$$AV_m = V_{m+p} \bar{H}_m. \tag{6.109}$$

As before, for any j the matrix V_j represents the $n \times j$ matrix with columns v_1, \dots, v_j . The matrix \bar{H}_m is now of size $(m + p) \times m$.

Now the block generalizations of FOM and GMRES can be defined in a straightforward way. These block algorithms can solve linear systems with multiple right-hand sides,

$$Ax^{(i)} = b^{(i)}, \quad i = 1, \dots, p, \tag{6.110}$$

or, in matrix form

$$AX = B, \tag{6.111}$$

where the columns of the $n \times p$ matrices B and X are the $b^{(i)}$'s and $x^{(i)}$'s, respectively. Given an initial block of initial guesses $x_0^{(i)}$ for $i = 1, \dots, p$, we define R_0 the block of initial residuals

$$R_0 \equiv [r_0^{(1)}, r_0^{(2)}, \dots, r_0^{(p)}],$$

where each column is $r_0^{(i)} = b^{(i)} - Ax_0^{(i)}$. It is preferable to use the unified notation derived from Algorithm 6.23. In this notation, m is not restricted to being a multiple of the block-size p and the same notation is used for the v_i 's as in the scalar Arnoldi Algorithm. Thus, the first step of the block-FOM or block-GMRES algorithm is to compute the QR factorization of the block of initial residuals:

$$R_0 = [v_1, v_2, \dots, v_p] R.$$

Here, the matrix $[v_1, \dots, v_p]$ is unitary and R is $p \times p$ upper triangular. This factorization provides the first p vectors of the block-Arnoldi basis.

Each of the approximate solutions has the form

$$x^{(i)} = x_0^{(i)} + V_m y^{(i)}, \tag{6.112}$$

and, grouping these approximations $x^{(i)}$ in a block X and the $y^{(i)}$ in a block Y , we can

write

$$X = X_0 + V_m Y. \quad (6.113)$$

It is now possible to imitate what was done for the standard FOM and GMRES algorithms. The only missing link is the vector βe_1 in (6.21) which now becomes a matrix. Let E_1 be the $(m+p) \times p$ matrix whose upper $p \times p$ principal block is an identity matrix. Then, the relation (6.109) results in

$$\begin{aligned} B - AX &= B - A(X_0 + V_m Y) \\ &= R_0 - AV_m Y \\ &= [v_1, \dots, v_p]R - V_{m+p} \bar{H}_m Y \\ &= V_{m+p} (E_1 R - \bar{H}_m Y). \end{aligned} \quad (6.114)$$

The vector

$$\bar{g}^{(i)} \equiv E_1 R e_i$$

is a vector of length $m+p$ whose components are zero except those from 1 to i which are extracted from the i -th column of the upper triangular matrix R . The matrix \bar{H}_m is an $(m+p) \times m$ matrix. The block-FOM approximation would consist of deleting the last p rows of $\bar{g}^{(i)}$ and \bar{H}_m and solving the resulting system,

$$H_m y^{(i)} = g^{(i)}.$$

The approximate solution $x^{(i)}$ is then computed by (6.112).

The block-GMRES approximation $x^{(i)}$ is the unique vector of the form $x_0^{(i)} + V_m y^{(i)}$ which minimizes the 2-norm of the individual columns of the block-residual (6.114). Since the column-vectors of V_{m+p} are orthonormal, then from (6.114) we get,

$$\|b^{(i)} - Ax^{(i)}\|_2 = \|\bar{g}^{(i)} - \bar{H}_m y^{(i)}\|_2. \quad (6.115)$$

To minimize the residual norm, the function on the right hand-side must be minimized over $y^{(i)}$. The resulting least-squares problem is similar to the one encountered for GMRES. The only differences are in the right-hand side and the fact that the matrix is no longer Hessenberg, but band-Hessenberg. Rotations can be used in a way similar to the scalar case. However, p rotations are now needed at each new step instead of only one. Thus, if $m = 6$ and $p = 2$, the matrix \bar{H}_6 and block right-hand side would be as follows:

$$\bar{H}_8 = \begin{pmatrix} h_{11} & h_{12} & h_{13} & h_{14} & h_{15} & h_{16} \\ h_{21} & h_{22} & h_{23} & h_{24} & h_{25} & h_{26} \\ h_{31} & h_{32} & h_{33} & h_{34} & h_{35} & h_{36} \\ & h_{42} & h_{43} & h_{44} & h_{45} & h_{46} \\ & & h_{53} & h_{54} & h_{55} & h_{56} \\ & & & h_{64} & h_{65} & h_{66} \\ & & & & h_{75} & h_{76} \\ & & & & & h_{86} \end{pmatrix} \quad \bar{G} = \begin{pmatrix} g_{11} & g_{12} \\ & g_{22} \end{pmatrix}.$$

For each new column generated in the block-Arnoldi process, p rotations are required to eliminate the elements $h_{k,j}$, for $k = j+p$ down to $k = j+1$. This backward order is important. In the above example, a rotation is applied to eliminate $h_{3,1}$ and then a second rotation is used to eliminate the resulting $h_{2,1}$, and similarly for the second, third step, etc.

This complicates programming slightly since two-dimensional arrays must now be used to save the rotations instead of one-dimensional arrays in the scalar case. After the first column of \tilde{H}_m is processed, the block of right-hand sides will have a diagonal added under the diagonal of the upper triangular matrix. Specifically, the above two matrices will have the structure,

$$\tilde{H}_8 = \begin{pmatrix} * & * & * & * & * & * \\ & * & * & * & * & * \\ & & * & * & * & * \\ & & & * & * & * \\ & & & & * & * \\ & & & & & * \\ & & & & & & * \\ & & & & & & & * \end{pmatrix} \quad \tilde{G} = \begin{pmatrix} * & * \\ * & * \\ * & * \\ * & * \\ * & * \\ * & * \\ * & * \\ * & * \end{pmatrix},$$

where a $*$ represents a nonzero element. After all columns are processed, the following least-squares system is obtained.

$$\tilde{H}_8 = \begin{pmatrix} * & * & * & * & * & * \\ & * & * & * & * & * \\ & & * & * & * & * \\ & & & * & * & * \\ & & & & * & * \\ & & & & & * \\ & & & & & & * \\ & & & & & & & * \\ \hline & & & & & & & * \end{pmatrix} \quad \tilde{G} = \begin{pmatrix} * & * \\ * & * \\ * & * \\ * & * \\ * & * \\ * & * \\ * & * \\ * & * \\ \hline * & * \\ * & * \end{pmatrix}.$$

To obtain the least-squares solutions for each right-hand side, ignore anything below the horizontal lines in the above matrices and solve the resulting triangular systems. The residual norm of the i -th system for the original problem is the 2-norm of the vector consisting of the components $m + 1$, through $m + i$ in the i -th column of the above block of right-hand sides.

Generally speaking, the block methods are of great practical value in applications involving linear systems with multiple right-hand sides. However, they are not as well studied from the theoretical point of view. Perhaps, one of the reasons is the lack of a convincing analogue for the relationship with orthogonal polynomials, established in subsection 6.6.2 for the single-vector Lanczos algorithm. The block version of the Lanczos algorithm has not been covered but the generalization is straightforward.

EXERCISES

1. In the Householder implementation of the Arnoldi algorithm, show the following points of detail:
 - a. Q_{j+1} is unitary and its inverse is Q_{j+1}^T .
 - b. $Q_{j+1}^T = P_1 P_2 \dots P_{j+1}$.

- c. $Q_{j+1}^T e_i = v_i$ for $i < j$.
- d. $Q_{j+1} A V_m = V_{m+1} [e_1, e_2, \dots, e_{j+1}] \bar{H}_m$, where e_i is the i -th column of the $n \times n$ identity matrix.
- e. The v_i 's are orthonormal.
- f. The vectors v_1, \dots, v_j are equal to the Arnoldi vectors produced by the Gram-Schmidt version, except possibly for a scaling factor.
2. Rewrite the Householder implementation of the Arnoldi algorithm with more detail. In particular, define precisely the Householder vector w_j used at step j (lines 3-5).
 3. Consider the Householder implementation of the Arnoldi algorithm. Give a detailed operation count of the algorithm and compare it with the Gram-Schmidt and Modified Gram-Schmidt algorithm.
 4. Derive the basic version of GMRES by using the standard formula (5.7) with $V = V_m$ and $W = A V_m$.
 5. Derive a version of the DIOM algorithm which includes partial pivoting in the solution of the Hessenberg system.
 6. Show how the GMRES and FOM methods will converge on the linear system $Ax = b$ when

$$A = \begin{pmatrix} & & & 1 \\ 1 & & & \\ & 1 & & \\ & & 1 & \\ & & & 1 \end{pmatrix}, \quad b = \begin{pmatrix} 1 \\ 0 \\ 0 \\ 0 \\ 0 \end{pmatrix}$$

and with $x_0 = 0$.

7. Give a full proof of Proposition 6.11.
8. Let a matrix A have the form

$$A = \begin{pmatrix} I & Y \\ 0 & I \end{pmatrix}.$$

Assume that (full) GMRES is used to solve a linear system, with the coefficient matrix A . What is the maximum number of steps that GMRES would require to converge?

9. Let a matrix A have the form:

$$A = \begin{pmatrix} I & Y \\ 0 & S \end{pmatrix}.$$

Assume that (full) GMRES is used to solve a linear system with the coefficient matrix A . Let

$$r_0 = \begin{pmatrix} r_0^{(1)} \\ r_0^{(2)} \\ r_0 \end{pmatrix}$$

be the initial residual vector. It is assumed that the degree of the minimal polynomial of $r_0^{(2)}$ with respect to S (i.e., its grade) is k . What is the maximum number of steps that GMRES would require to converge for this matrix? [Hint: Evaluate the sum $\sum_{i=0}^k \beta_i (A^{i+1} - A^i) r_0$ where $\sum_{i=0}^k \beta_i t^i$ is the minimal polynomial of $r_0^{(2)}$ with respect to S .]

10. Let

$$A = \begin{pmatrix} I & Y_2 & & & & & \\ & I & Y_3 & & & & \\ & & & \ddots & & & \\ & & & & I & Y_{k-1} & \\ & & & & & I & Y_k \\ & & & & & & I \end{pmatrix}.$$

- a. Show that $(I - A)^k = 0$.
 - b. Assume that (full) GMRES is used to solve a linear system with the coefficient matrix A . What is the maximum number of steps that GMRES would require to converge?
11. Show that if H_m is nonsingular, i.e., x_m^F is defined, and if $x_m^G = x_m^F$, then $r_m^G = r_m^F = 0$, i.e., both the GMRES and FOM solutions are exact. [Hint: use the relation (6.46) and Proposition 6.11 or Proposition 6.12.]
12. Derive the relation (6.49) from (6.47). [Hint: Use the fact that the vectors on the right-hand side of (6.47) are orthogonal.]
13. In the Householder-GMRES algorithm the approximate solution can be computed by formulas (6.25-6.27). What is the exact cost of this alternative (compare memory as well as arithmetic requirements)? How does it compare with the cost of keeping the v_i 's?
14. An alternative to formulas (6.25-6.27) for accumulating the approximate solution in the Householder-GMRES algorithm without keeping the v_i 's is to compute x_m as

$$x_m = x_0 + P_1 P_2 \dots P_m y$$

where y is a certain n -dimensional vector to be determined. (1) What is the vector y for the above formula in order to compute the correct approximate solution x_m ? [Hint: Exploit (6.11).] (2) Write down an alternative to formulas (6.25-6.27) derived from this approach. (3) Compare the cost of this approach with the cost of using (6.25-6.27).

- 15. Obtain the formula (6.76) from (6.75).
- 16. Show that the determinant of the matrix T_m in (6.82) is given by

$$\det (T_m) = \frac{1}{\prod_{i=0}^{m-1} \alpha_i}$$

- 17. The Lanczos algorithm is more closely related to the implementation of Algorithm 6.18 of the Conjugate Gradient algorithm. As a result the Lanczos coefficients δ_{j+1} and η_{j+1} are easier to extract from this algorithm than from Algorithm 6.17. Obtain formulas for these coefficients from the coefficients generated by Algorithm 6.18, as was done in Section 6.7.3 for the standard CG algorithm.
- 18. Show that if the rotations generated in the course of the GMRES (and DQGMRES) algorithm are such that

$$|c_m| \geq c > 0,$$
 then GMRES, DQGMRES, and FOM will all converge.
- 19. Show the exact expression of the residual vector in the basis v_1, v_2, \dots, v_{m+1} for either GMRES or DQGMRES. [Hint: A starting point is (6.52).]
- 20. Prove that the inequality (6.56) is sharper than (6.53), in the sense that $\zeta_{m+1} \leq \sqrt{m - k + 11}$ (for $m \geq k$). [Hint: Use Cauchy-Schwarz inequality on (6.56).]

21. Denote by S_m the unit upper triangular matrix S in the proof of Theorem 6.1 which is obtained from the Gram-Schmidt process (exact arithmetic assumed) applied to the incomplete orthogonalization basis V_m . Show that the Hessenberg matrix \bar{H}_m^Q obtained in the incomplete orthogonalization process is related to the Hessenberg matrix \bar{H}_m^G obtained from the (complete) Arnoldi process by

$$\bar{H}_m^G = S_{m+1}^{-1} \bar{H}_m^Q S_m.$$

NOTES AND REFERENCES. Lemma 6.1 was proved by Roland Freund [95] in a slightly different form. Proposition 6.12 is due to Brown [43] who proved a number of other theoretical results, including Proposition 6.11. Recently, Cullum and Greenbaum [63] discussed further relationships between FOM and GMRES and other Krylov subspace methods.

The Conjugate Gradient method was developed independently and in different forms by Lanczos [142] and Hestenes and Stiefel [120]. The method was essentially viewed as a direct solution technique and was abandoned early on because it did not compare well with other existing techniques. For example, in inexact arithmetic, the method does not terminate in n steps as is predicted by the theory. This is caused by the severe loss of orthogonality of vector quantities generated by the algorithm. As a result, research on Krylov-type methods remained dormant for over two decades thereafter. This changed in the early 1970s when several researchers discovered that this loss of orthogonality did not prevent convergence. The observations were made and explained for eigenvalue problems [158, 106] as well as linear systems [167]. The early to the middle 1980s saw the development of a new class of methods for solving nonsymmetric linear systems [13, 14, 127, 172, 173, 185, 218]. The works of Faber and Manteuffel [85] and Voevodin [219] showed that one could not find optimal methods which, like CG, are based on short-term recurrences. Many of the methods developed are mathematically equivalent, in the sense that they realize the same projection process, with different implementations.

The Householder version of GMRES is due to Walker [221]. The Quasi-GMRES algorithm described in Section 6.5.7 was initially described by Brown and Hindmarsh [44], although the direct version DQGMRES was only discussed recently in [187]. The proof of Theorem 6.1 can be found in [152] for the QMR algorithm.

The non-optimality of the Chebyshev polynomials on ellipses in the complex plane was established by Fischer and Freund [90]. Prior to this, a 1963 paper by Clayton [59] was believed to have established the optimality for the special case where the ellipse has real foci and γ is real.

Until recently, little attention has been given to block Krylov methods. In addition to their attraction for solving linear systems with several right-hand sides [177, 196], these techniques can also help reduce the effect of the sequential inner products in parallel environments and minimize I/O costs in out-of-core implementations. The block-GMRES algorithm is analyzed by Simoncini and Gallopoulos [197] and in [184]. Alternatives to GMRES which require fewer inner products have been proposed by Sadok [188] and Jbilou [125]. Sadok investigated a GMRES-like method based on the Hessenberg algorithm [227], while Jbilou proposed a multi-dimensional generalization of Gastinel's method seen in Exercise 2 of Chapter 5. ■

KRYLOV SUBSPACE METHODS PART II

The previous chapter considered a number of Krylov subspace methods which relied on some form of orthogonalization of the Krylov vectors in order to compute an approximate solution. This chapter will describe a class of Krylov subspace methods which are instead based on a biorthogonalization algorithm due to Lanczos. These are projection methods that are intrinsically non-orthogonal. They have some appealing properties, but are harder to analyze theoretically.

LANCZOS BIORTHOGONALIZATION

7.1

The Lanczos biorthogonalization algorithm is an extension to nonsymmetric matrices of the symmetric Lanczos algorithm seen in the previous chapter. One such extension, the Arnoldi procedure, has already been seen. However, the nonsymmetric Lanczos algorithm is quite different in concept from Arnoldi's method because it relies on biorthogonal sequences instead of orthogonal sequences.

7.1.1 THE ALGORITHM

The algorithm proposed by Lanczos for nonsymmetric matrices builds a pair of biorthogonal bases for the two subspaces

$$\mathcal{K}_m(A, v_1) = \text{span}\{v_1, Av_1, \dots, A^{m-1}v_1\}$$

and

$$\mathcal{K}_m(A^T, w_1) = \text{span}\{w_1, A^T w_1, \dots, (A^T)^{m-1}w_1\}.$$

The algorithm that achieves this is the following.

ALGORITHM 7.1: The Lanczos Biorthogonalization Procedure

1. Choose two vectors v_1, w_1 such that $(v_1, w_1) = 1$.
 2. Set $\beta_1 = \delta_1 \equiv 0, w_0 = v_0 \equiv 0$
 3. For $j = 1, 2, \dots, m$ Do:
 4. $\alpha_j = (Av_j, w_j)$
 5. $\hat{v}_{j+1} = Av_j - \alpha_j v_j - \beta_j v_{j-1}$
 6. $\hat{w}_{j+1} = A^T w_j - \alpha_j w_j - \delta_j w_{j-1}$
 7. $\delta_{j+1} = |(\hat{v}_{j+1}, \hat{w}_{j+1})|^{1/2}$. If $\delta_{j+1} = 0$ Stop
 8. $\beta_{j+1} = (\hat{v}_{j+1}, \hat{w}_{j+1})/\delta_{j+1}$
 9. $w_{j+1} = \hat{w}_{j+1}/\beta_{j+1}$
 10. $v_{j+1} = \hat{v}_{j+1}/\delta_{j+1}$
 11. EndDo
-

Note that there are numerous ways to choose the scalars $\delta_{j+1}, \beta_{j+1}$ in lines 7 and 8. These two parameters are scaling factors for the two vectors v_{j+1} and w_{j+1} and can be selected in any manner to ensure that $(v_{j+1}, w_{j+1}) = 1$. As a result of lines 9 and 10 of the algorithm, it is only necessary to choose two scalars $\beta_{j+1}, \delta_{j+1}$ that satisfy the equality

$$\delta_{j+1}\beta_{j+1} = (\hat{v}_{j+1}, \hat{w}_{j+1}). \quad (7.1)$$

The choice taken in the above algorithm scales the two vectors so that they are divided by two scalars which have the same modulus. Both vectors can also be scaled by their 2-norms. In that case, the inner product of v_{j+1} and w_{j+1} is no longer equal to 1 and the algorithm must be modified accordingly; see Exercise 3.

Consider the case where the pair of scalars $\delta_{j+1}, \beta_{j+1}$ is *any pair* that satisfies the relation (7.1). Denote by T_m the tridiagonal matrix

$$T_m = \begin{pmatrix} \alpha_1 & \beta_2 & & & & \\ \delta_2 & \alpha_2 & \beta_3 & & & \\ & \cdot & \cdot & \cdot & & \\ & & \delta_{m-1} & \alpha_{m-1} & \beta_m & \\ & & & \delta_m & \alpha_m & \end{pmatrix}. \quad (7.2)$$

If the determinations of $\beta_{j+1}, \delta_{j+1}$ of lines 7–8 are used, then the δ_j 's are positive and $\beta_j = \pm\delta_j$.

Observe from the algorithm that the vectors v_i belong to $\mathcal{K}_m(A, v_1)$, while the w_j 's are in $\mathcal{K}_m(A^T, w_1)$. In fact, the following proposition can be proved.

PROPOSITION 7.1 *If the algorithm does not break down before step m , then the vectors $v_i, i = 1, \dots, m$, and $w_j, j = 1, \dots, m$, form a biorthogonal system, i.e.,*

$$(v_j, w_i) = \delta_{ij} \quad 1 \leq i, j \leq m.$$

Moreover, $\{v_i\}_{i=1,2,\dots,m}$ is a basis of $\mathcal{K}_m(A, v_1)$ and $\{w_i\}_{i=1,2,\dots,m}$ is a basis of $\mathcal{K}_m(A^T, w_1)$ and the following relations hold,

$$AV_m = V_m T_m + \delta_{m+1} v_{m+1} e_m^T, \quad (7.3)$$

$$A^T W_m = W_m T_m^T + \beta_{m+1} w_{m+1} e_m^T, \quad (7.4)$$

$$W_m^T A V_m = T_m. \quad (7.5)$$

Proof. The biorthogonality of the vectors v_i, w_i will be shown by induction. By assumption $(v_1, w_1) = 1$. Assume now that the vectors v_1, \dots, v_j and w_1, \dots, w_j are biorthogonal, and let us prove that the vectors v_1, \dots, v_{j+1} and w_1, \dots, w_{j+1} are biorthogonal.

First, we show that $(v_{j+1}, w_i) = 0$ for $i \leq j$. When $i = j$, then

$$(v_{j+1}, w_j) = \delta_{j+1}^{-1} [(A v_j, w_j) - \alpha_j (v_j, w_j) - \beta_j (v_{j-1}, w_j)].$$

The last inner product in the above expression vanishes by the induction hypothesis. The two other terms cancel each other by the definition of α_j and the fact that $(v_j, w_j) = 1$. Consider now the inner product (v_{j+1}, w_i) with $i < j$,

$$\begin{aligned} (v_{j+1}, w_i) &= \delta_{j+1}^{-1} [(A v_j, w_i) - \alpha_j (v_j, w_i) - \beta_j (v_{j-1}, w_i)] \\ &= \delta_{j+1}^{-1} [(v_j, A^T w_i) - \beta_j (v_{j-1}, w_i)] \\ &= \delta_{j+1}^{-1} [(v_j, \beta_{i+1} w_{i+1} + \alpha_i w_i + \delta_i w_{i-1}) - \beta_j (v_{j-1}, w_i)]. \end{aligned}$$

For $i < j - 1$, all of the inner products in the above expression vanish, by the induction hypothesis. For $i = j - 1$, the inner product is

$$\begin{aligned} (v_{j+1}, w_{j-1}) &= \delta_{j+1}^{-1} [(v_j, \beta_j w_j + \alpha_{j-1} w_{j-1} + \delta_{j-1} w_{j-2}) - \beta_j (v_{j-1}, w_{j-1})] \\ &= \delta_{j+1}^{-1} [\beta_j (v_j, w_j) - \beta_j (v_{j-1}, w_{j-1})] \\ &= 0. \end{aligned}$$

It can be proved in exactly the same way that $(v_i, w_{j+1}) = 0$ for $i \leq j$. Finally, by construction $(v_{j+1}, w_{j+1}) = 1$. This completes the induction proof. The proof of the matrix relations (7.3–7.5) is similar to that of the relations (6.4–6.6) in Arnoldi's method. ■

The relations (7.3–7.5) allow us to interpret the algorithm. The matrix T_m is the projection of A obtained from an oblique projection process onto $\mathcal{K}_m(A, v_1)$ and orthogonally to $\mathcal{K}_m(A^T, w_1)$. Similarly, T_m^T represents the projection of A^T on $\mathcal{K}_m(A^T, w_1)$ and orthogonally to $\mathcal{K}_m(A, v_1)$. Thus, an interesting new feature here is that the operators A and A^T play a dual role because similar operations are performed with them. In fact, two linear systems are solved implicitly, one with A and the other with A^T . If there were two linear systems to solve, one with A and the other with A^T , then this algorithm is suitable. Otherwise, the operations with A^T are essentially wasted. Later a number of alternative techniques developed in the literature will be introduced that avoid the use of A^T .

From a practical point of view, the Lanczos algorithm has a significant advantage over Arnoldi's method because it requires only a few vectors of storage, if no reorthogonalization is performed. Specifically, six vectors of length n are needed, plus some storage for the tridiagonal matrix, no matter how large m is.

On the other hand, there are potentially more opportunities for breakdown with the nonsymmetric Lanczos method. The algorithm will break down whenever δ_{j+1} as defined in line 7 vanishes. This is examined more carefully in the next section. In practice, the difficulties are more likely to be caused by the near occurrence of this phenomenon. A look at the algorithm indicates that the Lanczos vectors may have to be scaled by small

quantities when this happens. After a few steps the cumulated effect of these scalings may introduce excessive rounding errors.

Since the subspace from which the approximations are taken is identical to that of Arnoldi's method, the same bounds for the distance $\|(I - \Pi_m)u\|_2$ are valid. However, this does not mean in any way that the approximations obtained by the two methods are likely to be similar in quality. The theoretical bounds shown in Chapter 5 indicate that the norm of the projector may play a significant role.

7.1.2 PRACTICAL IMPLEMENTATIONS

There are various ways to improve the standard nonsymmetric Lanczos algorithm which we now discuss briefly. A major concern here is the potential breakdowns or "near breakdowns" in the algorithm. There exist a number of approaches that have been developed to avoid such breakdowns. Other approaches do not attempt to eliminate the breakdown, but rather try to deal with it. The pros and cons of these strategies will be discussed after the various existing scenarios are described.

Algorithm 7.1 will abort in line 7 whenever,

$$(\hat{v}_{j+1}, \hat{w}_{j+1}) = 0. \quad (7.6)$$

This can arise in two different ways. Either one of the two vectors \hat{v}_{j+1} or \hat{w}_{j+1} vanishes, or they are both nonzero, but their inner product is zero. The first case is the "lucky breakdown" scenario which has been seen for symmetric matrices. Thus, if $\hat{v}_{j+1} = 0$ then $\text{span}\{V_j\}$ is invariant and, as was seen in Chapter 5, the approximate solution is exact. If $\hat{w}_{j+1} = 0$ then $\text{span}\{W_j\}$ is invariant. However, in this situation nothing can be said about the approximate solution for the linear system with A . If the algorithm is being used to solve a pair of linear systems, one with A and a *dual* system with A^T , then the approximate solution for the dual system will be exact in this case. The second scenario in which (7.6) can occur is when neither of the two vectors is zero, but their inner product is zero. Wilkinson (see [227], p. 389) called this a *serious breakdown*. Fortunately, there are cures for this problem which allow the algorithm to continue in most cases. The corresponding modifications of the algorithm are often put under the denomination *Look-Ahead Lanczos* algorithms. There are also rare cases of *incurable breakdowns* which will not be discussed here (see references [161] and [206]).

The main idea of Look-Ahead variants of the Lanczos algorithm is that the pair v_{j+2}, w_{j+2} can often be defined even though the pair v_{j+1}, w_{j+1} is not defined. The algorithm can be pursued from that iterate as before until a new breakdown is encountered. If the pair v_{j+2}, w_{j+2} cannot be defined then the pair v_{j+3}, w_{j+3} can be tried, and so on. To better explain the idea, it is best to refer to the connection with orthogonal polynomials mentioned earlier for the symmetric case. The relationship can be extended to the nonsymmetric case by defining the bilinear form on the subspace \mathbb{P}_{m-1}

$$\langle p, q \rangle = (p(A)v_1, q(A^T)w_1). \quad (7.7)$$

Unfortunately, this is now an "indefinite inner product" in general since $\langle p, p \rangle$ can be zero or even negative. Note that there is a polynomial p_j of degree j such that $\hat{v}_{j+1} = p_j(A)v_1$ and, in fact, the same polynomial intervenes in the equivalent expression of w_{j+1} .

More precisely, there is a scalar γ_j such that $\hat{w}_{j+1} = \gamma_j p_j(A^T)v_1$. Similar to the symmetric case, the nonsymmetric Lanczos algorithm attempts to compute a sequence of polynomials that are orthogonal with respect to the indefinite inner product defined above. If we define the moment matrix

$$M_k = \{ \langle x^{i-1}, x^{j-1} \rangle \}_{i,j=1,\dots,k}$$

then this process is mathematically equivalent to the computation of the factorization

$$M_k = L_k U_k$$

of the moment matrix M_k , in which U_k is upper triangular and L_k is lower triangular. Note that M_k is a Hankel matrix, i.e., its coefficients m_{ij} are constant along anti-diagonals, i.e., for $i + j = \text{constant}$.

Because

$$\langle p_j, p_j \rangle = \gamma_j (p_j(A)v_1, p_j(A^T)w_1),$$

we observe that there is a serious breakdown at step j if and only if the indefinite norm of the polynomial p_j at step j vanishes. If this polynomial is skipped, it may still be possible to compute p_{j+1} and continue to generate the sequence. To explain this simply, consider

$$q_j(t) = xp_{j-1}(t) \quad \text{and} \quad q_{j+1}(t) = x^2 p_{j-1}(t).$$

Both q_j and q_{j+1} are orthogonal to the polynomials p_1, \dots, p_{j-2} . We can define (somewhat arbitrarily) $p_j = q_j$, and then p_{j+1} can be obtained by orthogonalizing q_{j+1} against p_{j-1} and p_j . It is clear that the resulting polynomial will then be orthogonal against all polynomials of degree $\leq j$; see Exercise 5. Therefore, the algorithm can be continued from step $j + 1$ in the same manner. Exercise 5 generalizes this for the case where k polynomials are skipped rather than just one. This is a simplified description of the mechanism which underlies the various versions of Look-Ahead Lanczos algorithms proposed in the literature. The Parlett-Taylor-Liu implementation [161] is based on the observation that the algorithm breaks because the pivots encountered during the LU factorization of the moment matrix M_k vanish. Then, divisions by zero are avoided by performing *implicitly* a pivot with a 2×2 matrix rather than using a standard 1×1 pivot.

The drawback of Look-Ahead implementations is the nonnegligible added complexity. Besides the difficulty of identifying these near breakdown situations, the matrix T_m ceases to be tridiagonal. Indeed, whenever a step is skipped, elements are introduced above the superdiagonal positions, in some subsequent step. In the context of linear systems, near breakdowns are rare and their effect generally benign. Therefore, a simpler remedy, such as restarting the Lanczos procedure, may well be adequate. For eigenvalue problems, Look-Ahead strategies may be more justified.

 THE LANCZOS ALGORITHM FOR LINEAR SYSTEMS

7.2

We present in this section a brief description of the Lanczos method for solving nonsymmetric linear systems. Consider the (single) linear system:

$$Ax = b \quad (7.8)$$

where A is $n \times n$ and nonsymmetric. Suppose that a guess x_0 to the solution is available and let its residual vector be $r_0 = b - Ax_0$. Then the Lanczos algorithm for solving (7.8) can be described as follows.

ALGORITHM 7.2: Two-sided Lanczos Algorithm for Linear Systems

1. Compute $r_0 = b - Ax_0$ and $\beta := \|r_0\|_2$
 2. Run m steps of the nonsymmetric Lanczos Algorithm, i.e.,
 3. Start with $v_1 := r_0/\beta$, and any w_1 such that $(v_1, w_1) = 1$
 4. Generate the Lanczos vectors $v_1, \dots, v_m, w_1, \dots, w_m$
 5. and the tridiagonal matrix T_m from Algorithm 7.1.
 6. Compute $y_m = T_m^{-1}(\beta e_1)$ and $x_m := x_0 + V_m y_m$.
-

Note that it is possible to incorporate a convergence test when generating the Lanczos vectors in the second step without computing the approximate solution explicitly. This is due to the following formula, which is similar to Equation (6.66) for the symmetric case,

$$\|b - Ax_j\|_2 = |\delta_{j+1} e_j^T y_j| \|v_{j+1}\|_2, \quad (7.9)$$

and which can be proved in the same way, by using (7.3). This formula gives us the residual norm inexpensively without generating the approximate solution itself.

 THE BCG AND QMR ALGORITHMS

7.3

The Biconjugate Gradient (BCG) algorithm can be derived from Algorithm 7.1 in exactly the same way as the Conjugate Gradient method was derived from Algorithm 6.14. The algorithm was first proposed by Lanczos [142] in 1952 and then in a different form (Conjugate Gradient-like version) by Fletcher [92] in 1974. Implicitly, the algorithm solves not only the original system $Ax = b$ but also a dual linear system $A^T x^* = b^*$ with A^T . This dual system is often ignored in the formulations of the algorithm.

7.3.1 THE BICONJUGATE GRADIENT ALGORITHM

The Biconjugate Gradient (BCG) algorithm is a projection process onto

$$\mathcal{K}_m = \text{span}\{v_1, Av_1, \dots, A^{m-1}v_1\}$$

orthogonally to

$$\mathcal{L}_m = \text{span}\{w_1, A^T w_1, \dots, (A^T)^{m-1}w_1\}$$

taking, as usual, $v_1 = r_0/\|r_0\|_2$. The vector w_1 is arbitrary, provided $(v_1, w_1) \neq 0$, but it is often chosen to be equal to v_1 . If there is a dual system $A^T x^* = b^*$ to solve with A^T , then w_1 is obtained by scaling the initial residual $b^* - A^T x_0^*$.

Proceeding in the same manner as for the derivation of the Conjugate Gradient algorithm from the symmetric Lanczos algorithm, we write the LDU decomposition of T_m as

$$T_m = L_m U_m \quad (7.10)$$

and define

$$P_m = V_m U_m^{-1}. \quad (7.11)$$

The solution is then expressed as

$$\begin{aligned} x_m &= x_0 + V_m T_m^{-1}(\beta e_1) \\ &= x_0 + V_m U_m^{-1} L_m^{-1}(\beta e_1) \\ &= x_0 + P_m L_m^{-1}(\beta e_1). \end{aligned}$$

Notice that the solution x_m is updatable from x_{m-1} in a similar way to the Conjugate Gradient algorithm. Like the Conjugate Gradient algorithm, the vectors r_j and r_j^* are in the same direction as v_{j+1} and w_{j+1} , respectively. Hence, they form a biorthogonal sequence. Define similarly the matrix

$$P_m^* = W_m L_m^{-T}. \quad (7.12)$$

Clearly, the column-vectors p_i^* of P_m^* and those p_i of P_m are A-conjugate, since,

$$(P_m^*)^T A P_m = L_m^{-1} W_m^T A V_m U_m^{-1} = L_m^{-1} T_m U_m^{-1} = I.$$

Utilizing this information, a Conjugate Gradient-like algorithm can be easily derived from the Lanczos procedure.

ALGORITHM 7.3: Biconjugate Gradient (BCG)

1. Compute $r_0 := b - Ax_0$. Choose r_0^* such that $(r_0, r_0^*) \neq 0$.
2. Set, $p_0 := r_0, p_0^* := r_0^*$
3. For $j = 0, 1, \dots$, until convergence Do:
 4. $\alpha_j := (r_j, r_j^*) / (Ap_j, p_j^*)$
 5. $x_{j+1} := x_j + \alpha_j p_j$
 6. $r_{j+1} := r_j - \alpha_j Ap_j$
 7. $r_{j+1}^* := r_j^* - \alpha_j A^T p_j^*$
 8. $\beta_j := (r_{j+1}, r_{j+1}^*) / (r_j, r_j^*)$

9. $p_{j+1} := r_{j+1} + \beta_j p_j$
10. $p_{j+1}^* := r_{j+1}^* + \beta_j p_j^*$
11. *EndDo*

If a dual system with A^T is being solved, then in line 1 r_0^* should be defined as $r_0^* = b^* - A^T x_0^*$ and the update $x_{j+1}^* := x_j^* + \alpha_j p_j^*$ to the dual approximate solution must be inserted after line 5. The vectors produced by this algorithm satisfy a few biorthogonality properties stated in the following proposition.

PROPOSITION 7.2 *The vectors produced by the Biconjugate Gradient algorithm satisfy the following orthogonality properties:*

$$(r_j, r_i^*) = 0, \quad \text{for } i \neq j, \quad (7.13)$$

$$(Ap_j, p_i^*) = 0, \quad \text{for } i \neq j. \quad (7.14)$$

Proof. The proof is either by induction or by simply exploiting the relations between the vectors r_j, r_j^*, p_j, p_j^* , and the vector columns of the matrices V_m, W_m, P_m, P_m^* . This is left as an exercise. ■

Example 7.1 Table 7.1 shows the results of applying the BCG algorithm with no preconditioning to three of the test problems described in Section 3.7. See Example 6.1 for the meaning of the column headers in the table. Recall that *Iters* really represents the number of matrix-by-vector multiplications rather than the number of Biconjugate Gradient steps.

Matrix	Iters	Kflops	Residual	Error
F2DA	163	2974	0.17E-03	0.86E-04
F3D	123	10768	0.34E-04	0.17E-03
ORS	301	6622	0.50E-01	0.37E-02

Table 7.1 *A test run of BCG without preconditioning.*

Thus, the number 163 in the first line represents 81 steps of BCG, which require 81×2 matrix-by-vector products in the iteration, and an extra one to compute the initial residual.

7.3.2 QUASI-MINIMAL RESIDUAL ALGORITHM

The result of the Lanczos algorithm is a relation of the form

$$AV_m = V_{m+1} \bar{T}_m \quad (7.15)$$

in which \bar{T}_m is the $(m+1) \times m$ tridiagonal matrix

$$\bar{T}_m = \begin{pmatrix} T_m & \\ & \delta_{m+1} e_m^T \end{pmatrix}.$$

Now (7.15) can be exploited in the same way as was done to develop GMRES. If v_1 is defined as a multiple of r_0 , i.e., if $v_1 = \beta r_0$, then the residual vector associated with an approximate solution of the form

$$x = x_0 + V_m y$$

is given by

$$\begin{aligned} b - Ax &= b - A(x_0 + V_m y) \\ &= r_0 - AV_m y \\ &= \beta v_1 - V_{m+1} \bar{T}_m y \\ &= V_{m+1} (\beta e_1 - \bar{T}_m y). \end{aligned} \quad (7.16)$$

The norm of the residual vector is therefore

$$\|b - Ax\| = \|V_{m+1} (\beta e_1 - \bar{T}_m y)\|_2. \quad (7.17)$$

If the column-vectors of V_{m+1} were orthonormal, then we would have $\|b - Ax\| = \|\beta e_1 - \bar{T}_m y\|_2$, as in GMRES. Therefore, a least-squares solution could be obtained from the Krylov subspace by minimizing $\|\beta e_1 - \bar{T}_m y\|_2$ over y . In the Lanczos algorithm, the v_i 's are not orthonormal. However, it is still a reasonable idea to minimize the function

$$J(y) \equiv \|\beta e_1 - \bar{T}_m y\|_2$$

over y and compute the corresponding approximate solution $x_0 + V_m y$. The resulting solution is called the *Quasi-Minimal Residual approximation*.

Thus, the Quasi-Minimal Residual (QMR) approximation from the m -th Krylov subspace is obtained as $x_0 + V_m y_m$, where y_m minimizes the function $J(y) = \|\beta e_1 - \bar{T}_m y\|_2$, i.e., just as in GMRES, except that the Arnoldi process is replaced by the Lanczos process. Because of the simple structure of the matrix \bar{T}_m , the following algorithm is obtained, which is adapted from the DQGMRES algorithm (Algorithm 6.13).

ALGORITHM 7.4: QMR

1. Compute $r_0 = b - Ax_0$ and $\gamma_1 := \|r_0\|_2$, $w_1 := v_1 := r_0/\gamma_1$
2. For $m = 1, 2, \dots$, until convergence Do:
3. Compute α_m, δ_{m+1} and v_{m+1}, w_{m+1} as in Algorithm 7.1
4. Update the QR factorization of \bar{T}_m , i.e.,
5. Apply Ω_i , $i = m - 2, m - 1$ to the m -th column of \bar{T}_m
6. Compute the rotation coefficients c_m, s_m by (6.31)
7. Apply rotation Ω_m , to \bar{T}_m and \bar{g}_m , i.e., compute:
8. $\gamma_{m+1} := -s_m \gamma_m$,
9. $\gamma_m := c_m \gamma_m$, and,
10. $\alpha_m := c_m \alpha_m + s_m \delta_{m+1} \left(= \sqrt{\delta_{m+1}^2 + \alpha_m^2} \right)$
11. $p_m = \left(v_m - \sum_{i=m-2}^{m-1} t_{im} p_i \right) / t_{mm}$
12. $x_m = x_{m-1} + \gamma_m p_m$
13. If $|\gamma_{m+1}|$ is small enough then Stop
14. EndDo

The following proposition establishes a result on the residual norm of the solution. It is similar to Proposition 6.9.

PROPOSITION 7.3 *The residual norm of the approximate solution x_m satisfies the relation*

$$\|b - Ax_m\| \leq \|V_{m+1}\|_2 |s_1 s_2 \dots s_m| \|r_0\|_2. \quad (7.18)$$

Proof. According to (7.16) the residual norm is given by

$$b - Ax_m = V_{m+1} [\beta e_1 - \bar{T}_m y_m] \quad (7.19)$$

and using the same notation as in Proposition 6.9, referring to (6.37)

$$\|\beta e_1 - \bar{H}_m y\|_2^2 = |\gamma_{m+1}|^2 + \|g_m - R_m y\|_2^2$$

in which $g_m - R_m y = 0$ by the minimization procedure. In addition, by (6.40) we have

$$\gamma_{m+1} = s_1 \dots s_m \gamma_1.$$

The result follows immediately using (7.19). ■

The following simple upper bound for $\|V_{m+1}\|_2$ can be used to estimate the residual norm:

$$\|V_{m+1}\|_2 \leq \left[\sum_{i=1}^{m+1} \|v_i\|_2^2 \right]^{1/2}.$$

Observe that ideas similar to those used for DQGMRES can be exploited to obtain a better estimate of the residual norm. Also, note that the relation (6.57) for DQGMRES holds. More interestingly, Theorem 6.1 is also valid and it is now restated for QMR.

THEOREM 7.1 *Assume that the Lanczos algorithm does not break down on or before step m and let V_{m+1} be the Lanczos basis obtained at step m . Let r_m^Q and r_m^G be the residual norms obtained after m steps of the QMR and GMRES algorithms, respectively. Then,*

$$\|r_m^Q\|_2 \leq \kappa_2(V_{m+1}) \|r_m^G\|_2.$$

The proof of this theorem is essentially identical with that of Theorem 6.1. Note that V_{m+1} is now known to be of full rank, so we need not make this assumption as in Theorem 6.1.

TRANSPOSE-FREE VARIANTS

7.4

Each step of the Biconjugate Gradient algorithm and QMR requires a matrix-by-vector product with both A and A^T . However, observe that the vectors p_i^* or w_j generated with A^T do not contribute directly to the solution. Instead, they are used only to obtain the scalars needed in the algorithm, e.g., the scalars α_j and β_j for BCG. The question arises

as to whether or not it is possible to bypass the use of the transpose of A and still generate iterates that are related to those of the BCG algorithm. One of the motivations for this question is that, in some applications, A is available only through some approximations and not explicitly. In such situations, the transpose of A is usually not available. A simple example is when a CG-like algorithm is used in the context of Newton's iteration for solving $F(u) = 0$. The linear system that arises at each Newton step can be solved without having to compute the Jacobian $J(u_k)$ at the current iterate u_k explicitly, by using the difference formula

$$J(u_k)v = \frac{F(u_k + \epsilon v) - F(u_k)}{\epsilon}.$$

This allows the action of this Jacobian to be computed on an arbitrary vector v . Unfortunately, there is no similar formula for performing operations with the transpose of $J(u_k)$.

7.4.1 CONJUGATE GRADIENT SQUARED

The Conjugate Gradient Squared algorithm was developed by Sonneveld in 1984 [201], mainly to avoid using the transpose of A in the BCG and to gain faster convergence for roughly the same computational cost. The main idea is based on the following simple observation. In the BCG algorithm, the residual vector at step j can be expressed as

$$r_j = \phi_j(A)r_0 \quad (7.20)$$

where ϕ_j is a certain polynomial of degree j satisfying the constraint $\phi_j(0) = 1$. Similarly, the conjugate-direction polynomial $\pi_j(t)$ is given by

$$p_j = \pi_j(A)r_0, \quad (7.21)$$

in which π_j is a polynomial of degree j . From the algorithm, observe that the directions r_j^* and p_j^* are defined through the same recurrences as r_j and p_j in which A is replaced by A^T and, as a result,

$$r_j^* = \phi_j(A^T)r_0^*, \quad p_j^* = \pi_j(A^T)r_0^*.$$

Also, note that the scalar α_j in BCG is given by

$$\alpha_j = \frac{(\phi_j(A)r_0, \phi_j(A^T)r_0^*)}{(A\pi_j(A)r_0, \pi_j(A^T)r_0^*)} = \frac{(\phi_j^2(A)r_0, r_0^*)}{(A\pi_j^2(A)r_0, r_0^*)}$$

which indicates that if it is possible to get a recursion for the vectors $\phi_j^2(A)r_0$ and $\pi_j^2(A)r_0$, then computing α_j and, similarly, β_j causes no problem. Hence, the idea of seeking an algorithm which would give a sequence of iterates whose residual norms r_j' satisfy

$$r_j' = \phi_j^2(A)r_0. \quad (7.22)$$

The derivation of the method relies on simple algebra only. To establish the desired recurrences for the squared polynomials, start with the recurrences that define ϕ_j and π_j , which are,

$$\phi_{j+1}(t) = \phi_j(t) - \alpha_j t \pi_j(t), \quad (7.23)$$

$$\pi_{j+1}(t) = \phi_{j+1}(t) + \beta_j \pi_j(t). \quad (7.24)$$

If the above relations are squared we get

$$\begin{aligned}\phi_{j+1}^2(t) &= \phi_j^2(t) - 2\alpha_j t \pi_j(t) \phi_j(t) + \alpha_j^2 t^2 \pi_j^2(t), \\ \pi_{j+1}^2(t) &= \phi_{j+1}^2(t) + 2\beta_j \phi_{j+1}(t) \pi_j(t) + \beta_j^2 \pi_j(t)^2.\end{aligned}$$

If it were not for the cross terms $\pi_j(t)\phi_j(t)$ and $\phi_{j+1}(t)\pi_j(t)$ on the right-hand sides, these equations would form an updatable recurrence system. The solution is to introduce one of these two cross terms, namely, $\phi_{j+1}(t)\pi_j(t)$, as a third member of the recurrence. For the other term, i.e., $\pi_j(t)\phi_j(t)$, we can exploit the relation

$$\phi_j(t)\pi_j(t) = \phi_j(t)(\phi_j(t) + \beta_{j-1}\pi_{j-1}(t)) = \phi_j^2(t) + \beta_{j-1}\phi_j(t)\pi_{j-1}(t).$$

By putting these relations together the following recurrences can be derived, in which the variable (t) is omitted where there is no ambiguity:

$$\phi_{j+1}^2 = \phi_j^2 - \alpha_j t (2\phi_j^2 + 2\beta_{j-1}\phi_j\pi_{j-1} - \alpha_j t \pi_j^2) \quad (7.25)$$

$$\phi_{j+1}\pi_j = \phi_j^2 + \beta_{j-1}\phi_j\pi_{j-1} - \alpha_j t \pi_j^2 \quad (7.26)$$

$$\pi_{j+1}^2 = \phi_{j+1}^2 + 2\beta_j\phi_{j+1}\pi_j + \beta_j^2\pi_j^2. \quad (7.27)$$

These recurrences are at the basis of the algorithm. If we define

$$r_j = \phi_j^2(A)r_0, \quad (7.28)$$

$$p_j = \pi_j^2(A)r_0, \quad (7.29)$$

$$q_j = \phi_{j+1}(A)\pi_j(A)r_0, \quad (7.30)$$

then the above recurrences for the polynomials translate into

$$r_{j+1} = r_j - \alpha_j A (2r_j + 2\beta_{j-1}q_{j-1} - \alpha_j A p_j), \quad (7.31)$$

$$q_j = r_j + \beta_{j-1}q_{j-1} - \alpha_j A p_j, \quad (7.32)$$

$$p_{j+1} = r_{j+1} + 2\beta_j q_j + \beta_j^2 p_j. \quad (7.33)$$

It is convenient to define the auxiliary vector

$$d_j = 2r_j + 2\beta_{j-1}q_{j-1} - \alpha_j A p_j.$$

With this we obtain the following sequence of operations to compute the approximate solution, starting with $r_0 := b - Ax_0$, $p_0 := r_0$, $q_0 := 0$, $\beta_0 := 0$.

- $\alpha_j = (r_j, r_0^*) / (Ap_j, r_0^*)$
- $d_j = 2r_j + 2\beta_{j-1}q_{j-1} - \alpha_j A p_j$
- $q_j = r_j + \beta_{j-1}q_{j-1} - \alpha_j A p_j$
- $x_{j+1} = x_j + \alpha_j d_j$
- $r_{j+1} = r_j - \alpha_j A d_j$
- $\beta_j = (r_{j+1}, r_0^*) / (r_j, r_0^*)$
- $p_{j+1} = r_{j+1} + \beta_j (2q_j + \beta_j p_j)$.

A slight simplification to the algorithm can be made by using the auxiliary vector $u_j = r_j + \beta_{j-1}q_{j-1}$. This definition leads to the relations

$$d_j = u_j + q_j,$$

$$\begin{aligned}q_j &= u_j - \alpha_j A p_j, \\p_{j+1} &= u_{j+1} + \beta_j (q_j + \beta_j p_j),\end{aligned}$$

and as a result the vector d_j is no longer needed. The resulting algorithm is given below.

ALGORITHM 7.5: Conjugate Gradient Squared

1. Compute $r_0 := b - Ax_0$; r_0^* arbitrary.
 2. Set $p_0 := u_0 := r_0$.
 3. For $j = 0, 1, 2, \dots$, until convergence Do:
 4. $\alpha_j = (r_j, r_0^*) / (Ap_j, r_0^*)$
 5. $q_j = u_j - \alpha_j Ap_j$
 6. $x_{j+1} = x_j + \alpha_j (u_j + q_j)$
 7. $r_{j+1} = r_j - \alpha_j A(u_j + q_j)$
 8. $\beta_j = (r_{j+1}, r_0^*) / (r_j, r_0^*)$
 9. $u_{j+1} = r_{j+1} + \beta_j q_j$
 10. $p_{j+1} = u_{j+1} + \beta_j (q_j + \beta_j p_j)$
 11. EndDo
-

Observe that there are no matrix-by-vector products with the transpose of A . Instead, two matrix-by-vector products with the matrix A are now performed at each step. In general, one should expect the resulting algorithm to converge twice as fast as BCG. Therefore, what has essentially been accomplished is to replace the matrix-by-vector products with A^T by more useful work.

The Conjugate Gradient Squared algorithm works quite well in many cases. However, one difficulty is that, since the polynomials are squared, rounding errors tend to be more damaging than in the standard BCG algorithm. In particular, very high variations of the residual vectors often cause the residual norms computed from the result of line 7 of the above algorithm to become inaccurate.

7.4.2 BICGSTAB

The CGS algorithm is based on squaring the residual polynomial, and, in cases of irregular convergence, this may lead to substantial build-up of rounding errors, or possibly even overflow. The Biconjugate Gradient Stabilized (BICGSTAB) algorithm is a variation of CGS which was developed to remedy this difficulty. Instead of seeking a method which delivers a residual vector of the form r_j^l defined by (7.22), BICGSTAB produces iterates whose residual vectors are of the form

$$r_j^l = \psi_j(A) \phi_j(A) r_0, \quad (7.34)$$

in which, as before, $\phi_j(t)$ is the residual polynomial associated with the BCG algorithm and $\psi_j(t)$ is a new polynomial which is defined recursively at each step with the goal of “stabilizing” or “smoothing” the convergence behavior of the original algorithm. Specifically, $\psi_j(t)$ is defined by the simple recurrence,

$$\psi_{j+1}(t) = (1 - \omega_j t) \psi_j(t) \quad (7.35)$$

in which the scalar ω_j is to be determined. The derivation of the appropriate recurrence relations is similar to that of CGS. Ignoring the scalar coefficients at first, we start with a relation for the residual polynomial $\psi_{j+1}\phi_{j+1}$. We immediately obtain

$$\psi_{j+1}\phi_{j+1} = (1 - \omega_j t)\psi_j(t)\phi_{j+1} \quad (7.36)$$

$$= (1 - \omega_j t) (\psi_j\phi_j - \alpha_j t\psi_j\pi_j) \quad (7.37)$$

which is updatable provided a recurrence relation is found for the products $\psi_j\pi_j$. For this, write

$$\psi_j\pi_j = \psi_j(\phi_j + \beta_{j-1}\pi_{j-1}) \quad (7.38)$$

$$= \psi_j\phi_j + \beta_{j-1}(1 - \omega_{j-1}t)\psi_{j-1}\pi_{j-1}. \quad (7.39)$$

Define,

$$r_j = \phi_j(A)\psi_j(A)r_0,$$

$$p_j = \psi_j(A)\pi_j(A)r_0.$$

According to the above formulas, these vectors can be updated from a double recurrence provided the scalars α_j and β_j were computable. This recurrence is

$$r_{j+1} = (I - \omega_j A)(r_j - \alpha_j A p_j) \quad (7.40)$$

$$p_{j+1} = r_{j+1} + \beta_j(I - \omega_j A)p_j.$$

Consider now the computation of the scalars needed in the recurrence. According to the original BCG algorithm, $\beta_j = \rho_{j+1}/\rho_j$ with

$$\rho_j = (\phi_j(A)r_0, \phi_j(A^T)r_0^*) = (\phi_j(A)^2 r_0, r_0^*)$$

Unfortunately, ρ_j is not computable from these formulas because none of the vectors $\phi_j(A)r_0$, $\phi_j(A^T)r_0^*$ or $\phi_j(A)^2 r_0$ is available. However, ρ_j can be related to the scalar

$$\tilde{\rho}_j = (\phi_j(A)r_0, \psi_j(A^T)r_0^*)$$

which is computable via

$$\tilde{\rho}_j = (\phi_j(A)r_0, \psi_j(A^T)r_0^*) = (\psi_j(A)\phi_j(A)r_0, r_0^*) = (r_j, r_0^*).$$

To relate the two scalars ρ_j and $\tilde{\rho}_j$, expand $\psi_j(A^T)r_0^*$ explicitly in the power basis, to obtain

$$\tilde{\rho}_j = \left(\phi_j(A)r_0, \eta_1^{(j)}(A^T)^j r_0^* + \eta_2^{(j)}(A^T)^{j-1} r_0^* + \dots \right).$$

Since $\phi_j(A)r_0$ is orthogonal to all vectors $(A^T)^k r_0^*$, with $k < j$, only the leading power is relevant in the expansion on the right side of the above inner product. In particular, if $\gamma_1^{(j)}$ is the leading coefficient for the polynomial $\phi_j(t)$, then

$$\tilde{\rho}_j = \left(\phi_j(A)r_0, \frac{\eta_1^{(j)}}{\gamma_1^{(j)}} \phi_j(A^T)r_0^* \right) = \frac{\eta_1^{(j)}}{\gamma_1^{(j)}} \rho_j.$$

When examining the recurrence relations for ϕ_{j+1} and ψ_{j+1} , leading coefficients for these polynomials are found to satisfy the relations

$$\eta_1^{(j+1)} = -\omega_j \eta_1^{(j)}, \quad \gamma_1^{(j+1)} = -\alpha_j \gamma_1^{(j)},$$

and as a result

$$\frac{\tilde{\rho}_{j+1}}{\tilde{\rho}_j} = \frac{\omega_j}{\alpha_j} \frac{\rho_{j+1}}{\rho_j}$$

which yields the following relation for β_j :

$$\beta_j = \frac{\tilde{\rho}_{j+1}}{\tilde{\rho}_j} \times \frac{\alpha_j}{\omega_j}. \quad (7.41)$$

Similarly, a simple recurrence formula for α_j can be derived. By definition,

$$\alpha_j = \frac{(\phi_j(A)r_0, \phi_j(A^T)r_0^*)}{(A\pi_j(A)r_0, \pi_j(A^T)r_0^*)}$$

and as in the previous case, the polynomials in the right sides of the inner products in both the numerator and denominator can be replaced by their leading terms. However, in this case the leading coefficients for $\phi_j(A^T)r_0^*$ and $\pi_j(A^T)r_0^*$ are identical, and therefore,

$$\begin{aligned} \alpha_j &= \frac{(\phi_j(A)r_0, \phi_j(A^T)r_0^*)}{(A\pi_j(A)r_0, \phi_j(A^T)r_0^*)} \\ &= \frac{(\phi_j(A)r_0, \psi_j(A^T)r_0^*)}{(A\pi_j(A)r_0, \psi_j(A^T)r_0^*)} \\ &= \frac{(\psi_j(A)\phi_j(A)r_0, r_0^*)}{(A\psi_j(A)\pi_j(A)r_0, r_0^*)}. \end{aligned}$$

Since $p_j = \psi_j(A)\pi_j(A)r_0$, this yields,

$$\alpha_j = \frac{\tilde{\rho}_j}{(Ap_j, r_0^*)}. \quad (7.42)$$

Next, the parameter ω_j must be defined. This can be thought of as an additional free parameter. One of the simplest choices, and perhaps the most natural, is to select ω_j to achieve a steepest descent step in the residual direction obtained before multiplying the residual vector by $(I - \omega_j A)$ in (7.40). In other words, ω_j is chosen to minimize the 2-norm of the vector $(I - \omega_j A)\psi_j(A)\phi_{j+1}(A)r_0$. Equation (7.40) can be rewritten as

$$r_{j+1} = (I - \omega_j A)s_j$$

in which

$$s_j \equiv r_j - \alpha_j Ap_j.$$

Then the optimal value for ω_j is given by

$$\omega_j = \frac{(As_j, s_j)}{(As_j, As_j)}. \quad (7.43)$$

Finally, a formula is needed to update the approximate solution x_{j+1} from x_j . Equation (7.40) can be rewritten as

$$r_{j+1} = s_j - \omega_j As_j = r_j - \alpha_j Ap_j - \omega_j As_j$$

which yields

$$x_{j+1} = x_j + \alpha_j p_j + \omega_j s_j.$$

After putting these relations together, we obtain the final form of the BICGSTAB algorithm, due to van der Vorst [210].

ALGORITHM 7.6: BICGSTAB

1. Compute $r_0 := b - Ax_0$; r_0^* arbitrary;
 2. $p_0 := r_0$.
 3. For $j = 0, 1, \dots$, until convergence Do:
 4. $\alpha_j := (r_j, r_0^*) / (Ap_j, r_0^*)$
 5. $s_j := r_j - \alpha_j Ap_j$
 6. $\omega_j := (As_j, s_j) / (As_j, As_j)$
 7. $x_{j+1} := x_j + \alpha_j p_j + \omega_j s_j$
 8. $r_{j+1} := s_j - \omega_j As_j$
 9. $\beta_j := \frac{(r_{j+1}, r_0^*)}{(r_j, r_0^*)} \times \frac{\alpha_j}{\omega_j}$
 10. $p_{j+1} := r_{j+1} + \beta_j(p_j - \omega_j Ap_j)$
 11. EndDo
-

Example 7.2 Table 7.2 shows the results of applying the BICGSTAB algorithm with no preconditioning to three of the test problems described in Section 3.7.

Matrix	Iters	Kflops	Residual	Error
F2DA	96	2048	0.14E-02	0.77E-04
F3D	64	6407	0.49E-03	0.17E-03
ORS	208	5222	0.22E+00	0.68E-04

Table 7.2 A test run of BICGSTAB with no preconditioning.

See Example 6.1 for the meaning of the column headers in the table. The number of matrix-by-vector multiplications required to converge is larger than with BCG. Thus, using the number of matrix-by-vector products as a criterion, BCG is more expensive than BICGSTAB in all three examples. For problem 3, the number of steps for BCG exceeds the limit of 300. If the number of steps is used as a criterion, then the two methods come very close for the second problem [61 steps for BCG versus 64 for BICGSTAB]. However, BCG is slightly faster for Problem 1. Observe also that the total number of operations favors BICGSTAB. This illustrates the main weakness of BCG as well as QMR, namely, the matrix-by-vector products with the transpose are essentially wasted unless a dual system with A^T must be solved simultaneously.

7.4.3 TRANSPOSE-FREE QMR (TFQMR)

The Transpose-Free QMR algorithm of Freund [95] is derived from the CGS algorithm. Observe that x_j can be updated in two half-steps in line 6 of Algorithm 7.5, namely, $x_{j+\frac{1}{2}} = x_j + \alpha_j u_j$ and $x_{j+1} = x_{j+\frac{1}{2}} + \alpha_j q_j$. This is only natural since the actual update from one iterate to the next involves two matrix-by-vector multiplications, i.e., the

degree of the residual polynomial is increased by two. In order to avoid indices that are multiples of $\frac{1}{2}$, it is convenient when describing TFQMR to double all subscripts in the CGS algorithm. With this change of notation, the main steps of the Algorithm 7.5 (CGS) become

$$\alpha_{2j} = (r_{2j}, r_0^*) / (Ap_{2j}, r_0^*) \quad (7.44)$$

$$q_{2j} = u_{2j} - \alpha_{2j}Ap_{2j} \quad (7.45)$$

$$x_{2j+2} = x_{2j} + \alpha_{2j}(u_{2j} + q_{2j}) \quad (7.46)$$

$$r_{2j+2} = r_{2j} - \alpha_{2j}A(u_{2j} + q_{2j}) \quad (7.47)$$

$$\beta_{2j} = (r_{2j+2}, r_0^*) / (r_{2j}, r_0^*) \quad (7.48)$$

$$u_{2j+2} = r_{2j+2} + \beta_{2j}q_{2j} \quad (7.49)$$

$$p_{2j+2} = u_{2j+2} + \beta_{2j}(q_{2j} + \beta_{2j}p_{2j}). \quad (7.50)$$

The initialization is identical with that of Algorithm 7.5. The update of the approximate solution in (7.46) can now be split into the following two half-steps:

$$x_{2j+1} = x_{2j} + \alpha_{2j}u_{2j} \quad (7.51)$$

$$x_{2j+2} = x_{2j+1} + \alpha_{2j}q_{2j}. \quad (7.52)$$

This can be simplified by defining the vectors u_m for odd m as $u_{2j+1} = q_{2j}$. Similarly, the sequence of α_m is defined for odd values of m as $\alpha_{2j+1} = \alpha_{2j}$. In summary,

$$\text{for } m \text{ odd define: } \begin{cases} u_m & \equiv & q_{m-1} \\ \alpha_m & \equiv & \alpha_{m-1} \end{cases} . \quad (7.53)$$

With these definitions, the relations (7.51–7.52) are translated into the single equation

$$x_m = x_{m-1} + \alpha_{m-1}u_{m-1},$$

which is valid whether m is even or odd. The intermediate iterates x_m , with m odd, which are now defined do not exist in the original CGS algorithm. For even values of m the sequence x_m represents the original sequence or iterates from the CGS algorithm. It is convenient to introduce the $N \times m$ matrix,

$$U_m = [u_0, \dots, u_{m-1}]$$

and the m -dimensional vector

$$z_m = (\alpha_0, \alpha_1, \dots, \alpha_{m-1})^T.$$

The general iterate x_m satisfies the relation

$$x_m = x_0 + U_m z_m \quad (7.54)$$

$$= x_{m-1} + \alpha_{m-1}u_{m-1}. \quad (7.55)$$

From the above equation, it is clear that the residual vectors r_m are related to the u -vectors by the relations

$$r_m = r_0 - AU_m z_m \quad (7.56)$$

$$= r_{m-1} - \alpha_{m-1}Au_{m-1}. \quad (7.57)$$

Next, a relation similar to the relation (6.5) seen for FOM and GMRES will be ex-

tracted using the matrix AU_m . As a result of (7.57), the following relation holds:

$$Au_i = \frac{1}{\alpha_i} (r_i - r_{i+1}).$$

Translated in matrix form, this relation becomes

$$AU_m = R_{m+1}\bar{B}_m \quad (7.58)$$

where

$$R_k = [r_0, r_1, \dots, r_{k-1}] \quad (7.59)$$

and where \bar{B}_m is the $(m+1) \times m$ matrix,

$$\bar{B}_m = \begin{pmatrix} 1 & 0 & \dots & \dots & 0 \\ -1 & 1 & & & \vdots \\ 0 & -1 & 1 & \dots & \\ \vdots & & \ddots & \ddots & \vdots \\ \vdots & & & -1 & 1 \\ 0 & \dots & & & -1 \end{pmatrix} \times \text{diag} \left\{ \frac{1}{\alpha_0}, \frac{1}{\alpha_1}, \dots, \frac{1}{\alpha_{m-1}} \right\}. \quad (7.60)$$

The columns of R_{m+1} can be rescaled, for example, to make each of them have a 2-norm equal to one, by multiplying R_{m+1} to the right by a diagonal matrix. Let this diagonal matrix be the inverse of the matrix

$$\Delta_{m+1} = \text{diag} [\delta_0, \delta_1, \dots, \delta_m].$$

Then,

$$AU_m = R_{m+1}\Delta_{m+1}^{-1}\Delta_{m+1}\bar{B}_m. \quad (7.61)$$

With this, equation (7.56) becomes

$$r_m = r_0 - AU_m z_m = R_{m+1} [e_1 - \bar{B}_m z_m] \quad (7.62)$$

$$= R_{m+1}\Delta_{m+1}^{-1} [\delta_0 e_1 - \Delta_{m+1}\bar{B}_m z_m]. \quad (7.63)$$

By analogy with the GMRES algorithm, define

$$\bar{H}_m \equiv \Delta_{m+1}\bar{B}_m.$$

Similarly, define H_m to be the matrix obtained from \bar{H}_m by deleting its last row. It is easy to verify that the CGS iterates x_m (now defined for all integers $m = 0, 1, 2, \dots$) satisfy the same definition as FOM, i.e.,

$$x_m = x_0 + U_m H_m^{-1} (\delta_0 e_1). \quad (7.64)$$

It is also possible to extract a GMRES-like solution from the relations (7.61) and (7.63), similar to DQGMRES. In order to minimize the residual norm over the Krylov subspace, the 2-norm of the right-hand side of (7.63) would have to be minimized, but this is not practical since the columns of $R_{m+1}\Delta_{m+1}^{-1}$ are not orthonormal as in GMRES. However, the 2-norm of $\delta_0 e_1 - \Delta_{m+1}\bar{B}_m z$ can be minimized over z , as was done for the QMR and DQGMRES algorithms.

This defines the TFQMR iterates theoretically. However, it is now necessary to find a formula for expressing the iterates in a progressive way. There are two ways to proceed.

The first follows DQGMRES closely, defining the least-squares solution progressively and exploiting the structure of the matrix R_m to obtain a formula for x_m from x_{m-1} . Because of the special structure of \tilde{H}_m , this is equivalent to using the DQGMRES algorithm with $k = 1$. The second way to proceed exploits Lemma 6.1 seen in the previous chapter. This lemma, which was shown for the FOM/GMRES pair, is also valid for the CGS/TFQMR pair. There is no fundamental difference between the two situations. Thus, the TFQMR iterates satisfy the relation

$$x_m - x_{m-1} = c_m^2 (\tilde{x}_m - x_{m-1}) \quad (7.65)$$

where the tildes are now used to denote the CGS iterate. Setting

$$d_m \equiv \frac{1}{\alpha_{m-1}} (\tilde{x}_m - x_{m-1}) = \frac{1}{c_m^2 \alpha_{m-1}} (x_m - x_{m-1}) \quad (7.66)$$

$$\eta_m \equiv c_m^2 \alpha_{m-1},$$

the above expression for x_m becomes

$$x_m = x_{m-1} + \eta_m d_m. \quad (7.67)$$

Now observe from (7.55) that the CGS iterates \tilde{x}_m satisfy the relation

$$\tilde{x}_m = \tilde{x}_{m-1} + \alpha_{m-1} u_{m-1}. \quad (7.68)$$

From the above equations, a recurrence relation from d_m can be extracted. The definition of d_m and the above relations yield

$$\begin{aligned} d_m &= \frac{1}{\alpha_{m-1}} (\tilde{x}_m - \tilde{x}_{m-1} + \tilde{x}_{m-1} - x_{m-1}) \\ &= u_{m-1} + \frac{1}{\alpha_{m-1}} (\tilde{x}_{m-1} - x_{m-2} - (x_{m-1} - x_{m-2})) \\ &= u_{m-1} + \frac{1 - c_{m-1}^2}{\alpha_{m-1}} (\tilde{x}_{m-1} - x_{m-2}). \end{aligned}$$

Therefore,

$$d_m = u_{m-1} + \frac{(1 - c_{m-1}^2) \eta_{m-1}}{c_{m-1}^2 \alpha_{m-1}} d_{m-1}.$$

The term $(1 - c_{m-1}^2)/c_{m-1}^2$ is the squared tangent of the angle used in the $(m-1)$ -st rotation. This tangent will be denoted by θ_{m-1} , and we have

$$\theta_m = \frac{s_m}{c_m}, \quad c_m^2 = \frac{1}{1 + \theta_m^2}, \quad d_{m+1} = u_m + \frac{\theta_m^2 \eta_m}{\alpha_m} d_m.$$

The angle used in the m -th rotation, or equivalently c_m , can be obtained by examining the

matrix \bar{H}_m :

$$\bar{H}_m = \begin{pmatrix} \delta_0 & 0 & \dots & \dots & 0 \\ -\delta_1 & \delta_1 & & & \vdots \\ 0 & -\delta_2 & \delta_2 & \dots & \\ \vdots & & \ddots & \ddots & \vdots \\ \vdots & & & -\delta_m & \delta_m \\ 0 & \dots & & & -\delta_{m+1} \end{pmatrix} \times \text{diag} \left\{ \frac{1}{\alpha_i} \right\}_{i=0, \dots, m-1}. \quad (7.69)$$

The diagonal matrix in the right-hand side scales the columns of the matrix. It is easy to see that it has no effect on the determination of the rotations. Ignoring this scaling, the above matrix becomes, after j rotations,

$$\begin{pmatrix} \star & \star & & & & & & & & \\ & \star & \star & & & & & & & \\ & & \ddots & \ddots & & & & & & \\ & & & \tau_j & 0 & & & & & \\ & & & -\delta_{j+1} & \delta_{j+1} & & & & & \\ & & & & \ddots & \ddots & & & & \\ & & & & & -\delta_m & \delta_m & & & \\ & & & & & & & -\delta_{m+1} & & \end{pmatrix}.$$

The next rotation is then determined by,

$$s_{j+1} = \frac{-\delta_{j+1}}{\sqrt{\tau_j^2 + \delta_{j+1}^2}}, \quad c_{j+1} = \frac{\tau_j}{\sqrt{\tau_j^2 + \delta_{j+1}^2}}, \quad \theta_{j+1} = \frac{-\delta_{j+1}}{\tau_j}.$$

In addition, after this rotation is applied to the above matrix, the diagonal element δ_{j+1} which is in position $(j+1, j+1)$ is transformed into

$$\tau_{j+1} = \delta_{j+1} \times c_{j+1} = \frac{\tau_j \delta_{j+1}}{\sqrt{\tau_j^2 + \delta_{j+1}^2}} = -\tau_j s_{j+1} = -\tau_j \theta_{j+1} c_{j+1}. \quad (7.70)$$

The above relations enable us to update the direction d_m and the required quantities c_m and η_m . Since only the squares of these scalars are invoked in the update of the direction d_{m+1} , a recurrence for their absolute values is sufficient. This gives the following recurrences which will be used in the algorithm:

$$\begin{aligned} d_{m+1} &= u_m + (\theta_m^2 / \alpha_m) \eta_m d_m \\ \theta_{m+1} &= \delta_{m+1} / \tau_m \\ c_{m+1} &= (1 + \theta_{m+1}^2)^{-\frac{1}{2}} \\ \tau_{m+1} &= \tau_m \theta_{m+1} c_{m+1} \\ \eta_{m+1} &= c_{m+1}^2 \alpha_m. \end{aligned}$$

Before writing down the algorithm, a few relations must be exploited. Since the vectors r_m are no longer the actual residuals in the algorithm, we change the notation to w_m . These residual vectors can be updated by the formula

$$w_m = w_{m-1} - \alpha_{m-1} A u_{m-1}.$$

The vectors Au_i can be used to update the vectors

$$v_{2j} \equiv Ap_{2j}$$

which are needed in the CGS algorithm. Multiplying (7.50) by A results in

$$Ap_{2j} = Au_{2j} + \beta_{2j-2}(Aq_{2j-2} + \beta_j Ap_{2j-2})$$

which, upon substituting the relation

$$q_{2j} = u_{2j+1}$$

translates into

$$v_{2j} = Au_{2j} + \beta_{2j-2}(Au_{2j-1} + \beta_{2j-2}v_{2j-2}).$$

Also, observe that the recurrences in (7.45) and (7.49) for q_{2j} and u_{2j+2} , respectively, become

$$\begin{aligned} u_{2j+1} &= u_{2j} - \alpha_{2j}v_{2j} \\ u_{2j+2} &= w_{2j+2} + \beta_{2j}u_{2j+1}. \end{aligned}$$

The first equation should be used to compute u_{m+1} when m is even, and the second when m is odd. In the following algorithm, the normalization $\delta_m = \|w_m\|_2$, which normalize each column of R_m to have 2-norm unity, is used.

ALGORITHM 7.7: Transpose-Free QMR (TFQMR)

1. Compute $w_0 = u_0 = r_0 = b - Ax_0$, $v_0 = Au_0$, $d_0 = 0$;
2. $\tau_0 = \|r_0\|_2$, $\theta_0 = \eta_0 = 0$.
3. Choose r_0^* such that $\rho_0 \equiv (r_0^*, r_0) \neq 0$.
4. For $m = 0, 1, 2, \dots$, until convergence Do:
 5. If m is even then
 6. $\alpha_{m+1} = \alpha_m = \rho_m / (v_m, r_0^*)$
 7. $u_{m+1} = u_m - \alpha_m v_m$
 8. EndIf
 9. $w_{m+1} = w_m - \alpha_m Au_m$
 10. $d_{m+1} = u_m + (\theta_m^2 / \alpha_m) \eta_m d_m$
 11. $\theta_{m+1} = \|w_{m+1}\|_2 / \tau_m$; $c_{m+1} = (1 + \theta_{m+1}^2)^{-\frac{1}{2}}$
 12. $\tau_{m+1} = \tau_m \theta_{m+1} c_{m+1}$; $\eta_{m+1} = c_{m+1}^2 \alpha_m$
 13. $x_{m+1} = x_m + \eta_{m+1} d_{m+1}$
 14. If m is odd then
 15. $\rho_{m+1} = (r_{m+1}, r_0^*)$; $\beta_{m-1} = \rho_{m+1} / \rho_{m-1}$
 16. $u_{m+1} = w_{m+1} + \beta_{m-1} u_m$
 17. $v_{m+1} = Au_{m+1} + \beta_{m-1} (Au_m + \beta_{m-1} v_{m-1})$
 18. EndIf
 19. EndDo

Notice that the quantities in the odd m loop are only defined for even values of m . The residual norm of the approximate solution x_m is not available from the above algorithm as it is described. However, good estimates can be obtained using similar strategies to

those used for DQGMRES. Referring to GMRES, an interesting observation is that the recurrence (6.40) is identical with the recurrence of the scalars τ_j 's. In addition, these two sequences start with the same values, δ_0 for the τ 's and β for the γ 's. Therefore,

$$\gamma_{m+1} = \tau_m.$$

Recall that γ_{m+1} is the residual for the $(m+1) \times m$ least-squares problem

$$\min_z \|\delta_0 e_1 - \tilde{H}_m z\|_2.$$

Hence, a relation similar to that for DQGMRES holds, namely,

$$\|b - Ax_m\| \leq \sqrt{m+1} \tau_m. \quad (7.71)$$

This provides a readily computable estimate of the residual norm. Another point that should be made is that it is possible to use the scalars s_m, c_m in the recurrence instead of the pair c_m, θ_m , as was done above. In this case, the proper recurrences are

$$\begin{aligned} d_{m+1} &= u_m + (s_m^2 / \alpha_m) \alpha_{m-1} d_m \\ s_{m+1} &= \delta_{m+1} / \sqrt{\tau_m^2 + \delta_{m+1}^2} \\ c_{m+1} &= \tau_m / \sqrt{\tau_m^2 + \delta_{m+1}^2} \\ \tau_{m+1} &= \tau_m s_{m+1} \\ \eta_{m+1} &= c_{m+1}^2 \alpha_m. \end{aligned}$$

Example 7.3 Table 7.3 shows the results when TFQMR algorithm without preconditioning is applied to three of the test problems described in Section 3.7.

Matrix	Iters	Kflops	Residual	Error
F2DA	112	2736	0.46E-04	0.68E-04
F3D	78	8772	0.52E-04	0.61E-03
ORS	252	7107	0.38E-01	0.19E-03

Table 7.3 A test run of TFQMR with no preconditioning.

See Example 6.1 for the meaning of the column headers in the table. The number of steps is slightly higher than that of BICGSTAB. Comparing with BCG, we note that each step of BCG requires two matrix-by-vector products compared with one for TFQMR and BICGSTAB. Thus, using the number of matrix-by-vector products as a criterion, BCG is more expensive than TFQMR in all cases, as is shown in the "Iters" columns. If the number of steps is used as a criterion, then BCG is just slightly better for Problems 1 and 2. A comparison is not possible for Problem 3, since the number of matrix-by-vector products required for convergence exceeds the limit of 300. In general, the number of steps required for convergence is similar for BICGSTAB and TFQMR. A comparison with the methods seen in the previous chapter indicates that in many cases, GMRES will be faster if the problem is well conditioned, resulting in a moderate number of steps required to converge. If many steps (say, in the hundreds) are required, then BICGSTAB and TFQMR may perform better. If memory is not an issue, GMRES or DQGMRES, with a large number of directions, is often the most reliable choice. The issue then is one of trading robustness for

memory usage. In general, a sound strategy is to focus on finding a good preconditioner rather than the best accelerator.

EXERCISES

1. Consider the following modification of the Lanczos algorithm, Algorithm 7.1. We replace line 6 by

$$\hat{w}_{j+1} = A^T w_j - \sum_{i=1}^j h_{ij} w_i$$

where the scalars h_{ij} are arbitrary. Lines 5 and 7 through 10 remain the same but line 4 in which α_j is computed must be changed.

- Show how to modify line 4 to ensure that the vector \hat{v}_{j+1} is orthogonal against the vectors w_i , for $i = 1, \dots, j$.
 - Prove that the vectors v_i 's and the matrix T_m do not depend on the choice of the h_{ij} 's.
 - Consider the simplest possible choice, namely, $h_{ij} \equiv 0$ for all i, j . What are the advantages and potential difficulties with this choice?
2. Assume that the Lanczos algorithm does not break down before step m , i.e., that it is possible to generate v_1, \dots, v_{m+1} . Show that V_{m+1} and W_{m+1} are both of full rank.
3. Develop a modified version of the non-Hermitian Lanczos algorithm that produces a sequence of vectors v_i, w_i such that each v_i is orthogonal to every w_j with $j \neq i$ and $\|v_i\|_2 = \|w_i\|_2 = 1$ for all i . What does the projected problem become?
4. Develop a version of the non-Hermitian Lanczos algorithm that produces a sequence of vectors v_i, w_i which satisfy

$$(v_i, w_j) = \pm \delta_{ij},$$

but such that the matrix T_m is Hermitian tridiagonal. What does the projected problem become in this situation?

5. Using the notation of Section 7.1.2 prove that $q_{j+k}(t) = t^k p_j(t)$ is orthogonal to the polynomials p_1, p_2, \dots, p_{j-k} , assuming that $k \leq j$. Show that if q_{j+k} is orthogonalized against p_1, p_2, \dots, p_{j-k} , the result would be orthogonal to all polynomials of degree $< j+k$. Derive a general Look-Ahead non-Hermitian Lanczos procedure based on this observation.
6. Consider the matrices $V_m = [v_1, \dots, v_m]$ and $W_m = [w_1, \dots, w_m]$ obtained from the Lanczos biorthogonalization algorithm. (a) What are the matrix representations of the (oblique) projector onto $\mathcal{K}_m(A, v_1)$ orthogonal to the subspace $\mathcal{K}_m(A^T, w_1)$, and the projector onto $\mathcal{K}_m(A^T, w_1)$ orthogonally to the subspace $\mathcal{K}_m(A, v_1)$? (b) Express a general condition for the existence of an oblique projector onto K , orthogonal to L . (c) How can this condition be interpreted using the Lanczos vectors and the Lanczos algorithm?
7. Show a three-term recurrence satisfied by the residual vectors r_j of the BCG algorithm. Include the first two iterates to start the recurrence. Similarly, establish a three-term recurrence for the conjugate direction vectors p_j in BCG.

8. Let $\phi_j(t)$ and $\pi_j(t)$ be the residual polynomial and the conjugate direction polynomial, respectively, for the BCG algorithm, as defined in Section 7.4.1. Let $\psi_j(t)$ be any other polynomial sequence which is defined from the recurrence

$$\begin{aligned}\psi_0(t) &= 1, & \psi_1(t) &= (1 - \xi_0 t)\psi_0(t) \\ \psi_{j+1}(t) &= (1 + \eta_j - \xi_j t)\psi_j(t) - \eta_j \psi_{j-1}(t)\end{aligned}$$

- a. Show that the polynomials ψ_j are consistent, i.e., $\psi_j(0) = 1$ for all $j \geq 0$.
b. Show the following relations

$$\begin{aligned}\psi_{j+1}\phi_{j+1} &= \psi_j\phi_{j+1} - \eta_j(\psi_{j-1} - \psi_j)\phi_{j+1} - \xi_j t\psi_j\phi_{j+1} \\ \psi_j\phi_{j+1} &= \psi_j\phi_j - \alpha_j t\psi_j\pi_j \\ (\psi_{j-1} - \psi_j)\phi_{j+1} &= \psi_{j-1}\phi_j - \psi_j\phi_{j+1} - \alpha_j t\psi_{j-1}\pi_j \\ \psi_{j+1}\pi_{j+1} &= \psi_{j+1}\phi_{j+1} - \beta_j\eta_j\psi_{j-1}\pi_j + \beta_j(1 + \eta_j)\psi_j\pi_j - \beta_j\xi_j t\psi_j\pi_j \\ \psi_j\pi_{j+1} &= \psi_j\phi_{j+1} + \beta_j\psi_j\pi_j.\end{aligned}$$

- c. Defining,

$$\begin{aligned}t_j &= \psi_j(A)\phi_{j+1}(A)r_0, & y_j &= (\psi_{j-1}(A) - \psi_j(A))\phi_{j+1}(A)r_0, \\ p_j &= \psi_j(A)\pi_j(A)r_0, & s_j &= \psi_{j-1}(A)\pi_j(A)r_0\end{aligned}$$

show how the recurrence relations of the previous question translate for these vectors.

- d. Find a formula that allows one to update the approximation x_{j+1} from the vectors x_{j-1} , x_j and t_j , p_j , y_j , s_j defined above.
e. Proceeding as in BICGSTAB, find formulas for generating the BCG coefficients α_j and β_j from the vectors defined in the previous question.
9. Prove the expression (7.64) for the CGS approximation defined by (7.54–7.55). Is the relation valid for any choice of scaling Δ_{m+1} ?
10. Prove that the vectors r_j and r_i^* produced by the BCG algorithm are orthogonal to each other when $i \neq j$, while the vectors p_i and p_j^* are A -orthogonal, i.e., $(Ap_j, p_i^*) = 0$ for $i \neq j$.
11. The purpose of this exercise is to develop block variants of the Lanczos algorithm. Consider a two-sided analogue of the Block-Arnoldi algorithm, in its variant of Algorithm 6.23. Formally, the general step that defines the biorthogonalization process, for $j \geq p$, is as follows:

1. Orthogonalize Av_{j-p+1} versus w_1, w_2, \dots, w_j (by subtracting a linear combination of v_1, \dots, v_j from Av_{j-p+1}). Call v the resulting vector.
2. Orthogonalize $A^T w_{j-p+1}$ versus v_1, v_2, \dots, v_j (by subtracting a linear combination of w_1, \dots, w_j from $A^T w_{j-p+1}$). Call w the resulting vector.
3. Normalize the two vectors v and w so that $(v, w) = 1$ to get v_{j+1} and w_{j+1} .

Here, p is the block size and it is assumed that the initial blocks are biorthogonal: $(v_i, w_j) = \delta_{ij}$ for $i, j \leq p$.

- a. Show that Av_{j-p+1} needs only to be orthogonalized against the $2p$ previous w_i 's instead of all of them. Similarly, $A^T w_{j-p+1}$ must be orthogonalized only against the $2p$ previous v_i 's.
b. Write down the algorithm completely. Show the orthogonality relations satisfied by the vectors v_i and w_j . Show also relations similar to (7.3) and (7.4).
c. We now assume that the two sets of vectors v_i and w_j have different block sizes. Call q the block-size for the w 's. Line 2 of the above formal algorithm is changed into:

- 2a. Orthogonalize $A^T w_{j-q+1}$ versus v_1, v_2, \dots, v_j (\dots). Call w the resulting vector.

and the rest remains unchanged. The initial vectors are again biorthogonal: $(v_i, w_j) = \delta_{ij}$ for $i \leq p$ and $j \leq q$. Show that now Av_{j-p+1} needs only to be orthogonalized against the $q + p$ previous w_i 's instead of all of them. Show a similar result for the w_j 's.

- d. Show how a block version of BCG and QMR can be developed based on the algorithm resulting from question (c).

NOTES AND REFERENCES. At the time of this writing there is still much activity devoted to the class of methods covered in this chapter. Two of the starting points in this direction are the papers by Sonneveld [201] and Freund and Nachtigal [97]. The more recent BICGSTAB [210] has been developed to cure some of the numerical problems that plague CGS. There have been a few recent additions and variations to the basic BCG, BICGSTAB, and TFQMR techniques; see [42, 47, 113, 114, 192], among many others. A number of variations have been developed to cope with the breakdown of the underlying Lanczos or BCG algorithm; see, for example, [41, 20, 96, 192, 231]. Finally, block methods have also been developed [5].

Many of the Lanczos-type algorithms developed for solving linear systems are rooted in the theory of orthogonal polynomials and Padé approximation. Lanczos himself certainly used this viewpoint when he wrote his breakthrough papers [140, 142] in the early 1950s. The monogram by Brezinski [38] gives an excellent coverage of the intimate relations between approximation theory and the Lanczos-type algorithms. Freund [94] establishes these relations for quasi-minimal residual methods. A few optimality properties for the class of methods presented in this chapter can be proved using a variable metric, i.e., an inner product which is different at each step [21]. A recent survey by Weiss [224] presents a framework for Krylov subspace methods explaining some of these optimality properties and the interrelationships between Krylov subspace methods. Several authors discuss a class of techniques known as residual smoothing; see for example [191, 234, 224, 40]. These techniques can be applied to any iterative sequence x_k to build a new sequence of iterates y_k by combining y_{k-1} with the difference $x_k - y_{k-1}$. A remarkable result shown by Zhou and Walker [234] is that the iterates of the QMR algorithm can be obtained from those of the BCG as a particular case of residual smoothing.

A number of projection-type methods on Krylov subspaces, other than those seen in this chapter and the previous one are described in [1]. The group of rank- k update methods discussed by Eirola and Nevanlinna [79] and Deuffhard et al. [70] is closely related to Krylov subspace methods. In fact, GMRES can be viewed as a particular example of these methods. Also of interest and not covered in this book are the *vector extrapolation* techniques which are discussed, for example, in the books Brezinski [38], Brezinski and Radivo Zaglia [39] and the articles [199] and [126]. Connections between these methods and Krylov subspace methods, have been uncovered, and are discussed by Brezinski [38] and Sidi [195]. ■

METHODS RELATED TO THE NORMAL EQUATIONS

There are a number of techniques for converting a non-symmetric linear system into a symmetric one. One such technique solves the equivalent linear system $A^T A x = A^T b$, called the normal equations. Often, this approach is avoided in practice because the coefficient matrix $A^T A$ is much worse conditioned than A . However, the normal equations approach may be adequate in some situations. Indeed, there are even applications in which it is preferred to the usual Krylov subspace techniques. This chapter covers iterative methods which are either directly or implicitly related to the normal equations.

THE NORMAL EQUATIONS

8.1

In order to solve the linear system $Ax = b$ when A is nonsymmetric, we can solve the equivalent system

$$A^T A x = A^T b \quad (8.1)$$

which is Symmetric Positive Definite. This system is known as the system of the *normal equations* associated with the least-squares problem,

$$\text{minimize } \|b - Ax\|_2. \quad (8.2)$$

Note that (8.1) is typically used to solve the least-squares problem (8.2) for *over-determined* systems, i.e., when A is a rectangular matrix of size $n \times m$, $m < n$.

A similar well known alternative sets $x = A^T u$ and solves the following equation for u :

$$A A^T u = b. \quad (8.3)$$

Once the solution u is computed, the original unknown x could be obtained by multiplying u by A^T . However, most of the algorithms we will see do not invoke the u variable explicitly and work with the original variable x instead. The above system of equations can be used to solve *under-determined* systems, i.e., those systems involving rectangular matrices of size $n \times m$, with $n < m$. It is related to (8.1) in the following way. Assume that $n \leq m$ and that A has full rank. Let x_* be any solution to the underdetermined system $Ax = b$. Then (8.3) represents the normal equations for the least-squares problem,

$$\text{minimize } \|x_* - A^T u\|_2. \quad (8.4)$$

Since by definition $A^T u = x$, then (8.4) will find the solution vector x that is closest to x_* in the 2-norm sense. What is interesting is that when $n < m$ there are infinitely many solutions x_* to the system $Ax = b$, but the minimizer u of (8.4) does not depend on the particular x_* used.

The system (8.1) and methods derived from it are often labeled with NR (N for “Normal” and R for “Residual”) while (8.3) and related techniques are labeled with NE (N for “Normal” and E for “Error”). If A is square and nonsingular, the coefficient matrices of these systems are both Symmetric Positive Definite, and the simpler methods for symmetric problems, such as the Conjugate Gradient algorithm, can be applied. Thus, CGNE denotes the Conjugate Gradient method applied to the system (8.3) and CGNR the Conjugate Gradient method applied to (8.1).

There are several alternative ways to formulate symmetric linear systems having the same solution as the original system. For instance, the symmetric linear system

$$\begin{pmatrix} I & A \\ A^T & O \end{pmatrix} \begin{pmatrix} r \\ x \end{pmatrix} = \begin{pmatrix} b \\ 0 \end{pmatrix} \quad (8.5)$$

with $r = b - Ax$, arises from the standard necessary conditions satisfied by the solution of the constrained optimization problem,

$$\text{minimize } \frac{1}{2} \|r - b\|_2^2 \quad (8.6)$$

$$\text{subject to } A^T r = 0. \quad (8.7)$$

The solution x to (8.5) is the vector of Lagrange multipliers for the above problem.

Another equivalent symmetric system is of the form

$$\begin{pmatrix} O & A \\ A^T & O \end{pmatrix} \begin{pmatrix} Ax \\ x \end{pmatrix} = \begin{pmatrix} b \\ A^T b \end{pmatrix}.$$

The eigenvalues of the coefficient matrix for this system are $\pm\sigma_i$, where σ_i is an arbitrary singular value of A . Indefinite systems of this sort are not easier to solve than the original nonsymmetric system in general. Although not obvious immediately, this approach is similar in nature to the approach (8.1) and the corresponding Conjugate Gradient iterations applied to them should behave similarly.

A general consensus is that solving the normal equations can be an inefficient approach in the case when A is poorly conditioned. Indeed, the 2-norm condition number of $A^T A$ is given by

$$\text{Cond}_2(A^T A) = \|A^T A\|_2 \|(A^T A)^{-1}\|_2.$$

Now observe that $\|A^T A\|_2 = \sigma_{\max}^2(A)$ where $\sigma_{\max}(A)$ is the largest singular value of A

which, incidentally, is also equal to the 2-norm of A . Thus, using a similar argument for the inverse $(A^T A)^{-1}$ yields

$$\text{Cond}_2(A^T A) = \|A\|_2^2 \|A^{-1}\|_2^2 = \text{Cond}_2^2(A). \quad (8.8)$$

The 2-norm condition number for $A^T A$ is exactly the square of the condition number of A , which could cause difficulties. For example, if originally $\text{Cond}_2(A) = 10^8$, then an iterative method may be able to perform reasonably well. However, a condition number of 10^{16} can be much more difficult to handle by a standard iterative method. That is because any progress made in one step of the iterative procedure may be annihilated by the noise due to numerical errors. On the other hand, if the original matrix has a good 2-norm condition number, then the normal equation approach should not cause any serious difficulties. In the extreme case when A is unitary, i.e., when $A^H A = I$, then the normal equations are clearly the best approach (the Conjugate Gradient method will converge in zero step!).

ROW PROJECTION METHODS

8.2

When implementing a basic relaxation scheme, such as Jacobi or SOR, to solve the linear system

$$A^T A x = A^T b, \quad (8.9)$$

or

$$A A^T u = b, \quad (8.10)$$

it is possible to exploit the fact that the matrices $A^T A$ or $A A^T$ need not be formed explicitly. As will be seen, only a row or a column of A at a time is needed at a given relaxation step. These methods are known as *row projection methods* since they are indeed projection methods on rows of A or A^T . Block row projection methods can also be defined similarly.

8.2.1 GAUSS-SEIDEL ON THE NORMAL EQUATIONS

It was stated above that in order to use relaxation schemes on the normal equations, only access to one column of A at a time is needed for (8.9) and one row at a time for (8.10). This is now explained for (8.10) first. Starting from an approximation to the solution of (8.10), a basic relaxation-based iterative procedure modifies its components in a certain order using a succession of relaxation steps of the simple form

$$u_{new} = u + \delta_i e_i \quad (8.11)$$

where e_i is the i -th column of the identity matrix. The scalar δ_i is chosen so that the i -th component of the residual vector for (8.10) becomes zero. Therefore,

$$(b - A A^T (u + \delta_i e_i), e_i) = 0 \quad (8.12)$$

which, setting $r = b - AA^T u$, yields,

$$\delta_i = \frac{(r, e_i)}{\|A^T e_i\|_2^2}. \quad (8.13)$$

Denote by β_i the i -th component of b . Then a basic relaxation step consists of taking

$$\delta_i = \frac{\beta_i - (A^T u, A^T e_i)}{\|A^T e_i\|_2^2}. \quad (8.14)$$

Also, (8.11) can be rewritten in terms of x -variables as follows:

$$x_{new} = x + \delta_i A^T e_i. \quad (8.15)$$

The auxiliary variable u has now been removed from the scene and is replaced by the original variable $x = A^T u$.

Consider the implementation of a forward Gauss-Seidel sweep based on (8.15) and (8.13) for a general sparse matrix. The evaluation of δ_i from (8.13) requires the inner product of the current approximation $x = A^T u$ with $A^T e_i$, the i -th row of A . This inner product is inexpensive to compute because $A^T e_i$ is usually sparse. If an acceleration parameter ω is used, we only need to change δ_i into $\omega \delta_i$. Therefore, a forward SOR sweep would be as follows.

ALGORITHM 8.1: Forward NE-SOR Sweep

1. Choose an initial x .
 2. For $i = 1, 2, \dots, n$ Do:
 3. $\delta_i = \omega \frac{\beta_i - (A^T e_i, x)}{\|A^T e_i\|_2^2}$
 4. $x := x + \delta_i A^T e_i$
 5. EndDo
-

Note that $A^T e_i$ is a vector equal to the transpose of the i -th row of A . All that is needed is the row data structure for A to implement the above algorithm. Denoting by nz_i the number of nonzero elements in the i -th row of A , then each step of the above sweep requires $2nz_i + 2$ operations in line 3, and another $2nz_i$ operations in line 4, bringing the total to $4nz_i + 2$. The total for a whole sweep becomes $4nz + 2n$ operations, where nz represents the total number of nonzero elements of A . Twice as many operations are required for the Symmetric Gauss-Seidel or the SSOR iteration. Storage consists of the right-hand side, the vector x , and possibly an additional vector to store the 2-norms of the rows of A . A better alternative would be to rescale each row by its 2-norm at the start.

Similarly, a Gauss-Seidel sweep for (8.9) would consist of a succession of steps of the form

$$x_{new} = x + \delta_i e_i. \quad (8.16)$$

Again, the scalar δ_i is to be selected so that the i -th component of the residual vector for (8.9) becomes zero, which yields

$$(A^T b - A^T A(x + \delta_i e_i), e_i) = 0. \quad (8.17)$$

With $r \equiv b - Ax$, this becomes $(A^T(r - \delta_i Ae_i), e_i) = 0$, which yields

$$\delta_i = \frac{(r, Ae_i)}{\|Ae_i\|_2^2}. \quad (8.18)$$

Then the following algorithm is obtained.

ALGORITHM 8.2: Forward NR-SOR Sweep

1. Choose an initial x , compute $r := b - Ax$.
 2. For $i = 1, 2, \dots, n$ Do:
 3. $\delta_i = \omega \frac{(r, Ae_i)}{\|Ae_i\|_2^2}$
 4. $x := x + \delta_i e_i$
 5. $r := r - \delta_i Ae_i$
 6. EndDo
-

In contrast with Algorithm 8.1, the column data structure of A is now needed for the implementation instead of its row data structure. Here, the right-hand side b can be overwritten by the residual vector r , so the storage requirement is essentially the same as in the previous case. In the NE version, the scalar $\beta_i - (x, a_i)$ is just the i -th component of the current residual vector $r = b - Ax$. As a result, stopping criteria can be built for both algorithms based on either the residual vector or the variation in the solution. Note that the matrices AA^T and $A^T A$ can be dense or generally much less sparse than A , yet the cost of the above implementations depends only on the nonzero structure of A . This is a significant advantage of relaxation-type preconditioners over incomplete factorization preconditioners when using Conjugate Gradient methods to solve the normal equations.

One question remains concerning the acceleration of the above relaxation schemes by under- or over-relaxation. If the usual acceleration parameter ω is introduced, then we only have to multiply the scalars δ_i in the previous algorithms by ω . One serious difficulty here is to determine the optimal relaxation factor. If nothing in particular is known about the matrix AA^T , then the method will converge for any ω lying strictly between 0 and 2, as was seen in Chapter 4, because the matrix is positive definite. Moreover, another unanswered question is how convergence can be affected by various reorderings of the rows. For general sparse matrices, the answer is not known.

8.2.2 CIMMINO'S METHOD

In a Jacobi iteration for the system (8.9), the components of the new iterate satisfy the following condition:

$$(A^T b - A^T A(x + \delta_i e_i), e_i) = 0. \quad (8.19)$$

This yields

$$(b - A(x + \delta_i e_i), Ae_i) = 0 \quad \text{or} \quad (r - \delta_i Ae_i, Ae_i) = 0$$

in which r is the old residual $b - Ax$. As a result, the i -component of the new iterate x_{new} is given by

$$x_{new,i} = x_i + \delta_i e_i, \quad (8.20)$$

$$\delta_i = \frac{(r, Ae_i)}{\|Ae_i\|_2^2}. \quad (8.21)$$

Here, be aware that these equations do not result in the same approximation as that produced by Algorithm 8.2, even though the modifications are given by the same formula. Indeed, the vector x is not updated after each step and therefore the scalars δ_i are different for the two algorithms. This algorithm is usually described with an acceleration parameter ω , i.e., all δ_i 's are multiplied uniformly by a certain ω . If d denotes the vector with coordinates $\delta_i, i = 1, \dots, n$, the following algorithm results.

ALGORITHM 8.3: Cimmino-NR

1. Choose initial guess x_0 . Set $x = x_0, r = b - Ax_0$
 2. Until convergence Do:
 3. For $i = 1, \dots, n$ Do:
 4. $\delta_i = \omega \frac{(r, Ae_i)}{\|Ae_i\|_2^2}$
 5. EndDo
 6. $x := x + d$ where $d = \sum_{i=1}^n \delta_i e_i$
 7. $r := r - Ad$
 8. EndDo
-

Notice that all the coordinates will use the same residual vector r to compute the updates δ_i . When $\omega = 1$, each instance of the above formulas is mathematically equivalent to performing a projection step for solving $Ax = b$ with $\mathcal{K} = \text{span}\{e_i\}$, and $\mathcal{L} = AK$. It is also mathematically equivalent to performing an orthogonal projection step for solving $A^T Ax = A^T b$ with $\mathcal{K} = \text{span}\{e_i\}$.

It is interesting to note that when each column Ae_i is normalized by its 2-norm, i.e., if $\|Ae_i\|_2 = 1, i = 1, \dots, n$, then $\delta_i = \omega(r, Ae_i) = \omega(A^T r, e_i)$. In this situation,

$$d = \omega A^T r = \omega A^T (b - Ax)$$

and the main loop of the algorithm takes the vector form

$$\begin{aligned} d &:= \omega A^T r \\ x &:= x + d \\ r &:= r - Ad. \end{aligned}$$

Each iteration is therefore equivalent to a step of the form

$$x_{new} = x + \omega (A^T b - A^T Ax)$$

which is nothing but the Richardson iteration applied to the normal equations (8.1). In particular, as was seen in 4.1, convergence is guaranteed for any ω which satisfies,

$$0 < \omega < \frac{2}{\lambda_{max}} \quad (8.22)$$

where λ_{max} is the largest eigenvalue of $A^T A$. In addition, the best acceleration parameter is given by

$$\omega_{opt} = \frac{2}{\lambda_{min} + \lambda_{max}}$$

in which, similarly, λ_{min} is the smallest eigenvalue of $A^T A$. If the columns are not normalized by their 2-norms, then the procedure is equivalent to a preconditioned Richardson iteration with diagonal preconditioning. The theory regarding convergence is similar but involves the preconditioned matrix or, equivalently, the matrix A' obtained from A by normalizing its columns.

The algorithm can be expressed in terms of projectors. Observe that the new residual satisfies

$$r_{new} = r - \sum_{i=1}^n \omega \frac{(r, Ae_i)}{\|Ae_i\|_2^2} Ae_i. \quad (8.23)$$

Each of the operators

$$P_i : r \longrightarrow \frac{(r, Ae_i)}{\|Ae_i\|_2^2} Ae_i \equiv P_i r \quad (8.24)$$

is an orthogonal projector onto Ae_i , the i -th column of A . Hence, we can write

$$r_{new} = \left(I - \omega \sum_{i=1}^n P_i \right) r. \quad (8.25)$$

There are two important variations to the above scheme. First, because the point Jacobi iteration can be very slow, it may be preferable to work with sets of vectors instead. Let $\pi_1, \pi_2, \dots, \pi_p$ be a partition of the set $\{1, 2, \dots, n\}$ and, for each π_j , let E_j be the matrix obtained by extracting the columns of the identity matrix whose indices belong to π_j . Going back to the projection framework, define $A_i = AE_i$. If an orthogonal projection method is used onto E_j to solve (8.1), then the new iterate is given by

$$x_{new} = x + \omega \sum_i^p E_i d_i \quad (8.26)$$

$$d_i = (E_i^T A^T A E_i)^{-1} E_i^T A^T r = (A_i^T A_i)^{-1} A_i^T r. \quad (8.27)$$

Each individual block-component d_i can be obtained by solving a least-squares problem

$$\min_d \|r - A_i d\|_2.$$

An interpretation of this indicates that each individual substep attempts to reduce the residual as much as possible by taking linear combinations from specific columns of A_i . Similar to the scalar iteration, we also have

$$r_{new} = \left(I - \omega \sum_{i=1}^n P_i \right) r$$

where P_i now represents an orthogonal projector onto the span of A_i .

Note that A_1, A_2, \dots, A_p is a partition of the column-set $\{Ae_i\}_{i=1, \dots, n}$ and this partition can be arbitrary. Another remark is that the original Cimmino method was formulated

for rows instead of columns, i.e., it was based on (8.1) instead of (8.3). The alternative algorithm based on columns rather than rows is easy to derive.

CONJUGATE GRADIENT AND NORMAL EQUATIONS

8.3

A popular combination to solve nonsymmetric linear systems applies the Conjugate Gradient algorithm to solve either (8.1) or (8.3). As is shown next, the resulting algorithms can be rearranged because of the particular nature of the coefficient matrices.

8.3.1 CGNR

We begin with the Conjugate Gradient algorithm applied to (8.1). Applying CG directly to the system and denoting by z_i the residual vector at step i (instead of r_i) results in the following sequence of operations:

- $\alpha_j := (z_j, z_j) / (A^T A p_j, p_j) = (z_j, z_j) / (A p_j, A p_j)$
- $x_{j+1} := x_j + \alpha_j p_j$
- $z_{j+1} := z_j - \alpha_j A^T A p_j$
- $\beta_j := (z_{j+1}, z_{j+1}) / (z_j, z_j)$
- $p_{j+1} := z_{j+1} + \beta_j p_j$.

If the original residual $r_i = b - Ax_i$ must be available at every step, we may compute the residual z_{i+1} in two parts: $r_{j+1} := r_j - \alpha_j A p_j$ and then $z_{i+1} = A^T r_{i+1}$ which is the residual for the normal equations (8.1). It is also convenient to introduce the vector $w_i = A p_i$. With these definitions, the algorithm can be cast in the following form.

ALGORITHM 8.4: CGNR

1. Compute $r_0 = b - Ax_0$, $z_0 = A^T r_0$, $p_0 = z_0$.
 2. For $i = 0, \dots$, until convergence Do:
 3. $w_i = A p_i$
 4. $\alpha_i = \|z_i\|^2 / \|w_i\|_2^2$
 5. $x_{i+1} = x_i + \alpha_i p_i$
 6. $r_{i+1} = r_i - \alpha_i w_i$
 7. $z_{i+1} = A^T r_{i+1}$
 8. $\beta_i = \|z_{i+1}\|_2^2 / \|z_i\|_2^2$,
 9. $p_{i+1} = z_{i+1} + \beta_i p_i$
 10. EndDo
-

In Chapter 6, the approximation x_m produced at the m -th step of the Conjugate Gradient algorithm was shown to minimize the energy norm of the error over an affine Krylov

subspace. In this case, x_m minimizes the function

$$f(x) \equiv (A^T A(x_* - x), (x_* - x))$$

over all vectors x in the affine Krylov subspace

$$x_0 + \mathcal{K}_m(A^T A, A^T r_0) = x_0 + \text{span}\{A^T r_0, A^T A A^T r_0, \dots, (A^T A)^{m-1} A^T r_0\},$$

in which $r_0 = b - Ax_0$ is the initial residual with respect to the original equations $Ax = b$, and $A^T r_0$ is the residual with respect to the normal equations $A^T Ax = A^T b$. However, observe that

$$f(x) = (A(x_* - x), A(x_* - x)) = \|b - Ax\|_2^2.$$

Therefore, CGNR produces the approximate solution in the above subspace which has the smallest residual norm with respect to the original linear system $Ax = b$. The difference with the GMRES algorithm seen in Chapter 6, is the subspace in which the residual norm is minimized.

Example 8.1 Table 8.1 shows the results of applying the CGNR algorithm with no preconditioning to three of the test problems described in Section 3.7.

Matrix	Iters	Kflops	Residual	Error
F2DA	300	4847	0.23E+02	0.62E+00
F3D	300	23704	0.42E+00	0.15E+00
ORS	300	5981	0.30E+02	0.60E-02

Table 8.1 A test run of CGNR with no preconditioning.

See Example 6.1 for the meaning of the column headers in the table. The method failed to converge in less than 300 steps for all three problems. Failures of this type, characterized by very slow convergence, are rather common for CGNE and CGNR applied to problems arising from partial differential equations. Preconditioning should improve performance somewhat but, as will be seen in Chapter 10, normal equations are also difficult to precondition.

8.3.2 CGNE

A similar reorganization of the CG algorithm is possible for the system (8.3) as well. Applying the CG algorithm directly to (8.3) and denoting by q_i the conjugate directions, the actual CG iteration for the u variable would be as follows:

- $\alpha_j := (r_j, r_j) / (AA^T q_j, q_j) = (r_j, r_j) / (A^T q_j, A^T q_j)$
- $u_{j+1} := u_j + \alpha_j q_j$
- $r_{j+1} := r_j - \alpha_j AA^T q_j$
- $\beta_j := (r_{j+1}, r_{j+1}) / (r_j, r_j)$

- $q_{j+1} := r_{j+1} + \beta_j q_j$.

Notice that an iteration can be written with the original variable $x_i = x_0 + A^T(u_i - u_0)$ by introducing the vector $p_i = A^T q_i$. Then, the residual vectors for the vectors x_i and u_i are the same. No longer are the q_i vectors needed because the p_i 's can be obtained as $p_{j+1} := A^T r_{j+1} + \beta_j p_j$. The resulting algorithm described below, the Conjugate Gradient for the normal equations (CGNE), is also known as Craig's method.

ALGORITHM 8.5: CGNE (Craig's Method)

1. Compute $r_0 = b - Ax_0$, $p_0 = A^T r_0$.
 2. For $i = 0, 1, \dots$, until convergence Do:
 3. $\alpha_i = (r_i, r_i) / (p_i, p_i)$
 4. $x_{i+1} = x_i + \alpha_i p_i$
 5. $r_{i+1} = r_i - \alpha_i A p_i$
 6. $\beta_i = (r_{i+1}, r_{i+1}) / (r_i, r_i)$
 7. $p_{i+1} = A^T r_{i+1} + \beta_i p_i$
 8. EndDo
-

We now explore the optimality properties of this algorithm, as was done for CGNR. The approximation u_m related to the variable x_m by $x_m = A^T u_m$ is the actual m -th CG approximation for the linear system (8.3). Therefore, it minimizes the energy norm of the error on the Krylov subspace \mathcal{K}_m . In this case, u_m minimizes the function

$$f(u) \equiv (AA^T(u_* - u), (u_* - u))$$

over all vectors u in the affine Krylov subspace,

$$u_0 + \mathcal{K}_m(AA^T, r_0) = u_0 + \text{span}\{r_0, AA^T r_0, \dots, (AA^T)^{m-1} r_0\}.$$

Notice that $r_0 = b - AA^T u_0 = b - Ax_0$. Also, observe that

$$f(u) = (A^T(u_* - u), A^T(u_* - u)) = \|x_* - x\|_2^2,$$

where $x = A^T u$. Therefore, CGNE produces the approximate solution in the subspace

$$x_0 + A^T \mathcal{K}_m(AA^T, r_0) = x_0 + \mathcal{K}_m(A^T A, A^T r_0)$$

which has the smallest 2-norm of the error. In addition, note that the subspace $x_0 + \mathcal{K}_m(A^T A, A^T r_0)$ is identical with the subspace found for CGNR. Therefore, *the two methods find approximations from the same subspace which achieve different optimality properties: minimal residual for CGNR and minimal error for CGNE.*

SADDLE-POINT PROBLEMS

8.4

Now consider the equivalent system

$$\begin{pmatrix} I & A \\ A^T & O \end{pmatrix} \begin{pmatrix} r \\ x \end{pmatrix} = \begin{pmatrix} b \\ 0 \end{pmatrix}$$

with $r = b - Ax$. This system can be derived from the necessary conditions applied to the constrained least-squares problem (8.6–8.7). Thus, the 2-norm of $b - r = Ax$ is minimized implicitly under the constraint $A^T r = 0$. Note that A does not have to be a square matrix.

This can be extended into a more general constrained quadratic optimization problem as follows:

$$\text{minimize } f(x) \equiv \frac{1}{2}(Ax, x) - (x, b) \quad (8.28)$$

$$\text{subject to } B^T x = c. \quad (8.29)$$

The necessary conditions for optimality yield the linear system

$$\begin{pmatrix} A & B \\ B^T & O \end{pmatrix} \begin{pmatrix} x \\ y \end{pmatrix} = \begin{pmatrix} b \\ c \end{pmatrix} \quad (8.30)$$

in which the names of the variables r, x are changed into x, y for notational convenience. It is assumed that the column dimension of B does not exceed its row dimension. The Lagrangian for the above optimization problem is

$$L(x, y) = \frac{1}{2}(Ax, x) - (x, b) + (y, (B^T x - c))$$

and the solution of (8.30) is the saddle point of the above Lagrangian. Optimization problems of the form (8.28–8.29) and the corresponding linear systems (8.30) are important and arise in many applications. Because they are intimately related to the normal equations, we discuss them briefly here.

In the context of fluid dynamics, a well known iteration technique for solving the linear system (8.30) is Uzawa's method, which resembles a relaxed block SOR iteration.

ALGORITHM 8.6: Uzawa's Method

1. Choose x_0, y_0
2. For $k = 0, 1, \dots$, until convergence Do:
 3. $x_{k+1} = A^{-1}(b - By_k)$
 4. $y_{k+1} = y_k + \omega(B^T x_{k+1} - c)$
5. EndDo

The algorithm requires the solution of the linear system

$$Ax_{k+1} = b - By_k \quad (8.31)$$

at each iteration. By substituting the result of line 3 into line 4, the x_k iterates can be

eliminated to obtain the following relation for the y_k 's,

$$y_{k+1} = y_k + \omega (B^T A^{-1}(b - By_k) - c)$$

which is nothing but a Richardson iteration for solving the linear system

$$B^T A^{-1} B y = B^T A^{-1} b - c. \quad (8.32)$$

Apart from a sign, this system is the reduced system resulting from eliminating the x variable from (8.30). Convergence results can be derived from the analysis of the Richardson iteration.

COROLLARY 8.1 *Let A be a Symmetric Positive Definite matrix and B a matrix of full rank. Then $S = B^T A^{-1} B$ is also Symmetric Positive Definite and Uzawa's algorithm converges, if and only if*

$$0 < \omega < \frac{2}{\lambda_{max}(S)}. \quad (8.33)$$

In addition, the optimal convergence parameter ω is given by

$$\omega_{opt} = \frac{2}{\lambda_{min}(S) + \lambda_{max}(S)}.$$

Proof. The proof of this result is straightforward and is based on the results seen in Example 4.1. ■

It is interesting to observe that when $c = 0$ and A is Symmetric Positive Definite, then the system (8.32) can be regarded as the normal equations for minimizing the A^{-1} -norm of $b - By$. Indeed, the optimality conditions are equivalent to the orthogonality conditions

$$(b - By, Bw)_{A^{-1}} = 0, \quad \forall w,$$

which translate into the linear system $B^T A^{-1} B y = B^T A^{-1} b$. As a consequence, the problem will tend to be easier to solve if the columns of B are almost orthogonal with respect to the A^{-1} inner product. This is true when solving the *Stokes problem* where B represents the discretization of the gradient operator while B^T discretizes the divergence operator, and A is the discretization of a Laplacian. In this case, if it were not for the boundary conditions, the matrix $B^T A^{-1} B$ would be the identity. This feature can be exploited in developing preconditioners for solving problems of the form (8.30). Another particular case is when A is the identity matrix and $c = 0$. Then, the linear system (8.32) becomes the system of the normal equations for minimizing the 2-norm of $b - By$. These relations provide insight in understanding that the block form (8.30) is actually a form of normal equations for solving $By = b$ in the least-squares sense. However, a different inner product is used.

In Uzawa's method, a linear system at each step must be solved, namely, the system (8.31). Solving this system is equivalent to finding the minimum of the quadratic function

$$\text{minimize } f_k(x) \equiv \frac{1}{2}(Ax, x) - (x, b - By_k). \quad (8.34)$$

Apart from constants, $f_k(x)$ is the Lagrangian evaluated at the previous y iterate. The solution of (8.31), or the equivalent optimization problem (8.34), is expensive. A common alternative replaces the x -variable update (8.31) by taking one step in the gradient direction

for the quadratic function (8.34), usually with fixed step-length ϵ . The gradient of $f_k(x)$ at the current iterate is $Ax_k - (b - By_k)$. This results in the Arrow-Hurwicz Algorithm.

ALGORITHM 8.7: The Arrow-Hurwicz algorithm

1. Select an initial guess x_0, y_0 to the system (8.30)
 2. For $k = 0, 1, \dots$, until convergence Do:
 3. Compute $x_{k+1} = x_k + \epsilon(b - Ax_k - By_k)$
 4. Compute $y_{k+1} = y_k + \omega(B^T x_{k+1} - c)$
 5. EndDo
-

The above algorithm is a block-iteration of the form

$$\begin{pmatrix} I & O \\ -\omega B^T & I \end{pmatrix} \begin{pmatrix} x_{k+1} \\ y_{k+1} \end{pmatrix} = \begin{pmatrix} I - \epsilon A & -\epsilon B \\ O & I \end{pmatrix} \begin{pmatrix} x_k \\ y_k \end{pmatrix} + \begin{pmatrix} \epsilon b \\ -\omega c \end{pmatrix}.$$

Uzawa's method, and many similar techniques for solving (8.30), are based on solving the reduced system (8.32). An important observation here is that the Schur complement matrix $S \equiv B^T A^{-1} B$ need not be formed explicitly. This can be useful if this reduced system is to be solved by an iterative method. The matrix A is typically factored by a Cholesky-type factorization. The linear systems with the coefficient matrix A can also be solved by a preconditioned Conjugate Gradient method. Of course these systems must then be solved accurately.

Sometimes it is useful to "regularize" the least-squares problem (8.28) by solving the following problem in its place:

$$\begin{aligned} &\text{minimize } f(x) \equiv \frac{1}{2}(Ax, x) - (x, b) + \rho(Cy, y) \\ &\text{subject to } B^T x = c \end{aligned}$$

in which ρ is a scalar parameter. For example, C can be the identity matrix or the matrix $B^T B$. The matrix resulting from the Lagrange multipliers approach then becomes

$$\begin{pmatrix} A & B \\ B^T & \rho C \end{pmatrix}.$$

The new Schur complement matrix is

$$S = \rho C - B^T A^{-1} B.$$

Example 8.2 In the case where $C = B^T B$, the above matrix takes the form

$$S = B^T(\rho I - A^{-1})B.$$

Assuming that A is SPD, S is also positive definite when

$$\rho \geq \frac{1}{\lambda_{\min}(A)}.$$

However, it is also *negative definite* for

$$\rho \leq \frac{1}{\lambda_{\max}(A)},$$

a condition which may be easier to satisfy on practice.

EXERCISES

1. Derive the linear system (8.5) by expressing the standard necessary conditions for the problem (8.6–8.7).
2. It was stated in Section 8.2.2 that when $\|A^T e_i\|_2 = 1$ for $i = 1, \dots, n$, the vector d defined in Algorithm 8.3 is equal to $\omega A^T r$.
 - a. What does this become in the general situation when $\|A^T e_i\|_2 \neq 1$?
 - b. Is Cimmino's method still equivalent to a Richardson iteration?
 - c. Show convergence results similar to those of the scaled case.
3. In Section 8.2.2, Cimmino's algorithm was derived based on the Normal Residual formulation, i.e., on (8.1). Derive an "NE" formulation, i.e., an algorithm based on Jacobi's method for (8.3).
4. What are the eigenvalues of the matrix (8.5)? Derive a system whose coefficient matrix has the form

$$B(\alpha) = \begin{pmatrix} 2\alpha I & A \\ A^T & O \end{pmatrix}.$$

and which is also equivalent to the original system $Ax = b$. What are the eigenvalues of $B(\alpha)$? Plot the spectral norm of $B(\alpha)$ as a function of α .

5. It was argued in Section 8.4 that when $c = 0$ the system (8.32) is nothing but the normal equations for minimizing the A^{-1} -norm of the residual $r = b - By$.
 - a. Write the associated CGNR approach for solving this problem. Find a variant that requires only one linear system solution with the matrix A at each CG step [Hint: Write the CG algorithm for the associated normal equations and see how the resulting procedure can be reorganized to save operations]. Find also a variant that is suitable for the case where the Cholesky factorization of A is available.
 - b. Derive a method for solving the equivalent system (8.30) for the case when $c = 0$ and then for the general case when $c \neq 0$. How does this technique compare with Uzawa's method?
6. Consider the linear system (8.30) in which $c = 0$ and B is of full rank. Define the matrix

$$P = I - B(B^T B)^{-1} B^T.$$

- a. Show that P is a projector. Is it an orthogonal projector? What are the range and null spaces of P ?
- b. Show that the unknown x can be found by solving the linear system

$$PAPx = Pb, \tag{8.35}$$

in which the coefficient matrix is singular but the system is consistent, i.e., there is a nontrivial solution because the right-hand side is in the range of the matrix (see Chapter 1).

- c. What must be done to adapt the Conjugate Gradient Algorithm for solving the above linear system (which is symmetric, but not positive definite)? In which subspace are the iterates generated from the CG algorithm applied to (8.35)?

d. Assume that the QR factorization of the matrix B is computed. Write an algorithm based on the approach of the previous questions for solving the linear system (8.30).

7. Show that Uzawa's iteration can be formulated as a fixed-point iteration associated with the splitting $C = M - N$ with

$$M = \begin{pmatrix} A & O \\ -\omega B^T & I \end{pmatrix}, \quad N = \begin{pmatrix} O & -B \\ O & I \end{pmatrix}.$$

Derive the convergence result of Corollary 8.1 .

8. Show that each new vector iterate in Cimmino's method is such that

$$x_{n\epsilon w} = x + \omega A^{-1} \sum_i P_i r,$$

where P_i is defined by (8.24).

9. In Uzawa's method a linear system with the matrix A must be solved at each step. Assume that these systems are solved inaccurately by an iterative process. For each linear system the iterative process is applied until the norm of the residual $r_{k+1} = (b - By_k) - Ax_{k+1}$ is less than a certain threshold ϵ_{k+1} .

a. Assume that ω is chosen so that (8.33) is satisfied and that ϵ_k converges to zero as k tends to infinity. Show that the resulting algorithm converges to the solution.

b. Give an explicit upper bound of the error on y_k in the case when ϵ_i is chosen of the form $\epsilon = \alpha^i$, where $\alpha < 1$.

10. Assume $\|b - Ax\|_2$ is to be minimized, in which A is $n \times m$ with $n > m$. Let x_* be the minimizer and $r = b - Ax_*$. What is the minimizer of $\|(b + \alpha r) - Ax\|_2$, where α is an arbitrary scalar?

NOTES AND REFERENCES. Methods based on the normal equations have been among the first to be used for solving nonsymmetric linear systems [130, 58] by iterative methods. The work by Bjork and Elfing [27], and Sameh et al. [131, 37, 36] revived these techniques by showing that they have some advantages from the implementation point of view, and that they can offer good performance for a broad class of problems. In addition, they are also attractive for parallel computers. In [174], a few preconditioning ideas for normal equations were described and these will be covered in Chapter 10. It would be helpful to be able to determine whether or not it is preferable to use the normal equations approach rather than the "direct equations" for a given system, but this may require an eigenvalue/singular value analysis.

It is sometimes argued that the normal equations approach is *always* better, because it has a robust quality which outweighs the additional cost due to the slowness of the method in the generic elliptic case. Unfortunately, this is not true. Although variants of the Kaczmarz and Cimmino algorithms deserve a place in any robust iterative solution package, they cannot be viewed as a panacea. In *most* realistic examples arising from Partial Differential Equations, the normal equations route gives rise to much slower convergence than the Krylov subspace approach for the direct equations. For ill-conditioned problems, these methods will simply fail to converge, unless a good preconditioner is available. ■

PRECONDITIONED ITERATIONS

Although the methods seen in previous chapters are well founded theoretically, they are all likely to suffer from slow convergence for problems which arise from typical applications such as fluid dynamics or electronic device simulation. Preconditioning is a key ingredient for the success of Krylov subspace methods in these applications. This chapter discusses the preconditioned versions of the iterative methods already seen, but without being specific about the particular preconditioners used. The standard preconditioning techniques will be covered in the next chapter.

INTRODUCTION

9.1

Lack of robustness is a widely recognized weakness of iterative solvers, relative to direct solvers. This drawback hampers the acceptance of iterative methods in industrial applications despite their intrinsic appeal for very large linear systems. Both the efficiency and robustness of iterative techniques can be improved by using *preconditioning*. A term introduced in Chapter 4, preconditioning is simply a means of transforming the original linear system into one which has the same solution, but which is likely to be easier to solve with an iterative solver. In general, the reliability of iterative techniques, when dealing with various applications, depends much more on the quality of the preconditioner than on the particular Krylov subspace accelerators used. We will cover some of these preconditioners in detail in the next chapter. This chapter discusses the preconditioned versions of the Krylov subspace algorithms already seen, using a generic preconditioner.

PRECONDITIONED CONJUGATE GRADIENT

9.2

Consider a matrix A that is symmetric and positive definite and assume that a preconditioner M is available. The preconditioner M is a matrix which approximates A in some yet-undefined sense. It is assumed that M is also Symmetric Positive Definite. From a practical point of view, the only requirement for M is that it is inexpensive to solve linear systems $Mx = b$. This is because the preconditioned algorithms will all require a linear system solution with the matrix M at each step. Then, for example, the following preconditioned system could be solved:

$$M^{-1}Ax = M^{-1}b \quad (9.1)$$

or

$$AM^{-1}u = b, \quad x = M^{-1}u. \quad (9.2)$$

Note that these two systems are no longer symmetric in general. The next section considers strategies for preserving symmetry. Then, efficient implementations will be described for particular forms of the preconditioners.

9.2.1 PRESERVING SYMMETRY

When M is available in the form of an incomplete Cholesky factorization, i.e., when

$$M = LL^T,$$

then a simple way to preserve symmetry is to “split” the preconditioner between left and right, i.e., to solve

$$L^{-1}AL^{-T}u = L^{-1}b, \quad x = L^{-T}u, \quad (9.3)$$

which involves a Symmetric Positive Definite matrix.

However, it is not necessary to split the preconditioner in this manner in order to preserve symmetry. Observe that $M^{-1}A$ is self-adjoint for the M -inner product,

$$(x, y)_M \equiv (Mx, y) = (x, My)$$

since

$$(M^{-1}Ax, y)_M = (Ax, y) = (x, Ay) = (x, M(M^{-1}A)y) = (x, M^{-1}Ay)_M.$$

Therefore, an alternative is to replace the usual Euclidean inner product in the Conjugate Gradient algorithm by the M -inner product.

If the CG algorithm is rewritten for this new inner product, denoting by $r_j = b - Ax_j$ the original residual and by $z_j = M^{-1}r_j$ the residual for the preconditioned system, the following sequence of operations is obtained, ignoring the initial step:

1. $\alpha_j := (z_j, z_j)_M / (M^{-1}Ap_j, p_j)_M$
2. $x_{j+1} := x_j + \alpha_j p_j$

3. $r_{j+1} := r_j - \alpha_j A p_j$ and $z_{j+1} := M^{-1} r_{j+1}$
4. $\beta_j := (z_{j+1}, z_{j+1})_M / (z_j, z_j)_M$
5. $p_{j+1} := z_{j+1} + \beta_j p_j$

Since $(z_j, z_j)_M = (r_j, z_j)$ and $(M^{-1} A p_j, p_j)_M = (A p_j, p_j)$, the M -inner products do not have to be computed explicitly. With this observation, the following algorithm is obtained.

ALGORITHM 9.1: Preconditioned Conjugate Gradient

1. Compute $r_0 := b - A x_0$, $z_0 = M^{-1} r_0$, and $p_0 := z_0$
 2. For $j = 0, 1, \dots$, until convergence Do:
 3. $\alpha_j := (r_j, z_j) / (A p_j, p_j)$
 4. $x_{j+1} := x_j + \alpha_j p_j$
 5. $r_{j+1} := r_j - \alpha_j A p_j$
 6. $z_{j+1} := M^{-1} r_{j+1}$
 7. $\beta_j := (r_{j+1}, z_{j+1}) / (r_j, z_j)$
 8. $p_{j+1} := z_{j+1} + \beta_j p_j$
 9. EndDo
-

It is interesting to observe that $M^{-1} A$ is also self-adjoint with respect to the A inner-product. Indeed,

$$(M^{-1} A x, y)_A = (A M^{-1} A x, y) = (x, A M^{-1} A y) = (x, M^{-1} A y)_A$$

and a similar algorithm can be written for this dot product (see Exercise 1).

In the case where M is a Cholesky product $M = L L^T$, two options are available, namely, the split preconditioning option (9.3), or the above algorithm. An immediate question arises about the iterates produced by these two options: Is one better than the other? Surprisingly, the answer is that *the iterates are identical*. To see this, start from Algorithm 9.1 and define the following auxiliary vectors and matrix from it:

$$\begin{aligned}\hat{p}_j &= L^T p_j \\ u_j &= L^T x_j \\ \hat{r}_j &= L^T z_j = L^{-1} r_j \\ \hat{A} &= L^{-1} A L^{-T}.\end{aligned}$$

Observe that

$$(r_j, z_j) = (r_j, L^{-T} L^{-1} r_j) = (L^{-1} r_j, L^{-1} r_j) = (\hat{r}_j, \hat{r}_j).$$

Similarly,

$$(A p_j, p_j) = (A L^{-T} \hat{p}_j, L^{-T} \hat{p}_j) (L^{-1} A L^{-T} \hat{p}_j, \hat{p}_j) = (\hat{A} \hat{p}_j, \hat{p}_j).$$

All the steps of the algorithm can be rewritten with the new variables, yielding the following sequence of operations:

1. $\alpha_j := (\hat{r}_j, \hat{r}_j) / (\hat{A} \hat{p}_j, \hat{p}_j)$
2. $u_{j+1} := u_j + \alpha_j \hat{p}_j$

3. $\hat{r}_{j+1} := \hat{r}_j - \alpha_j \hat{A} \hat{p}_j$
4. $\beta_j := (\hat{r}_{j+1}, \hat{r}_{j+1}) / (\hat{r}_j, \hat{r}_j)$
5. $\hat{p}_{j+1} := \hat{r}_{j+1} + \beta_j \hat{p}_j$.

This is precisely the Conjugate Gradient algorithm applied to the preconditioned system

$$\hat{A}u = L^{-1}b$$

where $u = L^T x$. It is common when implementing algorithms which involve a right preconditioner to avoid the use of the u variable, since the iteration can be written with the original x variable. If the above steps are rewritten with the original x and p variables, the following algorithm results.

ALGORITHM 9.2: Split Preconditioner Conjugate Gradient

1. Compute $r_0 := b - Ax_0$; $\hat{r}_0 = L^{-1}r_0$; and $p_0 := L^{-T}\hat{r}_0$.
 2. For $j = 0, 1, \dots$, until convergence Do:
 3. $\alpha_j := (\hat{r}_j, \hat{r}_j) / (Ap_j, p_j)$
 4. $x_{j+1} := x_j + \alpha_j p_j$
 5. $\hat{r}_{j+1} := \hat{r}_j - \alpha_j L^{-1}Ap_j$
 6. $\beta_j := (\hat{r}_{j+1}, \hat{r}_{j+1}) / (\hat{r}_j, \hat{r}_j)$
 7. $p_{j+1} := L^{-T}\hat{r}_{j+1} + \beta_j p_j$
 8. EndDo
-

The iterates x_j produced by the above algorithm and Algorithm 9.1 are identical, provided the same initial guess is used.

Consider now the right preconditioned system (9.2). The matrix AM^{-1} is not Hermitian with either the Standard inner product or the M -inner product. However, it is Hermitian with respect to the M^{-1} -inner product. If the CG-algorithm is written with respect to the u -variable and for this new inner product, the following sequence of operations would be obtained, ignoring again the initial step:

1. $\alpha_j := (r_j, r_j)_{M^{-1}} / (AM^{-1}p_j, p_j)_{M^{-1}}$
2. $u_{j+1} := u_j + \alpha_j p_j$
3. $r_{j+1} := r_j - \alpha_j AM^{-1}p_j$
4. $\beta_j := (r_{j+1}, r_{j+1})_{M^{-1}} / (r_j, r_j)_{M^{-1}}$
5. $p_{j+1} := r_{j+1} + \beta_j p_j$.

Recall that the u vectors and the x vectors are related by $x = M^{-1}u$. Since the u vectors are not actually needed, the update for u_{j+1} in the second step can be replaced by $x_{j+1} := x_j + \alpha_j M^{-1}p_j$. Then observe that the whole algorithm can be recast in terms of $q_j = M^{-1}p_j$ and $z_j = M^{-1}r_j$.

1. $\alpha_j := (z_j, r_j) / (Aq_j, q_j)$
2. $x_{j+1} := x_j + \alpha_j q_j$
3. $r_{j+1} := r_j - \alpha_j Aq_j$ and $z_{j+1} = M^{-1}r_{j+1}$
4. $\beta_j := (z_{j+1}, r_{j+1}) / (z_j, r_j)$

$$5. q_{j+1} := z_{j+1} + \beta_j q_j.$$

Notice that the same sequence of computations is obtained as with Algorithm 9.1, the left preconditioned Conjugate Gradient. The implication is that *the left preconditioned CG algorithm with the M -inner product is mathematically equivalent to the right preconditioned CG algorithm with the M^{-1} -inner product.*

9.2.2 EFFICIENT IMPLEMENTATIONS

When applying a Krylov subspace procedure to a preconditioned linear system, an operation of the form

$$v \rightarrow w = M^{-1}Av$$

or some similar operation is performed at each step. The most natural way to perform this operation is to multiply the vector v by A and then apply M^{-1} to the result. However, since A and M are related, it is sometimes possible to devise procedures that are more economical than this straightforward approach. For example, it is often the case that

$$M = A - R$$

in which the number of nonzero elements in R is much smaller than in A . In this case, the simplest scheme would be to compute $w = M^{-1}Av$ as

$$w = M^{-1}Av = M^{-1}(M + R)v = v + M^{-1}Rv.$$

This requires that R be stored explicitly. In approximate LU factorization techniques, R is the matrix of the elements that are dropped during the incomplete factorization. An even more efficient variation of the preconditioned Conjugate Gradient algorithm can be derived for some common forms of the preconditioner in the special situation where A is symmetric. Write A in the form

$$A = D_0 - E - E^T \tag{9.4}$$

in which $-E$ is the strict lower triangular part of A and D_0 its diagonal. In many cases, the preconditioner M can be written in the form

$$M = (D - E)D^{-1}(D - E^T) \tag{9.5}$$

in which E is the same as above and D is some diagonal, not necessarily equal to D_0 . For example, in the SSOR preconditioner with $\omega = 1$, $D \equiv D_0$. Also, for certain types of matrices, the IC(0) preconditioner can be expressed in this manner, where D can be obtained by a recurrence formula.

Eisenstat's implementation consists of applying the Conjugate Gradient algorithm to the linear system

$$\hat{A}u = (D - E)^{-1}b \tag{9.6}$$

with

$$\hat{A} \equiv (D - E)^{-1}A(D - E^T)^{-1}, \quad x = (D - E^T)^{-1}u. \tag{9.7}$$

This does not quite correspond to a preconditioning with the matrix (9.5). In order to produce the same iterates as Algorithm 9.1, the matrix \hat{A} must be further preconditioned with the diagonal matrix D^{-1} . Thus, the preconditioned CG algorithm, Algorithm 9.1, is actually applied to the system (9.6) in which the preconditioning operation is $M^{-1} = D$. Alternatively, we can initially scale the rows and columns of the linear system and preconditioning to transform the diagonal to the identity. See Exercise 6.

Now note that

$$\begin{aligned}\hat{A} &= (D - E)^{-1} A (D - E^T)^{-1} \\ &= (D - E)^{-1} (D_0 - E - E^T) (D - E^T)^{-1} \\ &= (D - E)^{-1} (D_0 - 2D + (D - E) + (D - E^T)) (D - E^T)^{-1} \\ &\equiv (D - E)^{-1} D_1 (D - E^T)^{-1} + (D - E)^{-1} + (D - E^T)^{-1},\end{aligned}$$

in which $D_1 \equiv D_0 - 2D$. As a result,

$$\hat{A}v = (D - E)^{-1} [v + D_1 (D - E^T)^{-1} v] + (D - E^T)^{-1} v.$$

Thus, the vector $w = \hat{A}v$ can be computed by the following procedure:

$$\begin{aligned}z &:= (D - E^T)^{-1} v \\ w &:= (D - E)^{-1} (v + D_1 z) \\ w &:= w + z.\end{aligned}$$

One product with the diagonal D can be saved if the matrices $D^{-1}E$ and $D^{-1}E^T$ are stored. Indeed, by setting $\hat{D}_1 = D^{-1}D_1$ and $\hat{v} = D^{-1}v$, the above procedure can be reformulated as follows.

ALGORITHM 9.3: Computation of $w = \hat{A}v$

1. $\hat{v} := D^{-1}v$
 2. $z := (I - D^{-1}E^T)^{-1}\hat{v}$
 3. $w := (I - D^{-1}E)^{-1}(\hat{v} + \hat{D}_1 z)$
 4. $w := w + z$.
-

Note that the matrices $D^{-1}E$ and $D^{-1}E^T$ are not the transpose of one another, so we actually need to increase the storage requirement for this formulation if these matrices are stored. However, there is a more economical variant which works with the matrix $D^{-1/2}ED^{-1/2}$ and its transpose. This is left as Exercise 7.

Denoting by $N_z(X)$ the number of nonzero elements of a sparse matrix X , the total number of operations (additions and multiplications) of this procedure is n for (1), $2N_z(E)$ for (2), $2N_z(E^T) + 2n$ for (3), and n for (4). The cost of the preconditioning operation by D^{-1} , i.e., n operations, must be added to this, yielding the total number of operations:

$$\begin{aligned}N_{op} &= n + 2N_z(E) + 2N_z(E^T) + 2n + n + n \\ &= 3n + 2(N_z(E) + N_z(E^T) + n) \\ &= 3n + 2N_z(A).\end{aligned}$$

For the straightforward approach, $2N_z(A)$ operations are needed for the product with A ,

$2N_z(E)$ for the forward solve, and $n + 2N_z(E^T)$ for the backward solve giving a total of

$$2N_z(A) + 2N_z(E) + n + 2N_z(E^T) = 4N_z(A) - n.$$

Thus, Eisenstat's scheme is always more economical, when N_z is large enough, although the relative gains depend on the total number of nonzero elements in A . One disadvantage of this scheme is that it is limited to a special form of the preconditioner.

Example 9.1 For a 5-point finite difference matrix, $N_z(A)$ is roughly $5n$, so that with the standard implementation $19n$ operations are performed, while with Eisenstat's implementation only $13n$ operations would be performed, a savings of about $\frac{1}{3}$. However, if the other operations of the Conjugate Gradient algorithm are included, for a total of about $10n$ operations, the relative savings become smaller. Now the original scheme will require $29n$ operations, versus $23n$ operations for Eisenstat's implementation.

PRECONDITIONED GMRES

9.3

In the case of GMRES, or other nonsymmetric iterative solvers, the same three options for applying the preconditioning operation as for the Conjugate Gradient (namely, left, split, and right preconditioning) are available. However, there will be one fundamental difference – the right preconditioning versions will give rise to what is called a *flexible variant*, i.e., a variant in which the preconditioner can change at each step. This capability can be very useful in some applications.

9.3.1 LEFT-PRECONDITIONED GMRES

As before, define the left preconditioned GMRES algorithm, as the GMRES algorithm applied to the system,

$$M^{-1}Ax = M^{-1}b. \quad (9.8)$$

The straightforward application of GMRES to the above linear system yields the following preconditioned version of GMRES.

ALGORITHM 9.4: GMRES with Left Preconditioning

1. Compute $r_0 = M^{-1}(b - Ax_0)$, $\beta = \|r_0\|_2$ and $v_1 = r_0/\beta$
2. For $j = 1, \dots, m$ Do:
3. Compute $w := M^{-1}Av_j$
4. For $i = 1, \dots, j$, Do:
5. $h_{i,j} := (w, v_i)$
6. $w := w - h_{i,j}v_i$

7. *EndDo*
8. *Compute* $h_{j+1,j} = \|w\|_2$ *and* $v_{j+1} = w/h_{j+1,j}$
9. *EndDo*
10. *Define* $V_m := [v_1, \dots, v_m]$, $\bar{H}_m = \{h_{i,j}\}_{1 \leq i \leq j+1; 1 \leq j \leq m}$
11. *Compute* $y_m = \operatorname{argmin}_y \|\beta e_1 - \bar{H}_m y\|_2$, *and* $x_m = x_0 + V_m y_m$
12. *If satisfied Stop, else set* $x_0 := x_m$ *and* *GoTo* 1

The Arnoldi loop constructs an orthogonal basis of the left preconditioned Krylov subspace

$$\operatorname{Span}\{r_0, M^{-1}Ar_0, \dots, (M^{-1}A)^{m-1}r_0\}.$$

It uses a modified Gram-Schmidt process, in which the new vector to be orthogonalized is obtained from the previous vector in the process. All residual vectors and their norms that are computed by the algorithm correspond to the preconditioned residuals, namely, $z_m = M^{-1}(b - Ax_m)$, instead of the original (unpreconditioned) residuals $b - Ax_m$. In addition, there is no easy access to these unpreconditioned residuals, unless they are computed explicitly, e.g., by multiplying the preconditioned residuals by M . This can cause some difficulties if a stopping criterion based on the actual residuals, instead of the preconditioned ones, is desired.

Sometimes a Symmetric Positive Definite preconditioning M for the nonsymmetric matrix A may be available. For example, if A is almost SPD, then (9.8) would not take advantage of this. It would be wiser to compute an approximate factorization to the symmetric part and use GMRES with split preconditioning. This raises the question as to whether or not a version of the preconditioned GMRES can be developed, which is similar to Algorithm 9.1, for the CG algorithm. This version would consist of using GMRES with the M -inner product for the system (9.8).

At step j of the preconditioned GMRES algorithm, the previous v_j is multiplied by A to get a vector

$$w_j = Av_j. \quad (9.9)$$

Then this vector is preconditioned to get

$$z_j = M^{-1}w_j. \quad (9.10)$$

This vector must be M -orthogonalized against all previous v_i 's. If the standard Gram-Schmidt process is used, we first compute the inner products

$$h_{ij} = (z_j, v_i)_M = (Mz_j, v_i) = (w_j, v_i), \quad i = 1, \dots, j, \quad (9.11)$$

and then modify the vector z_j into the new vector

$$\hat{z}_j := z_j - \sum_{i=1}^j h_{ij}v_i. \quad (9.12)$$

To complete the orthonormalization step, the final \hat{z}_j must be normalized. Because of the orthogonality of \hat{z}_j versus all previous v_i 's, observe that

$$(\hat{z}_j, \hat{z}_j)_M = (z_j, \hat{z}_j)_M = (M^{-1}w_j, \hat{z}_j)_M = (w_j, \hat{z}_j). \quad (9.13)$$

Thus, the desired M -norm could be obtained from (9.13), and then we would set

$$h_{j+1,j} := (\hat{z}_j, w_j)^{1/2} \quad \text{and} \quad v_{j+1} = \hat{z}_j / h_{j+1,j}. \quad (9.14)$$

One serious difficulty with the above procedure is that the inner product $(\hat{z}_j, \hat{z}_j)_M$ as computed by (9.13) may be negative in the presence of round-off. There are two remedies. First, this M -norm can be computed explicitly at the expense of an additional matrix-vector multiplication with M . Second, the set of vectors Mv_i can be saved in order to accumulate inexpensively both the vector \hat{z}_j and the vector $M\hat{z}_j$, via the relation

$$M\hat{z}_j = w_j - \sum_{i=1}^j h_{ij} Mv_i.$$

A modified Gram-Schmidt version of this second approach can be derived easily. The details of the algorithm are left as Exercise 12.

9.3.2 RIGHT-PRECONDITIONED GMRES

The right preconditioned GMRES algorithm is based on solving

$$AM^{-1}u = b, \quad u = Mx. \quad (9.15)$$

As we now show, the new variable u never needs to be invoked explicitly. Indeed, once the initial residual $b - Ax_0 = b - AM^{-1}u_0$ is computed, all subsequent vectors of the Krylov subspace can be obtained without any reference to the u -variables. Note that u_0 is not needed at all. The initial residual for the preconditioned system can be computed from $r_0 = b - Ax_0$, which is the same as $b - AM^{-1}u_0$. In practice, it is usually x_0 that is available, not u_0 . At the end, the u -variable approximate solution to (9.15) is given by,

$$u_m = u_0 + \sum_{i=1}^m v_i \eta_i$$

with $u_0 = Mx_0$. Multiplying through by M^{-1} yields the desired approximation in terms of the x -variable,

$$x_m = x_0 + M^{-1} \left[\sum_{i=1}^m v_i \eta_i \right].$$

Thus, one preconditioning operation is needed at the end of the outer loop, instead of at the beginning in the case of the left preconditioned version.

ALGORITHM 9.5: GMRES with Right Preconditioning

1. Compute $r_0 = b - Ax_0$, $\beta = \|r_0\|_2$, and $v_1 = r_0/\beta$
2. For $j = 1, \dots, m$ Do:
3. Compute $w := AM^{-1}v_j$
4. For $i = 1, \dots, j$, Do:
5. $h_{i,j} := (w, v_i)$
6. $w := w - h_{i,j}v_i$
7. EndDo

8. Compute $h_{j+1,j} = \|w\|_2$ and $v_{j+1} = w/h_{j+1,j}$
9. Define $V_m := [v_1, \dots, v_m]$, $\bar{H}_m = \{h_{i,j}\}_{1 \leq i \leq j+1; 1 \leq j \leq m}$
10. EndDo
11. Compute $y_m = \operatorname{argmin}_y \|\beta e_1 - \bar{H}_m y\|_2$, and $x_m = x_0 + M^{-1}V_m y_m$.
12. If satisfied Stop, else set $x_0 := x_m$ and GoTo 1.

This time, the Arnoldi loop builds an orthogonal basis of the right preconditioned Krylov subspace

$$\operatorname{Span}\{r_0, AM^{-1}r_0, \dots, (AM^{-1})^{m-1}r_0\}.$$

Note that the residual norm is now relative to the initial system, i.e., $b - Ax_m$, since the algorithm obtains the residual $b - Ax_m = b - AM^{-1}u_m$, implicitly. This is an essential difference with the left preconditioned GMRES algorithm.

9.3.3 SPLIT PRECONDITIONING

In many cases, M is the result of a factorization of the form

$$M = LU.$$

Then, there is the option of using GMRES on the split-preconditioned system

$$L^{-1}AU^{-1}u = L^{-1}b, \quad x = U^{-1}u.$$

In this situation, it is clear that we need to operate on the initial residual by L^{-1} at the start of the algorithm and by U^{-1} on the linear combination $V_m y_m$ in forming the approximate solution. The residual norm available is that of $L^{-1}(b - Ax_m)$.

A question arises on the differences between the right, left, and split preconditioning options. The fact that different versions of the residuals are available in each case may affect the stopping criterion and may cause the algorithm to stop either prematurely or with delay. This can be particularly damaging in case M is very ill-conditioned. The degree of symmetry, and therefore performance, can also be affected by the way in which the preconditioner is applied. For example, a split preconditioner may be much better if A is nearly symmetric. Other than these two situations, there is little difference generally between the three options. The next section establishes a theoretical connection between left and right preconditioned GMRES.

9.3.4 COMPARISON OF RIGHT AND LEFT PRECONDITIONING

When comparing the left, right, and split preconditioning options, a first observation to make is that the spectra of the three associated operators $M^{-1}A$, AM^{-1} , and $L^{-1}AU^{-1}$ are identical. Therefore, in principle one should expect convergence to be similar, although, as is known, eigenvalues do not always govern convergence. In this section, we compare the optimality properties achieved by left- and right preconditioned GMRES.

For the left preconditioning option, GMRES minimizes the residual norm

$$\|M^{-1}b - M^{-1}Ax\|_2,$$

among all vectors from the affine subspace

$$x_0 + \mathcal{K}_m^L = x_0 + \text{Span} \{z_0, M^{-1}Az_0, \dots, (M^{-1}A)^{m-1}z_0\} \quad (9.16)$$

in which z_0 is the preconditioned initial residual $z_0 = M^{-1}r_0$. Thus, the approximate solution can be expressed as

$$x_m = x_0 + M^{-1}s_{m-1}(M^{-1}A)z_0$$

where s_{m-1} is the polynomial of degree $m - 1$ which minimizes the norm

$$\|z_0 - M^{-1}A s(M^{-1}A)z_0\|_2$$

among all polynomials s of degree $\leq m - 1$. It is also possible to express this optimality condition with respect to the original residual vector r_0 . Indeed,

$$z_0 - M^{-1}A s(M^{-1}A)z_0 = M^{-1} [r_0 - A s(M^{-1}A)M^{-1}r_0].$$

A simple algebraic manipulation shows that for any polynomial s ,

$$s(M^{-1}A)M^{-1}r = M^{-1}s(AM^{-1})r, \quad (9.17)$$

from which we obtain the relation

$$z_0 - M^{-1}A s(M^{-1}A)z_0 = M^{-1} [r_0 - AM^{-1}s(AM^{-1})r_0]. \quad (9.18)$$

Consider now the situation with the right preconditioned GMRES. Here, it is necessary to distinguish between the original x variable and the transformed variable u related to x by $x = M^{-1}u$. For the u variable, the right preconditioned GMRES process minimizes the 2-norm of $r = b - AM^{-1}u$ where u belongs to

$$u_0 + \mathcal{K}_m^R = u_0 + \text{Span} \{r_0, AM^{-1}r_0, \dots, (AM^{-1})^{m-1}r_0\} \quad (9.19)$$

in which r_0 is the residual $r_0 = b - AM^{-1}u_0$. This residual is identical to the residual associated with the original x variable since $M^{-1}u_0 = x_0$. Multiplying (9.19) through to the left by M^{-1} and exploiting again (9.17), observe that the generic variable x associated with a vector of the subspace (9.19) belongs to the affine subspace

$$M^{-1}u_0 + M^{-1}\mathcal{K}_m^R = x_0 + \text{Span} \{z_0, M^{-1}Az_0, \dots, (M^{-1}A)^{m-1}z_0\}.$$

This is identical to the affine subspace (9.16) invoked in the left preconditioned variant. In other words, for the right preconditioned GMRES, the approximate x -solution can also be expressed as

$$x_m = x_0 + s_{m-1}(AM^{-1})r_0.$$

However, now s_{m-1} is a polynomial of degree $m - 1$ which minimizes the norm

$$\|r_0 - AM^{-1}s(AM^{-1})r_0\|_2 \quad (9.20)$$

among all polynomials s of degree $\leq m - 1$. What is surprising is that the two quantities which are minimized, namely, (9.18) and (9.20), differ only by a multiplication by M^{-1} . Specifically, the left preconditioned GMRES minimizes $M^{-1}r$, whereas the right preconditioned variant minimizes r , where r is taken over the same subspace in both cases.

PROPOSITION 9.1 *The approximate solution obtained by left or right preconditioned GMRES is of the form*

$$x_m = x_0 + s_{m-1}(M^{-1}A)z_0 = x_0 + M^{-1}s_{m-1}(AM^{-1})r_0$$

where $z_0 = M^{-1}r_0$ and s_{m-1} is a polynomial of degree $m - 1$. The polynomial s_{m-1} minimizes the residual norm $\|b - Ax_m\|_2$ in the right preconditioning case, and the preconditioned residual norm $\|M^{-1}(b - Ax_m)\|_2$ in the left preconditioning case.

In most practical situations, the difference in the convergence behavior of the two approaches is not significant. The only exception is when M is ill-conditioned which could lead to substantial differences.

FLEXIBLE VARIANTS

9.4

In the discussion of preconditioning techniques so far, it is implicitly assumed that the preconditioning matrix M is fixed, i.e., it does not change from step to step. However, in some cases, no matrix M is available. Instead, the operation $M^{-1}x$ is the result of some unspecified computation, possibly another iterative process. In such cases, it may well happen that M^{-1} is not a constant operator. The previous preconditioned iterative procedures will not converge if M is not constant. There are a number of variants of iterative procedures developed in the literature that can accommodate variations in the preconditioner, i.e., that allow the preconditioner to vary from step to step. Such iterative procedures are called “flexible” iterations. One of these iterations, a flexible variant of the GMRES algorithm, is described next.

9.4.1 FLEXIBLE GMRES

We begin by examining the right preconditioned GMRES algorithm. In line 11 of Algorithm 9.5 the approximate solution x_m is expressed as a linear combination of the preconditioned vectors $z_i = M^{-1}v_i, i = 1, \dots, m$. These vectors are also computed in line 3, prior to their multiplication by A to obtain the vector w . They are all obtained by applying the same preconditioning matrix M^{-1} to the v_i 's. As a result it is not necessary to save them. Instead, we only need to apply M^{-1} to the linear combination of the v_i 's, i.e., to $V_m y_m$ in line 11. Suppose now that the preconditioner could change at every step, i.e., that z_j is given by

$$z_j = M_j^{-1}v_j.$$

Then it would be natural to compute the approximate solution as

$$x_m = x_0 + Z_m y_m$$

in which $Z_m = [z_1, \dots, z_m]$, and y_m is computed as before, as the solution to the least-squares problem in line 11. These are the only changes that lead from the right preconditioned algorithm to the flexible variant, described below.

ALGORITHM 9.6: Flexible GMRES (FGMRES)

1. Compute $r_0 = b - Ax_0$, $\beta = \|r_0\|_2$, and $v_1 = r_0/\beta$
 2. For $j = 1, \dots, m$ Do:
 3. Compute $z_j := M_j^{-1}v_j$
 4. Compute $w := Az_j$
 5. For $i = 1, \dots, j$, Do:
 6. $h_{i,j} := (w, v_i)$
 7. $w := w - h_{i,j}v_i$
 8. EndDo
 9. Compute $h_{j+1,j} = \|w\|_2$ and $v_{j+1} = w/h_{j+1,j}$
 10. Define $Z_m := [z_1, \dots, z_m]$, $\bar{H}_m = \{h_{i,j}\}_{1 \leq i \leq j+1; 1 \leq j \leq m}$
 11. EndDo
 12. Compute $y_m = \operatorname{argmin}_y \|\beta e_1 - \bar{H}_m y\|_2$, and $x_m = x_0 + Z_m y_m$.
 13. If satisfied Stop, else set $x_0 \leftarrow x_m$ and GoTo 1.
-

As can be seen, the main difference with the right preconditioned version, Algorithm 9.5, is that the preconditioned vectors $z_j = M_j^{-1}v_j$ must be saved and the solution updated using these vectors. It is clear that when $M_j = M$ for $j = 1, \dots, m$, then this method is equivalent mathematically to Algorithm 9.5. It is important to observe that z_j can be defined in line 3 without reference to any preconditioner. That is, any given new vector z_j can be chosen. This added flexibility may cause the algorithm some problems. Indeed, z_j may be so poorly selected that a breakdown could occur, as in the worst-case scenario when z_j is zero.

One difference between FGMRES and the usual GMRES algorithm is that the action of AM_j^{-1} on a vector v of the Krylov subspace is no longer in the span of V_{m+1} . Instead, it is easy to show that

$$AZ_m = V_{m+1}\bar{H}_m \quad (9.21)$$

in replacement of the simpler relation $(AM^{-1})V_m = V_{m+1}\bar{H}_m$ which holds for the standard preconditioned GMRES; see (6.5). As before, H_m denotes the $m \times m$ matrix obtained from \bar{H}_m by deleting its last row and \hat{v}_{j+1} is the vector w which is normalized in line 9 of Algorithm 9.6 to obtain v_{j+1} . Then, the following alternative formulation of (9.21) is valid, even when $h_{m+1,m} = 0$:

$$AZ_m = V_m H_m + \hat{v}_{m+1} e_m^T. \quad (9.22)$$

An optimality property similar to the one which defines GMRES can be proved. Consider the residual vector for an arbitrary vector $z = x_0 + Z_m y$ in the affine space $x_0 + \operatorname{span}\{Z_m\}$. This optimality property is based on the relations

$$\begin{aligned} b - Az &= b - A(x_0 + Z_m y) \\ &= r_0 - AZ_m y \end{aligned} \quad (9.23)$$

$$\begin{aligned}
&= \beta v_1 - V_{m+1} \bar{H}_m y \\
&= V_{m+1} [\beta e_1 - \bar{H}_m y].
\end{aligned} \tag{9.24}$$

If $J_m(y)$ denotes the function

$$J_m(y) = \|b - A[x_0 + Z_m y]\|_2,$$

observe that by (9.24) and the fact that V_{m+1} is unitary,

$$J_m(y) = \|\beta e_1 - \bar{H}_m y\|_2. \tag{9.25}$$

Since the algorithm minimizes this norm over all vectors u in \mathbb{R}^m to yield y_m , it is clear that the approximate solution $x_m = x_0 + Z_m y_m$ has the smallest residual norm in $x_0 + \text{Span}\{Z_m\}$. Thus, the following result is proved.

PROPOSITION 9.2 *The approximate solution x_m obtained at step m of FGMRES minimizes the residual norm $\|b - Ax_m\|_2$ over $x_0 + \text{Span}\{Z_m\}$.*

Next, consider the possibility of breakdown in FGMRES. A breakdown occurs when the vector v_{j+1} cannot be computed in line 9 of Algorithm 9.6 because $h_{j+1,j} = 0$. For the standard GMRES algorithm, this is not a problem because when this happens then the approximate solution x_j is exact. The situation for FGMRES is slightly different.

PROPOSITION 9.3 *Assume that $\beta = \|r_0\|_2 \neq 0$ and that $j - 1$ steps of FGMRES have been successfully performed, i.e., that $h_{i+1,i} \neq 0$ for $i < j$. In addition, assume that the matrix H_j is nonsingular. Then x_j is exact, if and only if $h_{j+1,j} = 0$.*

Proof. If $h_{j+1,j} = 0$, then $AZ_j = V_j H_j$, and as a result

$$J_j(y) = \|\beta v_1 - AZ_j y\|_2 = \|\beta v_1 - V_j H_j y\|_2 = \|\beta e_1 - H_j y\|_2.$$

If H_j is nonsingular, then the above function is minimized for $y_j = H_j^{-1}(\beta e_1)$ and the corresponding minimum norm reached is zero, i.e., x_j is exact.

Conversely, if x_j is exact, then from (9.22) and (9.23),

$$0 = b - Ax_j = V_j [\beta e_1 - H_j y_j] + \hat{v}_{j+1} e_j^T y_j. \tag{9.26}$$

We must show, by contraction, that $\hat{v}_{j+1} = 0$. Assume that $\hat{v}_{j+1} \neq 0$. Since $\hat{v}_{j+1}, v_1, v_2, \dots, v_m$, form an orthogonal system, then it follows from (9.26) that $\beta e_1 - H_j y_j = 0$ and $e_j^T y_j = 0$. The last component of y_j is equal to zero. A simple back-substitution for the system $H_j y_j = \beta e_1$, starting from the last equation, will show that all components of y_j are zero. Because H_m is nonsingular, this would imply that $\beta = 0$ and contradict the assumption. ■

The only difference between this result and that of Proposition 6.10 for the GMRES algorithm is that the additional assumption must be made that H_j is nonsingular since it is no longer implied by the nonsingularity of A . However, H_m is guaranteed to be nonsingular when all the z_j 's are linearly independent and A is nonsingular. This is a consequence of a modification of the first part of Proposition 6.9. That same proof shows that the rank of AZ_m is equal to the rank of the matrix R_m therein. If R_m is nonsingular and $h_{m+1,m} = 0$, then H_m is also nonsingular.

A consequence of the above proposition is that if $Az_j = v_j$, at a certain step, i.e., if the preconditioning is “exact,” then the approximation x_j will be exact provided that H_j is nonsingular. This is because $w = Az_j$ would depend linearly on the previous v_i ’s (it is equal to v_j), and as a result the orthogonalization process would yield $\hat{v}_{j+1} = 0$.

A difficulty with the theory of the new algorithm is that general convergence results, such as those seen in earlier chapters, cannot be proved. That is because the subspace of approximants is no longer a standard Krylov subspace. However, the optimality property of Proposition 9.2 can be exploited in some specific situations. For example, if within each outer iteration *at least one* of the vectors z_j is chosen to be a steepest descent direction vector, e.g., for the function $F(x) = \|b - Ax\|_2^2$, then FGMRES is guaranteed to converge independently of m .

The additional cost of the flexible variant over the standard algorithm is only in the extra memory required to save the set of vectors $\{z_j\}_{j=1,\dots,m}$. Yet, the added advantage of *flexibility* may be worth this extra cost. A few applications can benefit from this flexibility, especially in developing robust iterative methods or preconditioners on parallel computers. Thus, *any* iterative technique can be used as a preconditioner: block-SOR, SSOR, ADI, Multi-grid, etc. More interestingly, iterative procedures such as GMRES, CGNR, or CGS can also be used as preconditioners. Also, it may be useful to mix two or more preconditioners to solve a given problem. For example, two types of preconditioners can be applied alternatively at each FGMRES step to mix the effects of “local” and “global” couplings in the PDE context.

9.4.2 DQGMRES

Recall that the DQGMRES algorithm presented in Chapter 6 uses an incomplete orthogonalization process instead of the full Arnoldi orthogonalization. At each step, the current vector is orthogonalized only against the k previous ones. The vectors thus generated are “locally” orthogonal to each other, in that $(v_i, v_j) = \delta_{ij}$ for $|i - j| < k$. The matrix \bar{H}_m becomes banded and upper Hessenberg. Therefore, the approximate solution can be updated at step j from the approximate solution at step $j - 1$ via the recurrence

$$p_j = \frac{1}{r_{jj}}, \left[v_j - \sum_{i=j-k+1}^{j-1} r_{ij} p_i \right], \quad x_j = x_{j-1} + \gamma_j p_j \quad (9.27)$$

in which the scalars γ_j and r_{ij} are obtained recursively from the Hessenberg matrix \bar{H}_j .

An advantage of DQGMRES is that it is also *flexible*. The principle is the same as in FGMRES. In both cases the vectors $z_j = M_j^{-1}v_j$ must be computed. In the case of FGMRES, these vectors must be saved and this requires extra storage. For DQGMRES, it can be observed that the preconditioned vectors z_j only affect the update of the vector p_j in the preconditioned version of the update formula (9.27), yielding

$$p_j = \frac{1}{r_{jj}} \left[M_j^{-1}v_j - \sum_{i=j-k+1}^{j-1} r_{ij} p_i \right].$$

As a result, $M_j^{-1}v_j$ can be discarded immediately after it is used to update p_j . The same

memory locations can store this vector and the vector p_j . This contrasts with FGMRES which requires additional vectors of storage.

PRECONDITIONED CG FOR THE NORMAL EQUATIONS

9.5

There are several versions of the preconditioned Conjugate Gradient method applied to the normal equations. Two versions come from the NR/NE options, and three other variations from the right, left, or split preconditioning options. Here, we consider only the left preconditioned variants.

The left preconditioned CGNR algorithm is easily derived from Algorithm 9.1. Denote by r_j the residual for the original system, i.e., $r_j = b - Ax_j$, and by $\tilde{r}_j = A^T r_j$ the residual for the normal equations system. The preconditioned residual z_j is $z_j = M^{-1}\tilde{r}_j$. The scalar α_j in Algorithm 9.1 is now given by

$$\alpha_j = \frac{(\tilde{r}_j, z_j)}{(A^T A p_j, p_j)} = \frac{(\tilde{r}_j, z_j)}{(A p_j, A p_j)}.$$

This suggests employing the auxiliary vector $w_j = A p_j$ in the algorithm which takes the following form.

ALGORITHM 9.7: Left-Preconditioned CGNR

1. Compute $r_0 = b - Ax_0$, $\tilde{r}_0 = A^T r_0$, $z_0 = M^{-1}\tilde{r}_0$, $p_0 = z_0$.
 2. For $j = 0, \dots$, until convergence Do:
 3. $w_j = A p_j$
 4. $\alpha_j = (z_j, \tilde{r}_j) / \|w_j\|_2^2$
 5. $x_{j+1} = x_j + \alpha_j p_j$
 6. $r_{j+1} = r_j - \alpha_j w_j$
 7. $\tilde{r}_{j+1} = A^T r_{j+1}$
 8. $z_{j+1} = M^{-1}\tilde{r}_{j+1}$
 9. $\beta_j = (z_{j+1}, \tilde{r}_{j+1}) / (z_j, \tilde{r}_j)$
 10. $p_{j+1} = z_{j+1} + \beta_j p_j$
 11. EndDo
-

Similarly, the linear system $AA^T u = b$, with $x = A^T u$, can also be preconditioned from the left, and solved with the preconditioned Conjugate Gradient algorithm. Here, it is observed that the update of the u variable, the associated x variable, and two residuals take the form

$$\begin{aligned} \alpha_j &= \frac{(r_j, z_j)}{(AA^T p_j, p_j)} = \frac{(r_j, z_j)}{(A^T p_j, A^T p_j)} \\ u_{j+1} &= u_j + \alpha_j p_j \quad \leftrightarrow \quad x_{j+1} = x_j + \alpha_j A^T p_j \\ r_{j+1} &= r_j - \alpha_j AA^T p_j \\ z_{j+1} &= M^{-1} r_{j+1} \end{aligned}$$

Thus, if the algorithm for the unknown x is to be written, then the vectors $A^T p_j$ can be used instead of the vectors p_j , which are not needed. To update these vectors at the end of the algorithm the relation $p_{j+1} = z_{j+1} + \beta_{j+1} p_j$ in line 8 of Algorithm 9.1 must be multiplied through by A^T . This leads to the left preconditioned version of CGNE, in which the notation has been changed to denote by p_j the vector $A^T p_j$ invoked in the above derivation.

ALGORITHM 9.8: Left-Preconditioned CGNE

1. Compute $r_0 = b - Ax_0$, $z_0 = M^{-1}r_0$, $p_0 = A^T z_0$.
 2. For $j = 0, 1, \dots$, until convergence Do:
 3. $w_j = Ap_j$
 4. $\alpha_j = (z_j, r_j) / (p_j, p_j)$
 5. $x_{j+1} = x_j + \alpha_j p_j$
 6. $r_{j+1} = r_j - \alpha_j w_j$
 7. $z_{j+1} = M^{-1}r_{j+1}$
 8. $\beta_j = (z_{j+1}, r_{j+1}) / (z_j, r_j)$
 9. $p_{j+1} = A^T z_{j+1} + \beta_j p_j$
 10. EndDo
-

Not shown here are the right and split preconditioned versions which are considered in Exercise 3.

THE CGW ALGORITHM

9.6

When the matrix is nearly symmetric, we can think of preconditioning the system with the symmetric part of A . This gives rise to a few variants of a method known as the CGW method, from the names of the three authors Concus and Golub [60], and Widlund [225] who proposed this technique in the middle of the 1970s. Originally, the algorithm was not viewed from the angle of preconditioning. Writing $A = M - N$, with $M = \frac{1}{2}(A + A^H)$, the authors observed that the preconditioned matrix

$$M^{-1}A = I - M^{-1}N$$

is equal to the identity matrix, plus a matrix which is skew-Hermitian with respect to the M -inner product. It is not too difficult to show that the tridiagonal matrix corresponding to the Lanczos algorithm, applied to A with the M -inner product, has the form

$$T_m = \begin{pmatrix} 1 & -\beta_2 & & & \\ \beta_2 & 1 & -\beta_3 & & \\ & \cdot & \cdot & \cdot & \\ & & \beta_{m-1} & 1 & -\beta_m \\ & & & \beta_m & 1 \end{pmatrix}. \quad (9.28)$$

As a result, a three-term recurrence in the Arnoldi process is obtained, which results in a solution algorithm that resembles the standard preconditioned CG algorithm (Algorithm 9.1).

A version of the algorithm can be derived easily. From the developments in Section 6.7 relating the Lanczos algorithm to the Conjugate Gradient algorithm, it is known that x_{j+1} can be expressed as

$$x_{j+1} = x_j + \alpha_j p_j.$$

The preconditioned residual vectors must then satisfy the recurrence

$$z_{j+1} = z_j - \alpha_j M^{-1} A p_j$$

and if the z_j 's are to be M -orthogonal, then we must have $(z_j - \alpha_j M^{-1} A p_j, z_j)_M = 0$. As a result,

$$\alpha_j = \frac{(z_j, z_j)_M}{(M^{-1} A p_j, z_j)_M} = \frac{(r_j, z_j)}{(A p_j, z_j)}.$$

Also, the next search direction p_{j+1} is a linear combination of z_{j+1} and p_j ,

$$p_{j+1} = z_{j+1} + \beta_j p_j.$$

Thus, a first consequence is that

$$(A p_j, z_j)_M = (M^{-1} A p_j, p_j - \beta_{j-1} p_{j-1})_M = (M^{-1} A p_j, p_j)_M = (A p_j, p_j)$$

because $M^{-1} A p_j$ is orthogonal to all vectors in \mathcal{K}_{j-1} . In addition, writing that p_{j+1} is M -orthogonal to $M^{-1} A p_j$ yields

$$\beta_j = -\frac{(z_{j+1}, M^{-1} A p_j)_M}{(p_j, M^{-1} A p_j)_M}.$$

Note that $M^{-1} A p_j = -\frac{1}{\alpha_j}(z_{j+1} - z_j)$ and therefore we have, just as in the standard PCG algorithm,

$$\beta_j = \frac{(z_{j+1}, z_{j+1})_M}{(z_j, z_j)_M} = \frac{(z_{j+1}, r_{j+1})}{(z_j, r_j)}.$$

EXERCISES

1. Let a matrix A and its preconditioner M be SPD. Observing that $M^{-1}A$ is self-adjoint with respect to the A inner-product, write an algorithm similar to Algorithm 9.1 for solving the preconditioned linear system $M^{-1}Ax = M^{-1}b$, using the A -inner product. The algorithm should employ only one matrix-by-vector product per CG step.
2. In Section 9.2.1, the split-preconditioned Conjugate Gradient algorithm, Algorithm 9.2, was derived from the Preconditioned Conjugate Gradient Algorithm 9.1. The opposite can also be done. Derive Algorithm 9.1 starting from Algorithm 9.2, providing a different proof of the equivalence of the two algorithms.

3. Six versions of the CG algorithm applied to the normal equations can be defined. Two versions come from the NR/NE options, each of which can be preconditioned from left, right, or on two sides. The left preconditioned variants have been given in Section 9.5. Describe the four other versions: Right P-CGMR, Right P-CGNE, Split P-CGMR, Split P-CGNE. Suitable inner products may be used to preserve symmetry.
4. When preconditioning the normal equations, whether the NE or NR form, two options are available in addition to the left, right and split preconditioners. These are “centered” versions:

$$AM^{-1}A^T u = b, \quad x = M^{-1}A^T u$$

for the NE form, and

$$A^T M^{-1} Ax = A^T M^{-1} b$$

for the NR form. The coefficient matrices in the above systems are all symmetric. Write down the adapted versions of the CG algorithm for these options.

5. Let a matrix A and its preconditioner M be SPD. The standard result about the rate of convergence of the CG algorithm is not valid for the Preconditioned Conjugate Gradient algorithm, Algorithm 9.1. Show how to adapt this result by exploiting the M -inner product. Show how to derive the same result by using the equivalence between Algorithm 9.1 and Algorithm 9.2.
6. In Eisenstat’s implementation of the PCG algorithm, the operation with the diagonal D causes some difficulties when describing the algorithm. This can be avoided.
 - a. Assume that the diagonal D of the preconditioning (9.5) is equal to the identity matrix. What are the number of operations needed to perform one step of the PCG algorithm with Eisenstat’s implementation? Formulate the PCG scheme for this case carefully.
 - b. The rows and columns of the preconditioning matrix M can be scaled so that the matrix D of the transformed preconditioner, written in the form (9.5), is equal to the identity matrix. What scaling should be used (the resulting M should also be SPD)?
 - c. Assume that the same scaling of question b is also applied to the original matrix A . Is the resulting iteration mathematically equivalent to using Algorithm 9.1 to solve the system (9.6) preconditioned with the diagonal D ?
7. In order to save operations, the two matrices $D^{-1}E$ and $D^{-1}E^T$ must be stored when computing $\hat{A}v$ by Algorithm 9.3. This exercise considers alternatives.
 - a. Consider the matrix $B \equiv D\hat{A}D$. Show how to implement an algorithm similar to 9.3 for multiplying a vector v by B . The requirement is that only ED^{-1} must be stored.
 - b. The matrix B in the previous question is not the proper preconditioned version of A by the preconditioning (9.5). CG is used on an equivalent system involving B but a further preconditioning by a diagonal must be applied. Which one? How does the resulting algorithm compare in terms of cost and storage with an Algorithm based on 9.3?
 - c. It was mentioned in Section 9.2.2 that \hat{A} needed to be further preconditioned by D^{-1} . Consider the split-preconditioning option: CG is to be applied to the preconditioned system associated with $C = D^{1/2}\hat{A}D^{1/2}$. Defining $\hat{E} = D^{-1/2}ED^{-1/2}$ show that,

$$C = (I - \hat{E})^{-1}D_2(I - \hat{E})^{-T} + (I - \hat{E})^{-1} + (I - \hat{E})^{-T}$$
 where D_2 is a certain matrix to be determined. Then write an analogue of Algorithm 9.3 using this formulation. How does the operation count compare with that of Algorithm 9.3?
8. Assume that the number of nonzero elements of a matrix A is parameterized by $Nz(Z) = \alpha n$. How small should α be before it does not pay to use Eisenstat’s implementation for the PCG algorithm? What if the matrix A is initially scaled so that D is the identity matrix?

9. Let $M = LU$ be a preconditioner for a matrix A . Show that the left, right, and split preconditioned matrices all have the same eigenvalues. Does this mean that the corresponding preconditioned iterations will converge in (a) exactly the same number of steps? (b) roughly the same number of steps for any matrix? (c) roughly the same number of steps, except for ill-conditioned matrices?
10. Show that the relation (9.17) holds for any polynomial s and any vector r .
11. Write the equivalent of Algorithm 9.1 for the Conjugate Residual method.
12. Assume that a Symmetric Positive Definite matrix M is used to precondition GMRES for solving a nonsymmetric linear system. The main features of the P-GMRES algorithm exploiting this were given in Section 9.2.1. Give a formal description of the algorithm. In particular give a Modified Gram-Schmidt implementation. [Hint: The vectors Mv_i 's must be saved in addition to the v_i 's.] What optimality property does the approximate solution satisfy? What happens if the original matrix A is also symmetric? What is a potential advantage of the resulting algorithm?

NOTES AND REFERENCES. The preconditioned version of CG described in Algorithm 9.1 is due to Meijerink and van der Vorst [149]. Eisenstat's implementation was developed in [80] and is often referred to as *Eisenstat's trick*. A number of other similar ideas are described in [153]. Several flexible variants of nonsymmetric Krylov subspace methods have been developed by several authors simultaneously; see, e.g., [18], [181], and [211]. There does not seem to exist a similar technique for left preconditioned variants of the Krylov subspace methods. This is because the preconditioned operator $M_j^{-1}A$ now changes at each step. Similarly, no flexible variants have been developed for the BCG-based methods, because the short recurrences of these algorithms rely on the preconditioned operator being constant.

The CGW algorithm can be useful in some instances, such as when the symmetric part of A can be inverted easily, e.g., using fast Poisson solvers. Otherwise, its weakness is that linear systems with the symmetric part must be solved exactly. Inner-outer variations that do not require exact solutions have been described by Golub and Overton [109]. ■

PRECONDITIONING TECHNIQUES

Finding a good preconditioner to solve a given sparse linear system is often viewed as a combination of art and science. Theoretical results are rare and some methods work surprisingly well, often despite expectations. A preconditioner can be defined as any subsidiary approximate solver which is combined with an outer iteration technique, typically one of the Krylov subspace iterations seen in previous chapters. This chapter covers some of the most successful techniques used to precondition a general sparse linear system. Note at the outset that there are virtually no limits to available options for obtaining good preconditioners. For example, preconditioners can be derived from knowledge of the original physical problems from which the linear system arises. However, a common feature of the preconditioners discussed in this chapter is that they are built from the original coefficient matrix.

INTRODUCTION

10.1

Roughly speaking, a preconditioner is any form of implicit or explicit modification of an original linear system which makes it “easier” to solve by a given iterative method. For example, scaling all rows of a linear system to make the diagonal elements equal to one is an explicit form of preconditioning. The resulting system can be solved by a Krylov subspace method and may require fewer steps to converge than with the original system (although this is not guaranteed). As another example, solving the linear system

$$M^{-1}Ax = M^{-1}b$$

where M^{-1} is some complicated mapping that may involve FFT transforms, integral calculations, and subsidiary linear system solutions, may be another form of preconditioning. Here, it is unlikely that the matrix M and $M^{-1}A$ can be computed explicitly. Instead,

the iterative processes operate with A and with M^{-1} whenever needed. In practice, the preconditioning operation M^{-1} should be inexpensive to apply to an arbitrary vector.

One of the simplest ways of defining a preconditioner is to perform an *incomplete factorization* of the original matrix A . This entails a decomposition of the form $A = LU - R$ where L and U have the same nonzero structure as the lower and upper parts of A respectively, and R is the *residual* or *error* of the factorization. This incomplete factorization known as ILU(0) is rather easy and inexpensive to compute. On the other hand, it often leads to a crude approximation which may result in the Krylov subspace accelerator requiring many iterations to converge. To remedy this, several alternative incomplete factorizations have been developed by allowing more fill-in in L and U . In general, the more accurate ILU factorizations require fewer iterations to converge, but the preprocessing cost to compute the factors is higher. However, if only because of the improved robustness, these trade-offs generally favor the more accurate factorizations. This is especially true when several systems with the same matrix must be solved because the preprocessing cost can be amortized.

This chapter considers the most common preconditioners used for solving large sparse matrices and compares their performance. It begins with the simplest preconditioners (SOR and SSOR) and then discusses the more accurate variants such as ILUT.

JACOBI, SOR, AND SSOR PRECONDITIONERS

10.2

As was seen in Chapter 4, a fixed-point iteration for solving a linear system

$$Ax = b$$

takes the general form

$$x_{k+1} = M^{-1}Nx_k + M^{-1}b \quad (10.1)$$

where M and N realize the splitting of A into

$$A = M - N. \quad (10.2)$$

The above iteration is of the form

$$x_{k+1} = Gx_k + f \quad (10.3)$$

where $f = M^{-1}b$ and

$$\begin{aligned} G &= M^{-1}N = M^{-1}(M - A) \\ &= I - M^{-1}A. \end{aligned} \quad (10.4)$$

Thus, for Jacobi and Gauss Seidel it has been shown that

$$G_{JA}(A) = I - D^{-1}A \quad (10.5)$$

$$G_{GS}(A) = I - (D - E)^{-1}A, \quad (10.6)$$

where $A = D - E - F$ is the splitting defined in Chapter 4.

The iteration (10.3) is attempting to solve

$$(I - G)x = f \quad (10.7)$$

which, because of the expression (10.4) for G , can be rewritten as

$$M^{-1}Ax = M^{-1}b. \quad (10.8)$$

The above system is the *preconditioned system* associated with the splitting $A = M - N$, and the iteration (10.3) is nothing but a *fixed-point iteration on this preconditioned system*. Similarly, a Krylov subspace method, e.g., GMRES, can be used to solve (10.8), leading to a preconditioned version of the Krylov subspace method, e.g., preconditioned GMRES. The preconditioned versions of some Krylov subspace methods have been discussed in the previous chapter with a generic preconditioner M . In theory, any general splitting in which M is nonsingular can be used. Ideally, M should be close to A in some sense. However, note that a linear system with the matrix M must be solved at each step of the iterative procedure. Therefore, a practical and admittedly somewhat vague requirement is that these solutions steps should be inexpensive.

As was seen in Chapter 4, the SSOR preconditioner is defined by

$$M_{SSOR} = (D - \omega E)D^{-1}(D - \omega F).$$

Typically, when this matrix is used as a preconditioner, it is not necessary to choose ω as carefully as for the underlying fixed-point iteration. Taking $\omega = 1$ leads to the Symmetric Gauss-Seidel (SGS) iteration,

$$M_{SGS} = (D - E)D^{-1}(D - F). \quad (10.9)$$

An interesting observation is that $D - E$ is the lower part of A , including the diagonal, and $D - F$ is, similarly, the upper part of A . Thus,

$$M_{SGS} = LU,$$

with

$$L \equiv (D - E)D^{-1} = I - ED^{-1}, \quad U = D - F.$$

The matrix L is unit lower triangular and U is upper triangular. One question that may arise concerns the implementation of the preconditioning operation. To compute $w = M_{SGS}^{-1}x$, proceed as follows:

$$\text{solve } (I - ED^{-1})z = x,$$

$$\text{solve } (D - F)w = z.$$

A FORTRAN implementation of this preconditioning operation is illustrated in the following code, for matrices stored in the MSR format described in Chapter 3.

FORTRAN CODE

```

subroutine lusol (n,rhs,sol,luval,lucol,luptr,uptr)
  real*8 sol(n), rhs(n), luval(*)
  integer n, luptr(*), uptr(n)
c-----
c Performs a forward and a backward solve for an ILU or
c SSOR factorization, i.e., solves (LU) sol = rhs where LU
c is the ILU or the SSOR factorization. For SSOR, L and U

```

```

c should contain the matrices L = I - omega E inv(D), and U
c = D - omega F, respectively with -E = strict lower
c triangular part of A, -F = strict upper triangular part
c of A, and D = diagonal of A.
c-----
c PARAMETERS:
c n      = Dimension of problem
c rhs    = Right hand side; rhs is unchanged on return
c sol    = Solution of (LU) sol = rhs.
c luval  = Values of the LU matrix. L and U are stored
c         together in CSR format. The diagonal elements of
c         U are inverted. In each row, the L values are
c         followed by the diagonal element (inverted) and
c         then the other U values.
c lucol  = Column indices of corresponding elements in luval
c luptr  = Contains pointers to the beginning of each row in
c         the LU matrix.
c uptr   = pointer to the diagonal elements in luval, lucol
c-----
      integer i,k
c
c FORWARD SOLVE. Solve L . sol = rhs
c
      do i = 1, n
c
c compute sol(i) := rhs(i) - sum L(i,j) x sol(j)
c
          sol(i) = rhs(i)
          do k=luptr(i),uptr(i)-1
              sol(i) = sol(i) - luval(k)* sol(lucol(k))
          enddo
      enddo
c
c BACKWARD SOLVE. Compute sol := inv(U) sol
c
      do i = n, 1, -1
c
c compute sol(i) := sol(i) - sum U(i,j) x sol(j)
c
          do k=uptr(i)+1, luptr(i+1)-1
              sol(i) = sol(i) - luval(k)*sol(lucol(k))
          enddo
c
c compute sol(i) := sol(i)/ U(i,i)
c
          sol(i) = luval(uptr(i))*sol(i)
      enddo
      return
      end

```

As was seen above, the SSOR or SGS preconditioning matrix is of the form $M = LU$ where L and U have the same pattern as the L -part and the U -part of A , respectively. Here, L -part means lower triangular part and, similarly, the U -part is the upper triangular part. If the error matrix $A - LU$ is computed, then for SGS, for example, we would find

$$A - LU = D - E - F - (I - ED^{-1})(D - F) = -ED^{-1}F.$$

If L is restricted to have the same structure as the L -part of A and U is to have the same

structure as the U -part of A , the question is whether or not it is possible to find L and U that yield an error that is smaller in some sense than the one above. We can, for example, try to find such an incomplete factorization in which the residual matrix $A - LU$ has zero elements in locations where A has nonzero entries. This turns out to be possible in general and yields the ILU(0) factorization to be discussed later. Generally, a pattern for L and U can be specified and L and U may be sought so that they satisfy certain conditions. This leads to the general class of incomplete factorization techniques which are discussed in the next section.

Example 10.1 Table 10.1 shows the results of applying the GMRES algorithm with SGS (SSOR with $\omega = 1$) preconditioning to the five test problems described in Section 3.7.

Matrix	Iters	Kflops	Residual	Error
F2DA	38	1986	0.76E-03	0.82E-04
F3D	20	4870	0.14E-02	0.30E-03
ORS	110	6755	0.31E+00	0.68E-04
F2DB	300	15907	0.23E+02	0.66E+00
FID	300	99070	0.26E+02	0.51E-01

Table 10.1 A test run of GMRES with SGS preconditioning.

See Example 6.1 for the meaning of the column headers in the table. Notice here that the method did not converge in 300 steps for the last two problems. The number of iterations for the first three problems is reduced substantially from those required by GMRES without preconditioning shown in Table 6.2. The total number of operations required is also reduced, but not proportionally because each step now costs more due to the preconditioning operation.

ILU FACTORIZATION PRECONDITIONERS

10.3

Consider a general sparse matrix A whose elements are $a_{ij}, i, j = 1, \dots, n$. A general Incomplete LU (ILU) factorization process computes a sparse lower triangular matrix L and a sparse upper triangular matrix U so the residual matrix $R = LU - A$ satisfies certain constraints, such as having zero entries in some locations. We first describe a general ILU preconditioner geared toward M -matrices. Then we discuss the ILU(0) factorization, the simplest form of the ILU preconditioners. Finally, we will show how to obtain more accurate factorizations.

10.3.1 INCOMPLETE LU FACTORIZATIONS

A general algorithm for building Incomplete LU factorizations can be derived by performing Gaussian elimination and dropping some elements in predetermined nondiagonal positions. To analyze this process and establish existence for M -matrices, the following result of Ky-Fan [86] is needed.

THEOREM 10.1 *Let A be an M -matrix and let A_1 be the matrix obtained from the first step of Gaussian elimination. Then A_1 is an M -matrix.*

Proof. Theorem 1.17 will be used to establish that properties 1, 2, and 3 therein are satisfied. First, consider the off-diagonal elements of A_1 :

$$a_{ij}^1 = a_{ij} - \frac{a_{i1}a_{1j}}{a_{11}}.$$

Since a_{ij}, a_{i1}, a_{1j} are nonpositive and a_{11} is positive, it follows that $a_{ij}^1 \leq 0$ for $i \neq j$.

Second, the fact that A_1 is nonsingular is a trivial consequence of the following standard relation of Gaussian elimination

$$A = L_1 A_1 \quad \text{where} \quad L_1 = \left[\begin{array}{c} A_{*,1} \\ \frac{1}{a_{11}} \end{array}, e_2, e_3, \dots, e_n \right]. \quad (10.10)$$

Finally, we establish that A_1^{-1} is nonnegative by examining $A_1^{-1}e_j$ for $j = 1, \dots, n$. For $j = 1$, it is clear that $A_1^{-1}e_1 = \frac{1}{a_{11}}e_1$ because of the structure of A_1 . For the case $j \neq 1$, (10.10) can be exploited to yield

$$A_1^{-1}e_j = A^{-1}L_1^{-1}e_j = A^{-1}e_j \geq 0.$$

Therefore, all the columns of A_1^{-1} are nonnegative by assumption and this completes the proof. ■

Clearly, the $(n-1) \times (n-1)$ matrix obtained from A_1 by removing its first row and first column is also an M -matrix.

Assume now that some elements are dropped from the result of Gaussian Elimination outside of the main diagonal. Any element that is dropped is a nonpositive element which is transformed into a zero. Therefore, the resulting matrix \tilde{A}_1 is such that

$$\tilde{A}_1 = A_1 + R,$$

where the elements of R are such that $r_{ii} = 0, r_{ij} \geq 0$. Thus,

$$A_1 \leq \tilde{A}_1$$

and the off-diagonal elements of \tilde{A}_1 are nonpositive. Since A_1 is an M -matrix, theorem 1.18 shows that \tilde{A}_1 is also an M -matrix. The process can now be repeated on the matrix $\tilde{A}(2:n, 2:n)$, and then continued until the incomplete factorization of A is obtained. The above arguments shows that at each step of this construction, we obtain an M -matrix and that the process does not break down.

The elements to drop at each step have not yet been specified. This can be done statically, by choosing some non-zero pattern in advance. The only restriction on the zero pattern is that it should exclude diagonal elements because this assumption was used in the

above proof. Therefore, for any zero pattern set P , such that

$$P \subset \{(i, j) \mid i \neq j; 1 \leq i, j \leq n\}, \quad (10.11)$$

an Incomplete LU factorization, $ILLU_P$, can be computed as follows.

ALGORITHM 10.1: General Static Pattern ILU

1. For $k = 1, \dots, n - 1$ Do:
 2. For $i = k + 1, n$ and if $(i, k) \notin P$ Do:
 3. $a_{ik} := a_{ik}/a_{kk}$
 4. For $j = k + 1, \dots, n$ and for $(i, j) \notin P$ Do:
 5. $a_{ij} := a_{ij} - a_{ik} * a_{kj}$
 6. EndDo
 7. EndDo
 8. EndDo
-

The For loop in line 4 should be interpreted as follows: For $j = k + 1, \dots, n$ and only for those indices j that are not in P execute the next line. In practice, it is wasteful to scan j from $k + 1$ to n because there is an inexpensive mechanism for identifying those in this set that are in the complement of P .

Using the above arguments, the following result can be proved.

THEOREM 10.2 Let A be an M -matrix and P a given zero pattern defined as in (10.11). Then Algorithm 10.1 is feasible and produces an incomplete factorization,

$$A = LU - R \quad (10.12)$$

which is a regular splitting of A .

Proof. At each step of the process, we have

$$\tilde{A}_k = A_k + R_k, \quad A_k = L_k \tilde{A}_{k-1}$$

where, using O_k to denote a zero vector of dimension k , and $A_{m:n,j}$ to denote the vector of components $a_{i,j}, i = m, \dots, n$,

$$L_k = I - \frac{1}{a_{kk}^{(k)}} \begin{pmatrix} O_k \\ A(k+1:n, k) \end{pmatrix} e_k^T.$$

From this follow the relations

$$\tilde{A}_k = A_k + R_k = L_k \tilde{A}_{k-1} + R_k.$$

Applying this relation recursively, starting from $k = n - 1$ up to $k = 1$, it is found that

$$\tilde{A}_{n-1} = L_{n-1} \dots L_1 A + L_{n-1} \dots L_2 R_1 + \dots + L_{n-1} R_{n-2} + R_{n-1}. \quad (10.13)$$

Now define

$$L = (L_{n-1} \dots L_1)^{-1}, \quad U = \tilde{A}_{n-1}.$$

Then,

$$U = L^{-1}A + S$$

with

$$S = L_{n-1} \dots L_2 R_1 + \dots + L_{n-1} R_{n-2} + R_{n-1}.$$

Observe that at stage k , elements are dropped only in the $(n - k) \times (n - k)$ lower part of A_k . Hence, the first k rows and columns of R_k are zero and as a result

$$L_{n-1} \dots L_{k+1} R_k = L_{n-1} \dots L_1 R_k$$

so that S can be rewritten as

$$S = L_{n-1} \dots L_2 (R_1 + R_2 + \dots + R_{n-1}).$$

If R denotes the matrix

$$R = R_1 + R_2 + \dots + R_{n-1},$$

then we obtain the factorization

$$A = LU - R,$$

where $(LU)^{-1} = U^{-1}L^{-1}$ is a nonnegative matrix, R is nonnegative. This completes the proof. ■

Now consider a few practical aspects. An ILU factorization based on the form of Algorithm 10.1 is difficult to implement because at each step k , all rows $k + 1$ to n are being modified. However, ILU factorizations depend on the implementation of Gaussian elimination which is used. Several variants of Gaussian elimination are known which depend on the order of the three loops associated with the control variables i , j , and k in the algorithm. Thus, Algorithm 10.1 is derived from what is known as the k, i, j variant. In the context of Incomplete LU factorization, the variant that is most commonly used for a row-contiguous data structure is the i, k, j variant, described next for dense matrices.

ALGORITHM 10.2: Gaussian Elimination – IKJ Variant

1. For $i = 2, \dots, n$ Do:
 2. For $k = 1, \dots, i - 1$ Do:
 3. $a_{ik} := a_{ik} / a_{kk}$
 4. For $j = k + 1, \dots, n$ Do:
 5. $a_{ij} := a_{ij} - a_{ik} * a_{kj}$
 6. EndDo
 7. EndDo
 8. EndDo
-

The above algorithm is in place meaning that the i -th row of A can be overwritten by the i -th rows of the L and U matrices of the factorization (since L is unit lower triangular, its diagonal entries need not be stored). Each step i of the algorithm generates the i -th row

of L and the i -th row of U at the same time. The previous rows $1, 2, \dots, i - 1$ of L and U are accessed at step i but they are not modified. This is illustrated in Figure 10.1.

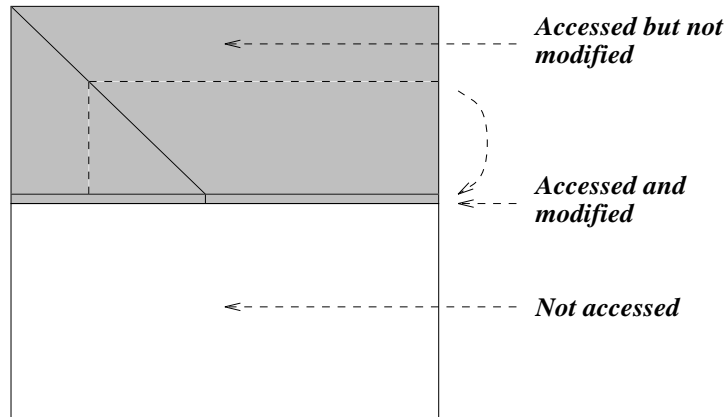

Figure 10.1 *IKJ* variant of the LU factorization.

Adapting this version for sparse matrices is easy because the rows of L and U are generated in succession. These rows can be computed one at a time and accumulated in a row-oriented data structure such as the CSR format. This constitutes an important advantage. Based on this, the general ILU factorization takes the following form.

ALGORITHM 10.3: General ILU Factorization, *IKJ* Version

1. For $i = 2, \dots, n$ Do:
 2. For $k = 1, \dots, i - 1$ and if $(i, k) \notin P$ Do:
 3. $a_{ik} := a_{ik} / a_{kk}$
 4. For $j = k + 1, \dots, n$ and for $(i, j) \notin P$, Do:
 5. $a_{ij} := a_{ij} - a_{ik} a_{kj}$.
 6. EndDo
 7. EndDo
 8. EndDo
-

It is not difficult to see that this more practical *IKJ* variant of ILU is equivalent to the *KIJ* version which can be defined from Algorithm 10.1.

PROPOSITION 10.1 *Let P be a zero pattern satisfying the condition (10.11). Then the ILU factors produced by the *KIJ*-based Algorithm 10.1 and the *IKJ*-based Algorithm 10.3 are identical if they can both be computed.*

Proof. Algorithm (10.3) is obtained from Algorithm 10.1 by switching the order of the loops k and i . To see that this gives indeed the same result, reformulate the first two loops of Algorithm 10.1 as

For $k = 1, n$ Do:
 For $i = 1, n$ Do:
 if $k < i$ and for $(i, k) \notin P$ Do:
 $ope(row(i), row(k))$

in which $ope(row(i), row(k))$ is the operation represented by lines 3 through 6 of both Algorithm 10.1 and Algorithm 10.3. In this form, it is clear that the k and i loops can be safely permuted. Then the resulting algorithm can be reformulated to yield exactly Algorithm 10.3. ■

Note that this is only true for a static pattern ILU. If the pattern is dynamically determined as the Gaussian elimination algorithm proceeds, then the patterns obtained with different versions of GE may be different.

It is helpful to interpret the result of one incomplete elimination step. Denoting by l_{i*} , u_{i*} , and a_{i*} the i -th rows of L , U , and A , respectively, then the k -loop starting at line 2 of Algorithm 10.3 can be interpreted as follows. Initially, we have $u_{i*} = a_{i*}$. Then, each elimination step is an operation of the form

$$u_{i*} := u_{i*} - l_{ik}u_{k*}.$$

However, this operation is performed only on the nonzero pattern, i.e., the complement of P . This means that, in reality, the elimination step takes the form

$$u_{i*} := u_{i*} - l_{ik}u_{k*} + r_{i*}^{(k)},$$

in which $r_{ij}^{(k)}$ is zero when $(i, j) \notin P$ and equals $l_{ik}u_{kj}$ when $(i, j) \in P$. Thus, the row $r_{i*}^{(k)}$ cancels out the terms $l_{ik}u_{kj}$ that would otherwise be introduced in the zero pattern. In the end the following relation is obtained:

$$u_{i*} = a_{i*} - \sum_{k=1}^{i-1} (l_{ik}u_{k*} - r_{i*}^{(k)}).$$

Note that $l_{ik} = 0$ for $(i, k) \in P$. We now sum up all the $r_{i*}^{(k)}$'s and define

$$r_{i*} = \sum_{k=1}^{i-1} r_{i*}^{(k)}. \quad (10.14)$$

The row r_{i*} contains the elements that fall inside the P pattern at the completion of the k -loop. Using the fact that $l_{ii} = 1$, we obtain the relation,

$$a_{i*} = \sum_{k=1}^i l_{ik}u_{k*} - r_{i*}. \quad (10.15)$$

Therefore, the following simple property can be stated.

PROPOSITION 10.2 *Algorithm (10.3) produces factors L and U such that*

$$A = LU - R$$

in which $-R$ is the matrix of the elements that are dropped during the incomplete elimination process. When $(i, j) \in P$, an entry r_{ij} of R is equal to the value of $-a_{ij}$ obtained at

the completion of the k loop in Algorithm 10.3. Otherwise, r_{ij} is zero.

10.3.2 ZERO FILL-IN ILU (ILU(0))

The *Incomplete LU* factorization technique with no fill-in, denoted by ILU(0), consists of taking the zero pattern P to be precisely the zero pattern of A . In the following, we denote by $b_{i,*}$ the i -th row of a given matrix B , and by $NZ(B)$, the set of pairs (i, j) , $1 \leq i, j \leq n$ such that $b_{i,j} \neq 0$.

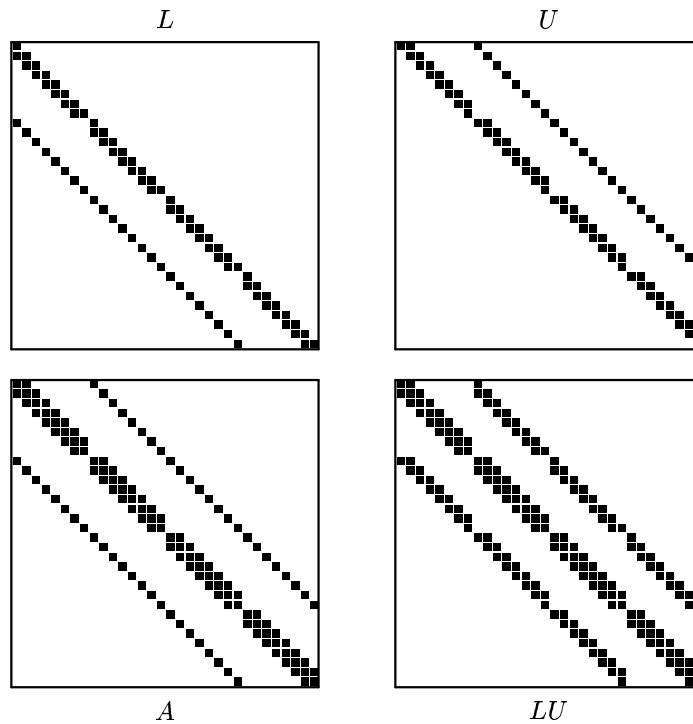

Figure 10.2 The ILU(0) factorization for a five-point matrix.

The incomplete factorization ILU(0) factorization is best illustrated by the case for which it was discovered originally, namely, for 5-point and 7-point matrices related to finite difference discretization of PDEs. Consider one such matrix A as illustrated in the bottom left corner of Figure 10.2. The A matrix represented in this figure is a 5-point matrix of size $n = 32$ corresponding to an $n_x \times n_y = 8 \times 4$ mesh. Consider now any lower triangular matrix L which has the same structure as the lower part of A , and any matrix U which has the same structure as that of the upper part of A . Two such matrices are shown at the top of Figure 10.2. If the product LU were performed, the resulting matrix would have the pattern shown in the bottom right part of the figure. It is impossible in general to match A with this product for any L and U . This is due to the extra diagonals in the product, namely, the

diagonals with offsets $n_x - 1$ and $-n_x + 1$. The entries in these extra diagonals are called *fill-in elements*. However, if these fill-in elements are ignored, then it is possible to find L and U so that their product is equal to A in the other diagonals. This defines the ILU(0) factorization in general terms: Any pair of matrices L (unit lower triangular) and U (upper triangular) so that the elements of $A - LU$ are zero in the locations of $NZ(A)$. These constraints do not define the ILU(0) factors uniquely since there are, in general, infinitely many pairs of matrices L and U which satisfy these requirements. However, the standard ILU(0) is defined constructively using Algorithm 10.3 with the pattern P equal to the zero pattern of A .

ALGORITHM 10.4: ILU(0)

1. For $i = 2, \dots, n$ Do:
 2. For $k = 1, \dots, i - 1$ and for $(i, k) \in NZ(A)$ Do:
 3. Compute $a_{ik} = a_{ik}/a_{kk}$
 4. For $j = k + 1, \dots, n$ and for $(i, j) \in NZ(A)$, Do:
 5. Compute $a_{ij} := a_{ij} - a_{ik}a_{kj}$.
 6. EndDo
 7. EndDo
 8. EndDo
-

In some cases, it is possible to write the ILU(0) factorization in the form

$$M = (D - E)D^{-1}(D - F), \quad (10.16)$$

where $-E$ and $-F$ are the strict lower and strict upper triangular parts of A , and D is a certain diagonal matrix, different from the diagonal of A , in general. In these cases it is sufficient to find a recursive formula for determining the elements in D . A clear advantage is that only an extra diagonal of storage is required. This form of the ILU(0) factorization is equivalent to the incomplete factorizations obtained from Algorithm 10.4 when the product of the *strict-lower part* and the *strict-upper part* of A consists only of diagonal elements and fill-in elements. This is true, for example, for standard 5-point difference approximations to second order partial differential operators; see Exercise 4. In these instances, both the SSOR preconditioner with $\omega = 1$ and the ILU(0) preconditioner can be cast in the form (10.16), but they differ in the way the diagonal matrix D is defined. For SSOR($\omega = 1$), D is the diagonal of the matrix A itself. For ILU(0), it is defined by a recursion so that the diagonal of the product of matrices (10.16) equals the diagonal of A . By definition, together the L and U matrices in ILU(0) have the same number of nonzero elements as the original matrix A .

Example 10.2 Table 10.2 shows the results of applying the GMRES algorithm with ILU(0) preconditioning to the five test problems described in Section 3.7.

Matrix	Iters	Kflops	Residual	Error
F2DA	28	1456	0.12E-02	0.12E-03
F3D	17	4004	0.52E-03	0.30E-03
ORS	20	1228	0.18E+00	0.67E-04
F2DB	300	15907	0.23E+02	0.67E+00
FID	206	67970	0.19E+00	0.11E-03

Table 10.2 A test run of GMRES with ILU(0) preconditioning.

See Example 6.1 for the meaning of the column headers in the table. Observe that for the first two problems, the gains compared with the performance of the SSOR preconditioner in Table 10.1 are rather small. For the other three problems, which are a little harder, the gains are more substantial. For the last problem, the algorithm achieves convergence in 205 steps whereas SSOR did not converge in the 300 steps allowed. The fourth problem (F2DB) is still not solvable by ILU(0) within the maximum number of steps allowed.

For the purpose of illustration, below is a sample FORTRAN code for computing the incomplete L and U factors for general sparse matrices stored in the usual CSR format. The real values of the resulting L, U factors are stored in the array *luval*, except that entries of ones of the main diagonal of the unit lower triangular matrix L are not stored. Thus, one matrix is needed to store these factors together. This matrix is denoted by L/U . Note that since the pattern of L/U is identical with that of A , the other integer arrays of the CSR representation for the LU factors are not needed. Thus, $ja(k)$, which is the column position of the element $a(k)$ in the input matrix, is also the column position of the element $luval(k)$ in the L/U matrix. The code below assumes that the nonzero elements in the input matrix A are sorted by increasing column numbers in each row.

FORTRAN CODE

```

subroutine ilu0 (n, a, ja, ia, luval, uptr, iw, icode)
  integer n, ja(*), ia(n+1), uptr(n), iw(n)
  real*8 a(*), luval(*)
c-----
c Set-up routine for ILU(0) preconditioner. This routine
c computes the L and U factors of the ILU(0) factorization
c of a general sparse matrix A stored in CSR format. Since
c L is unit triangular, the L and U factors can be stored
c as a single matrix which occupies the same storage as A.
c The ja and ia arrays are not needed for the LU matrix
c since the pattern of the LU matrix is identical with
c that of A.
c-----
c INPUT:
c -----
c n          = dimension of matrix
c a, ja, ia = sparse matrix in general sparse storage format
c iw        = integer work array of length n
c OUTPUT:
c -----
c luval     = L/U matrices stored together. On return luval,
c           ja, ia is the combined CSR data structure for
c           the LU factors

```

```

c uptr      = pointer to the diagonal elements in the CSR
c           data structure luval, ja, ia
c icode     = integer indicating error code on return
c           icode = 0: normal return
c           icode = k: encountered a zero pivot at step k
c
c-----
c   initialize work array iw to zero and luval array to a
do 30 i = 1, ia(n+1)-1
    luval(i) = a(i)
30  continue
do 31 i=1, n
    iw(i) = 0
31  continue
c----- Main loop
do 500 k = 1, n
    j1 = ia(k)
    j2 = ia(k+1)-1
    do 100 j=j1, j2
        iw(ja(j)) = j
100  continue
    j=j1
150  jrow = ja(j)
c----- Exit if diagonal element is reached
    if (jrow .ge. k) goto 200
c----- Compute the multiplier for jrow.
    t1 = luval(j)*luval(uptr(jrow))
    luval(j) = t1
c----- Perform linear combination
    do 140 jj = uptr(jrow)+1, ia(jrow+1)-1
        jw = iw(ja(jj))
        if (jw .ne. 0) luval(jw)=luval(jw)-t1*luval(jj)
140  continue
    j=j+1
    if (j .le. j2) goto 150
c----- Store pointer to diagonal element
200  uptr(k) = j
    if (jrow .ne. k .or. luval(j) .eq. 0.0d0) goto 600
    luval(j) = 1.0d0/luval(j)
c----- Refresh all entries of iw to zero.
    do 201 i = j1, j2
        iw(ja(i)) = 0
201  continue
500  continue
c----- Normal return
    icode = 0
    return
c----- Error: zero pivot
600  icode = k
    return
end

```

10.3.3 LEVEL OF FILL AND $ILU(P)$

The accuracy of the $ILU(0)$ incomplete factorization may be insufficient to yield an adequate rate of convergence as shown in Example 10.2. More accurate Incomplete LU factorizations are often more efficient as well as more reliable. These more accurate factoriza-

tions will differ from ILU(0) by allowing some fill-in. Thus, ILU(1) keeps the “first order fill-ins,” a term which will be explained shortly.

To illustrate ILU(p) with the same example as before, the ILU(1) factorization results from taking P to be the zero pattern of the product LU of the factors L, U obtained from ILU(0). This pattern is shown at the bottom right of Figure 10.2. Pretend that the original matrix has this “augmented” pattern $NZ_1(A)$. In other words, the fill-in positions created in this product belong to the augmented pattern $NZ_1(A)$, but their actual values are zero. The new pattern of the matrix A is shown at the bottom left part of Figure 10.3. The factors L_1 and U_1 of the ILU(1) factorization are obtained by performing an ILU(0) factorization on this “augmented pattern” matrix. The patterns of L_1 and U_1 are illustrated at the top of Figure 10.3. The new LU matrix shown at the bottom right of the figure has now two additional diagonals in the lower and upper parts.

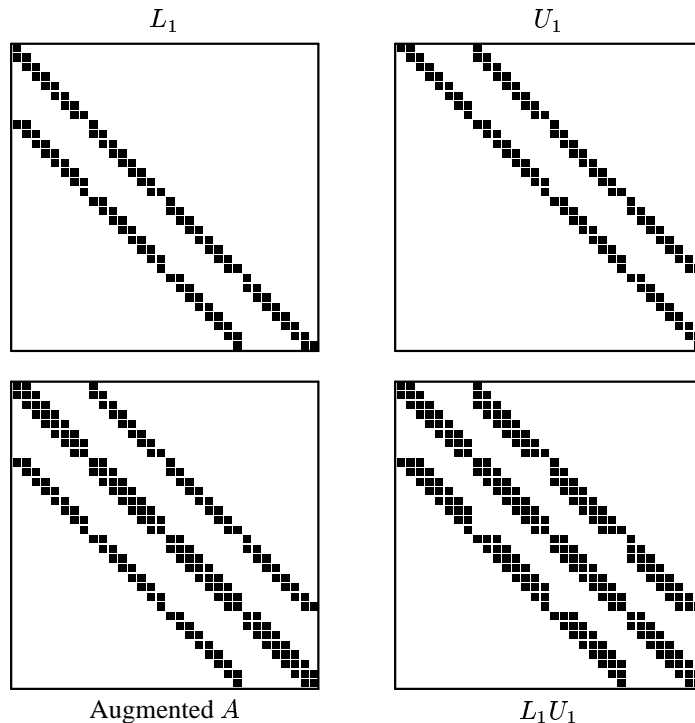

Figure 10.3 The ILU(1) factorization.

One problem with the construction defined in this illustration is that it does not extend to general sparse matrices. It can be generalized by introducing the concept of *level of fill*. A level of fill is attributed to each element that is processed by Gaussian elimination, and dropping will be based on the value of the level of fill. Algorithm 10.2 will be used as a model, although any other form of GE can be used. The rationale is that the level of fill should be indicative of the size: the higher the level, the smaller the elements. A very simple model is employed to justify the definition: A size of ϵ^k is attributed to any element whose level of fill is k , where $\epsilon < 1$. Initially, a nonzero element has a level of fill of one

(this will be changed later) and a zero element has a level of fill of ∞ . An element a_{ij} is updated in line 5 of Algorithm 10.2 by the formula

$$a_{ij} = a_{ij} - a_{ik} \times a_{kj}. \quad (10.17)$$

If lev_{ij} is the current level of the element a_{ij} , then our model tells us that the size of the updated element should be

$$a_{ij} := \epsilon^{lev_{ij}} - \epsilon^{lev_{ik}} \times \epsilon^{lev_{kj}} = \epsilon^{lev_{ij}} - \epsilon^{lev_{ik} + lev_{kj}}.$$

Therefore, roughly speaking, the size of a_{ij} will be the maximum of the two sizes $\epsilon^{lev_{ij}}$ and $\epsilon^{lev_{ik} + lev_{kj}}$, and it is natural to define the new level of fill as,

$$lev_{ij} := \min\{lev_{ij}, lev_{ik} + lev_{kj}\}.$$

In the common definition used in the literature, all the levels of fill are actually shifted by -1 from the definition used above. This is purely for convenience of notation and to conform with the definition used for ILU(0). Thus, initially $lev_{ij} = 0$ if $a_{ij} \neq 0$, and $lev_{ij} = \infty$ otherwise. Thereafter, define recursively

$$lev_{ij} = \min\{lev_{ij}, lev_{ik} + lev_{kj} + 1\}.$$

DEFINITION 10.1 *The initial level of fill of an element a_{ij} of a sparse matrix A is defined by*

$$lev_{ij} = \begin{cases} 0 & \text{if } a_{ij} \neq 0, \text{ or } i = j \\ \infty & \text{otherwise.} \end{cases}$$

Each time this element is modified in line 5 of Algorithm 10.2, its level of fill must be updated by

$$lev_{ij} = \min\{lev_{ij}, lev_{ik} + lev_{kj} + 1\}. \quad (10.18)$$

Observe that the level of fill of an element will never increase during the elimination. Thus, if $a_{ij} \neq 0$ in the original matrix A , then the element in location i, j will have a level of fill equal to zero throughout the elimination process. The above systematic definition gives rise to a natural strategy for discarding elements. In ILU(p), all fill-in elements whose level of fill does not exceed p are kept. So using the definition of zero patterns introduced earlier, the zero pattern for ILU(p) is the set

$$P_p = \{(i, j) \mid lev_{ij} > p\},$$

where lev_{ij} is the level of fill value after all updates (10.18) have been performed. The case $p = 0$ coincides with the ILU(0) factorization and is consistent with the earlier definition.

In practical implementations of the ILU(p) factorization it is common to separate the symbolic phase (where the structure of the L and U factors are determined) from the numerical factorization, when the numerical values are computed. Here, a variant is described which does not separate these two phases. In the following description, a_{i*} denotes the i -th row of the matrix A , and a_{ij} the (i, j) -th entry of A .

ALGORITHM 10.5: ILU(p)

1. For all nonzero elements a_{ij} define $lev(a_{ij}) = 0$
2. For $i = 2, \dots, n$ Do:

3. For each $k = 1, \dots, i - 1$ and for $lev(a_{ik}) \leq p$ Do:
4. Compute $a_{ik} := a_{ik}/a_{kk}$
5. Compute $a_{i*} := a_{i*} - a_{ik}a_{k*}$.
6. Update the levels of fill of the nonzero $a_{i,j}$'s using (10.18)
7. EndDo
8. Replace any element in row i with $lev(a_{ij}) > p$ by zero
9. EndDo

There are a number of drawbacks to the above algorithm. First, the amount of fill-in and computational work for obtaining the $ILU(p)$ factorization is not predictable for $p > 0$. Second, the cost of updating the levels can be quite high. Most importantly, the level of fill-in for indefinite matrices may not be a good indicator of the size of the elements that are being dropped. Thus, the algorithm may drop large elements and result in an inaccurate incomplete factorization, in the sense that $R = LU - A$ is not small. Experience reveals that *on the average* this will lead to a larger number of iterations to achieve convergence, although there are certainly instances where this is not the case. The techniques which will be described in Section 10.4 have been developed to remedy these three difficulties, by producing incomplete factorizations with small error R and a controlled number of fill-ins.

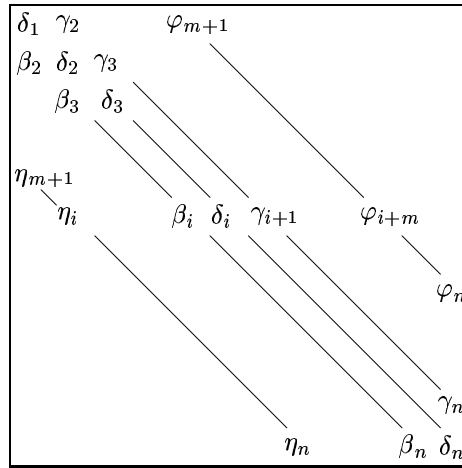

Figure 10.4 Matrix resulting from the discretization of an elliptic problem on a rectangle.

10.3.4 MATRICES WITH REGULAR STRUCTURE

Often, the original matrix has a regular structure which can be exploited to formulate the ILU preconditioners in a simpler way. Historically, incomplete factorization preconditioners were developed first for such matrices, rather than for general sparse matrices. Here, we call a regularly structured matrix a matrix consisting of a small number of diagonals. As an

example, consider the diffusion-convection equation, with Dirichlet boundary conditions

$$-\Delta u + \vec{b} \cdot \nabla u = f \text{ in } \Omega$$

$$u = 0 \text{ on } \partial\Omega$$

where Ω is simply a rectangle. As seen in Chapter 2, if the above problem is discretized using centered differences, a linear system is obtained whose coefficient matrix has the structure shown in Figure 10.4. In terms of the stencils seen in Chapter 4, the representation of this matrix is rather simple. Each row expresses the coupling between unknown i and unknowns $i + 1, i - 1$ which are in the horizontal, or x direction, and the unknowns $i + m$ and $i - m$ which are in the vertical, or y direction. This stencil is represented in Figure 10.5.

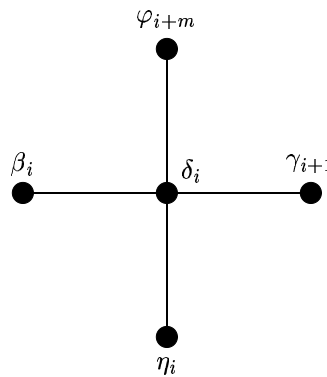

Figure 10.5 Stencil associated with the 5-point matrix shown in Figure 10.4.

The desired L and U matrices in the ILU(0) factorization are shown in Figure 10.6.

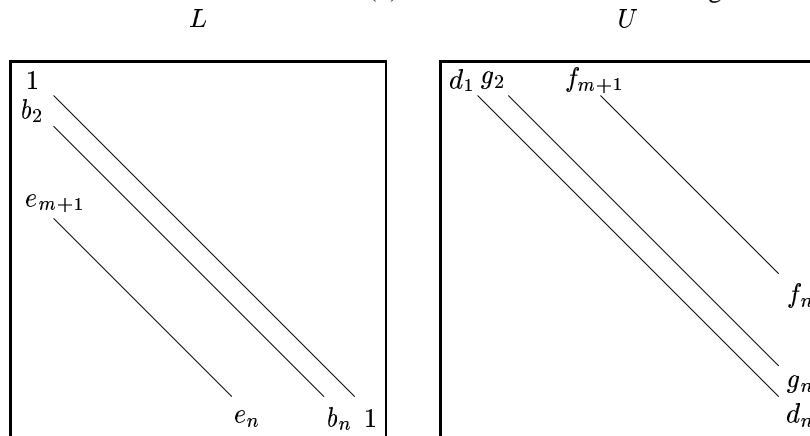

Figure 10.6 L and U factors of the ILU(0) factorization for the 5-point matrix shown in Figure 10.4.

Now the respective stencils of these L and U matrices can be represented at a mesh point i as shown in Figure 10.7.

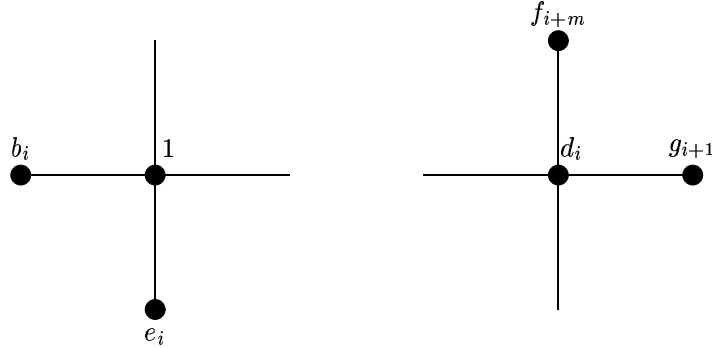

Figure 10.7 Stencils associated with the L and U factors shown in Figure 10.6.

The stencil of the product LU can be obtained easily by manipulating stencils directly rather than working with the matrices they represent. Indeed, the i -th row of LU is obtained by performing the following operation:

$$\text{row}_i(LU) = 1 \times \text{row}_i(U) + b_i \times \text{row}_{i-1}(U) + e_i \times \text{row}_{i-m}(U).$$

This translates into a combination of the stencils associated with the rows:

$$\text{stencil}_i(LU) = 1 \times \text{stencil}_i(U) + b_i \times \text{stencil}_{i-1}(U) + e_i \times \text{stencil}_{i-m}(U)$$

in which $\text{stencil}_j(X)$ represents the stencil of the matrix X based at the mesh point labeled j . This gives the stencil for the LU matrix represented in Figure 10.8.

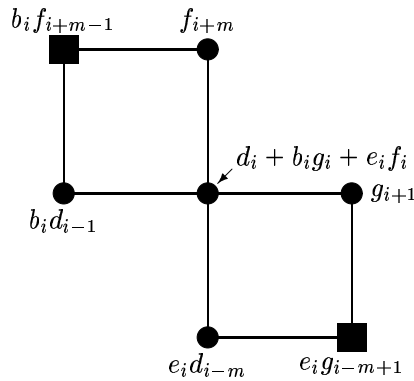

Figure 10.8 Stencil associated with the product of the L and U factors shown in Figure 10.6.

In the figure, the fill-in elements are represented by squares and all other nonzero elements of the stencil are filled circles. The ILU(0) process consists of identifying LU with A in locations where the original a_{ij} 's are nonzero. In the Gaussian eliminations process, this is done from $i = 1$ to $i = n$. This provides the following equations obtained directly from comparing the stencils of LU and A (going from lowest to highest indices)

$$e_i d_{i-m} = \eta_i$$

$$\begin{aligned}
 b_i d_{i-1} &= \beta_i \\
 d_i + b_i g_i + e_i f_i &= \delta_i \\
 g_{i+1} &= \gamma_{i+1} \\
 f_{i+m} &= \varphi_{i+m}.
 \end{aligned}$$

Observe that the elements g_{i+1} and f_{i+m} are identical with the corresponding elements of the A matrix. The other values are obtained from the following recurrence:

$$\begin{aligned}
 e_i &= \frac{\eta_i}{d_{i-m}} \\
 b_i &= \frac{\beta_i}{d_{i-1}} \\
 d_i &= \delta_i - b_i g_i - e_i f_i.
 \end{aligned}$$

The above recurrence can be simplified further by making the observation that the quantities η_i/d_{i-m} and β_i/d_{i-1} need not be saved since they are scaled versions of the corresponding elements in A . With this observation, *only a recurrence for the diagonal elements d_i is needed*. This recurrence is:

$$d_i = \delta_i - \frac{\beta_i \gamma_i}{d_{i-1}} - \frac{\eta_i \varphi_i}{d_{i-m}}, \quad i = 1, \dots, n, \quad (10.19)$$

with the convention that any d_j with a non-positive index j is replaced by 1 and any other element with a negative index is zero. The factorization obtained takes the form

$$M = (D - E)D^{-1}(D - F) \quad (10.20)$$

in which $-E$ is the strict lower diagonal of A , $-F$ is the strict upper triangular part of A , and D is the diagonal obtained with the above recurrence. Note that an ILU(0) based on the IKJ version of Gaussian elimination would give the same result.

For a general sparse matrix A with irregular structure, one can also determine a preconditioner in the form (10.20) by requiring only that the diagonal elements of M match those of A (see Exercise 10). However, this will not give the same ILU factorization as the one based on the IKJ variant of Gaussian elimination seen earlier. Why the ILU(0) factorization gives rise to the same factorization as that of (10.20) is simple to understand: The product of L and U does not change the values of the existing elements in the upper part, except for the diagonal. This also can be interpreted on the adjacency graph of the matrix.

This approach can now be extended to determine the ILU(1) factorization as well as factorizations with higher levels of fill. The stencils of the L and U matrices in the ILU(1) factorization are the stencils of the lower part and upper parts of the LU matrix obtained from ILU(0). These are shown in Figure 10.9. In the illustration, the meaning of a given stencil is not in the usual graph theory sense. Instead, all the marked nodes at a stencil based at node i represent those nodes coupled with unknown i by an equation. Thus, all the filled circles in the picture are adjacent to the central node. Proceeding as before and combining stencils to form the stencil associated with the LU matrix, we obtain the stencil shown in Figure 10.10.

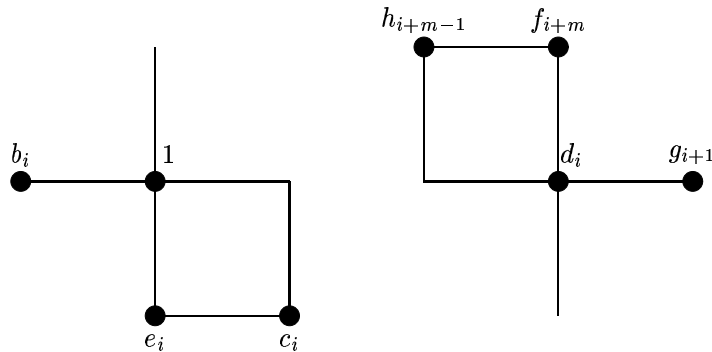

Figure 10.9 Stencils associated with the L and U factors of the $ILU(0)$ factorization for the matrix associated with the stencil of Figure 10.8.

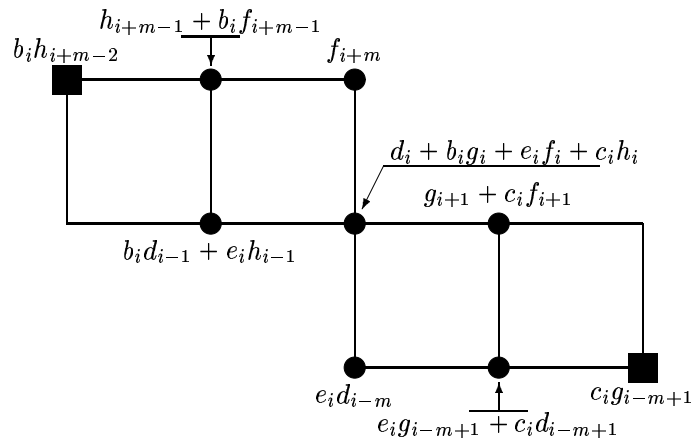

Figure 10.10 Stencil associated with the product of the L and U matrices whose stencils are shown in Figure 10.9.

As before, the fill-in elements are represented by squares and all other elements are filled circles. A typical row of the matrix associated with the above stencil has nine nonzero elements. Two of these are fill-ins, i.e., elements that fall outside the original structure of the L and U matrices. It is now possible to determine a recurrence relation for obtaining the entries of L and U . There are seven equations in all which, starting from the bottom, are

$$\begin{aligned}
 e_i d_{i-m} &= \eta_i \\
 e_i g_{i-m+1} + c_i d_{i-m+1} &= 0 \\
 b_i d_{i-1} + e_i h_{i-1} &= \beta_i \\
 d_i + b_i g_i + e_i f_i + c_i h_i &= \delta_i \\
 g_{i+1} + c_i f_{i+1} &= \gamma_{i+1} \\
 h_{i+m-1} + b_i f_{i+m-1} &= 0 \\
 f_{i+m} &= \varphi_{i+m}.
 \end{aligned}$$

This immediately yields the following recurrence relation for the entries of the L and U factors:

$$\begin{aligned} e_i &= \eta_i / d_{i-m} \\ c_i &= -e_i g_{i-m+1} / d_{i-m+1} \\ b_i &= (\beta_i - e_i h_{i-1}) / d_{i-1} \\ d_i &= \delta_i - b_i g_i - e_i f_i - c_i h_i \\ g_{i+1} &= \gamma_{i+1} - c_i f_{i+1} \\ h_{i+m-1} &= -b_i f_{i+m-1} \\ f_{i+m} &= \varphi_{i+m}. \end{aligned}$$

In proceeding from the nodes of smallest index to those of largest index, we are in effect performing implicitly the IKJ version of Gaussian elimination. The result of the ILU(1) obtained in this manner is therefore identical with that obtained by using Algorithms 10.1 and 10.3.

10.3.5 MODIFIED ILU (MILU)

In all the techniques thus far, the elements that were dropped out during the incomplete elimination process are simply discarded. There are also techniques which attempt to reduce the effect of dropping by *compensating* for the discarded entries. For example, a popular strategy is to add up all the elements that have been dropped at the completion of the k -loop of Algorithm 10.3. Then this sum is subtracted from the diagonal entry in U . This *diagonal compensation* strategy gives rise to the Modified ILU (MILU) factorization.

Thus, in equation (10.14), the final row u_{i*} obtained after completion of the k -loop of Algorithm 10.3 undergoes one more modification, namely,

$$u_{ii} := u_{ii} - (r_{i*}e)$$

in which $e \equiv (1, 1, \dots, 1)^T$. Note that r_{i*} is a row and $r_{i*}e$ is the sum of the elements in this row, i.e., its *row sum*. The above equation can be rewritten in row form as $u_{i*} := u_{i*} - (r_{i*}e)e_i^T$ and equation (10.15) becomes

$$a_{i*} = \sum_{k=1}^i l_{ik} u_{k*} + (r_{i*}e)e_i^T - r_{i*}. \quad (10.21)$$

Observe that

$$a_{i*}e = \sum_{k=1}^i l_{ik} u_{k*}e + (r_{i*}e)e_i^T e - r_{i*}e = \sum_{k=1}^{i-1} l_{ik} u_{k*}e = LU e.$$

This establishes that $Ae = LUe$. As a result, this strategy guarantees that the row sums of A are equal to those of LU . For PDEs, the vector of all ones represents the discretization of a constant function. This additional constraint forces the ILU factorization to be exact for constant functions in some sense. Therefore, it is not surprising that often the algorithm does well for such problems. For other problems or problems with discontinuous coefficients, MILU algorithms usually are not better than their ILU counterparts, in general.

Example 10.3 For regularly structured matrices there are two elements dropped at the i -th step of ILU(0). These are $b_i f_{i+m-1}$ and $e_i g_{i-m+1}$ located on the north-west and south-east corners of the stencil, respectively. Thus, the row sum $r_{i,*}e$ associated with step i is

$$s_i = \frac{\beta_i \phi_{i+m-1}}{d_{i-1}} + \frac{\eta_i \gamma_{m-i+1}}{d_{i-m}}$$

and the MILU variant of the recurrence (10.19) is

$$s_i = \frac{\beta_i \phi_{i+m-1}}{d_{i-1}} + \frac{\eta_i \gamma_{m-i+1}}{d_{i-m}}$$

$$d_i = \delta_i - \frac{\beta_i \gamma_i}{d_{i-1}} - \frac{\eta_i \varphi_i}{d_{i-m}} - s_i.$$

The new ILU factorization is now such that $A = LU - R$ in which according to (10.21) the i -th row of the new remainder matrix R is given by

$$r_{i,*}^{(new)} = (r_{i,*}e)_i^T - r_{i,*}$$

whose row sum is zero.

This generic idea of lumping together all the elements dropped in the elimination process and adding them to the diagonal of U can be used for *any* form of ILU factorization. In addition, there are variants of diagonal compensation in which only a fraction of the dropped elements are added to the diagonal. Thus, the term s_i in the above example would be replaced by ωs_i before being added to u_{ii} , where ω is typically between 0 and 1. Other strategies distribute the sum s_i among nonzero elements of L and U , other than the diagonal.

THRESHOLD STRATEGIES AND ILUT

10.4

Incomplete factorizations which rely on the levels of fill are blind to numerical values because elements that are dropped depend only on the structure of A . This can cause some difficulties for realistic problems that arise in many applications. A few alternative methods are available which are based on dropping elements in the Gaussian elimination process according to their magnitude rather than their locations. With these techniques, the zero pattern P is determined dynamically. The simplest way to obtain an incomplete factorization of this type is to take a sparse direct solver and modify it by adding lines of code which will ignore “small” elements. However, most direct solvers have a complex implementation which involves several layers of data structures that may make this approach ineffective. It is desirable to develop a strategy which is more akin to the ILU(0) approach. This section describes one such technique.

10.4.1 THE ILUT APPROACH

A generic ILU algorithm with threshold can be derived from the IKJ version of Gaussian elimination, Algorithm 10.2, by including a set of rules for dropping small elements. In what follows, *applying a dropping rule to an element* will only mean *replacing the element by zero if it satisfies a set of criteria*. A dropping rule can be applied to a whole row by applying the same rule to all the elements of the row. In the following algorithm, w is a full-length working row which is used to accumulate linear combinations of sparse rows in the elimination and w_k is the k -th entry of this row. As usual, a_{i*} denotes the i -th row of A .

ALGORITHM 10.6: ILUT

1. For $i = 1, \dots, n$ Do:
 2. $w := a_{i*}$
 3. For $k = 1, \dots, i - 1$ and when $w_k \neq 0$ Do:
 4. $w_k := w_k / a_{kk}$
 5. Apply a dropping rule to w_k
 6. If $w_k \neq 0$ then
 7. $w := w - w_k * u_{k*}$
 8. EndIf
 9. EndDo
 10. Apply a dropping rule to row w
 11. $l_{i,j} := w_j$ for $j = 1, \dots, i - 1$
 12. $u_{i,j} := w_j$ for $j = i, \dots, n$
 13. $w := 0$
 14. EndDo
-

Now consider the operations involved in the above algorithm. Line 7 is a sparse update operation. A common implementation of this is to use a full vector for w and a companion pointer which points to the positions of its nonzero elements. Similarly, lines 11 and 12 are sparse-vector copy operations. The vector w is filled with a few nonzero elements after the completion of each outer loop i , and therefore it is necessary to zero out those elements at the end of the Gaussian elimination loop as is done in line 13. This is a sparse *set-to-zero* operation.

ILU(0) can be viewed as a particular case of the above algorithm. The dropping rule for ILU(0) is to drop elements that are in positions not belonging to the original structure of the matrix.

In the factorization $ILUT(p, \tau)$, the following rule is used.

1. In line 5, an element w_k is dropped (i.e., replaced by zero) if it is less than the relative tolerance τ_i obtained by multiplying τ by the original norm of the i -th row (e.g., the 2-norm).
2. In line 10, a dropping rule of a different type is applied. First, drop again any element in the row with a magnitude that is below the relative tolerance τ_i . Then,

keep only the p largest elements in the L part of the row and the p largest elements in the U part of the row in addition to the diagonal element, which is always kept.

The goal of the second dropping step is to control the number of elements per row. Roughly speaking, p can be viewed as a parameter that helps control memory usage, while τ helps to reduce computational cost. There are several possible variations on the implementation of dropping step 2. For example we can keep a number of elements equal to $nu(i) + p$ in the upper part and $nl(i) + p$ in the lower part of the row, where $nl(i)$ and $nu(i)$ are the number of nonzero elements in the L part and the U part of the i -th row of A , respectively. This variant is adopted in the ILUT code used in the examples.

Note that no pivoting is performed. Partial (column) pivoting may be incorporated at little extra cost and will be discussed later. It is also possible to combine ILUT with one of the many standard reorderings, such as the ordering and the nested dissection ordering, or the reverse Cuthill-McKee ordering. Reordering in the context of incomplete factorizations can also be helpful for improving robustness, *provided enough accuracy is used*. For example, when a red-black ordering is used, ILU(0) may lead to poor performance compared with the natural ordering ILU(0). On the other hand, if ILUT is used by allowing gradually more fill-in, then the performance starts improving again. In fact, in some examples, the performance of ILUT for the red-black ordering *eventually outperforms* that of ILUT for the natural ordering using the same parameters p and τ .

10.4.2 ANALYSIS

Existence theorems for the ILUT factorization are similar to those of other incomplete factorizations. If the diagonal elements of the original matrix are positive while the off-diagonal elements are negative, then under certain conditions of diagonal dominance the matrices generated during the elimination will have the same property. If the original matrix is diagonally dominant, then the transformed matrices will also have the property of being diagonally dominant under certain conditions. These properties are analyzed in detail in this section.

The row vector w resulting from line 4 of Algorithm 10.6 will be denoted by $u_{i,*}^{k+1}$. Note that $u_{i,j}^{k+1} = 0$ for $j \leq k$. Lines 3 to 10 in the algorithm involve a sequence of operations of the form

$$l_{ik} := u_{ik}^k / u_{kk}^k \quad (10.22)$$

$$\text{if } |l_{ik}| \text{ small enough set } l_{ik} = 0$$

else:

$$u_{i,j}^{k+1} := u_{i,j}^k - l_{ik} u_{k,j}^k - r_{ij}^k \quad j = k+1, \dots, n \quad (10.23)$$

for $k = 1, \dots, i-1$, in which initially $u_{i,*}^1 := a_{i,*}$ and where r_{ij}^k is an element subtracted from a fill-in element which is being dropped. It should be equal either to zero (no dropping) or to $u_{i,j}^k - l_{ik} u_{k,j}^k$ when the element $u_{i,j}^{k+1}$ is being dropped. At the end of the i -th step of Gaussian elimination (outer loop in Algorithm 10.6), we obtain the i -th row of U ,

$$u_{i,*} \equiv u_{i-1,*}^i \quad (10.24)$$

and the following relation is satisfied:

$$a_{i,*} = \sum_{k=1}^i l_{k,j} u_{i,*}^k + r_{i,*},$$

where $r_{i,*}$ is the row containing all the fill-ins.

The existence result which will be proved is valid only for certain modifications of the basic ILUT(p, τ) strategy. We consider an ILUT strategy which uses the following modification:

- **Drop Strategy Modification.** For any $i < n$, let a_{i,j_i} be the element of largest modulus among the elements $a_{i,j}$, $j = i + 1, \dots, n$, in the original matrix. Then elements generated in position (i, j_i) during the ILUT procedure are not subject to the dropping rule.

This modification prevents elements generated in position (i, j_i) from ever being dropped. Of course, there are many alternative strategies that can lead to the same effect.

A matrix H whose entries h_{ij} satisfy the following three conditions:

$$h_{ii} > 0 \quad \text{for } 1 \leq i < n \quad \text{and} \quad h_{nn} \geq 0 \quad (10.25)$$

$$h_{ij} \leq 0 \quad \text{for } i, j = 1, \dots, n \quad \text{and} \quad i \neq j; \quad (10.26)$$

$$\sum_{j=i+1}^n h_{ij} < 0, \quad \text{for } 1 \leq i < n \quad (10.27)$$

will be referred to as an \hat{M} matrix. The third condition is a requirement that there be at least one nonzero element to the right of the diagonal element, in each row except the last. The row sum for the i -th row is defined by

$$rs(h_{i,*}) = h_{i,*}e = \sum_{j=1}^n h_{i,j}.$$

A given row of an \hat{M} matrix H is *diagonally dominant*, if its row sum is nonnegative. An \hat{M} matrix H is said to be diagonally dominant if all its rows are diagonally dominant. The following theorem is an existence result for ILUT. The underlying assumption is that an ILUT strategy is used with the modification mentioned above.

THEOREM 10.3 *If the matrix A is a diagonally dominant \hat{M} matrix, then the rows $u_{i,*}^k$, $k = 0, 1, 2, \dots, i$ defined by (10.23) starting with $u_{i,*}^0 = 0$ and $u_{i,*}^1 = a_{i,*}$ satisfy the following relations for $k = 1, \dots, l$*

$$u_{ij}^k \leq 0 \quad j \neq i \quad (10.28)$$

$$rs(u_{i,*}^k) \geq rs(u_{i,*}^{k-1}) \geq 0, \quad (10.29)$$

$$u_{ii}^k > 0 \quad \text{when } i < n \quad \text{and} \quad u_{nn}^k \geq 0. \quad (10.30)$$

Proof. The result can be proved by induction on k . It is trivially true for $k = 0$. To prove that the relation (10.28) is satisfied, start from the relation

$$u_{i,*}^{k+1} := u_{i,*}^k - l_{ik} u_{k,*} - r_{i,*}^k$$

in which $l_{ik} \leq 0, u_{k,j} \leq 0$. Either r_{ij}^k is zero which yields $u_{ij}^{k+1} \leq u_{ij}^k \leq 0$, or r_{ij}^k is nonzero which means that u_{ij}^{k+1} is being dropped, i.e., replaced by zero, and therefore again $u_{ij}^{k+1} \leq 0$. This establishes (10.28). Note that by this argument $r_{ij}^k = 0$ except when the j -th element in the row is dropped, in which case $u_{ij}^{k+1} = 0$ and $r_{ij}^k = u_{ij}^k - l_{ik}u_{k,j} \leq 0$. Therefore, $r_{ij}^k \leq 0$, always. Moreover, when an element in position (i, j) is not dropped, then

$$u_{i,j}^{k+1} := u_{i,j}^k - l_{ik}u_{k,j} \leq u_{i,j}^k$$

and in particular by the rule in the modification of the basic scheme described above, for $i < n$, we will always have for $j = j_i$,

$$u_{i,j_i}^{k+1} \leq u_{i,j_i}^k \tag{10.31}$$

in which j_i is defined in the statement of the modification.

Consider the row sum of u_{i*}^{k+1} . We have

$$\begin{aligned} rs(u_{i*}^{k+1}) &= rs(u_{i*}^k) - l_{ik} \quad rs(u_{k,*}) - rs(r_{i*}^k) \\ &\geq rs(u_{i*}^k) - l_{ik} \quad rs(u_{k,*}) \end{aligned} \tag{10.32}$$

$$\geq rs(u_{i*}^k) \tag{10.33}$$

which establishes (10.29) for $k + 1$.

It remains to prove (10.30). From (10.29) we have, for $i < n$,

$$u_{ii}^{k+1} \geq \sum_{j=k+1,n} -u_{i,j}^{k+1} = \sum_{j=k+1,n} |u_{i,j}^{k+1}| \tag{10.34}$$

$$\geq |u_{i,j_i}^{k+1}| \geq |u_{i,j_i}^k| \geq \dots \tag{10.35}$$

$$\geq |u_{i,j_i}^1| = |a_{i,j_i}|. \tag{10.36}$$

Note that the inequalities in (10.35) are true because u_{i,j_i}^k is never dropped by assumption and, as a result, (10.31) applies. By the condition (10.27), which defines \hat{M} matrices, $|a_{i,j_i}|$ is positive for $i < n$. Clearly, when $i = n$, we have by (10.34) $u_{nn} \geq 0$. This completes the proof. ■

The theorem does not mean that the factorization is effective only when its conditions are satisfied. In practice, the preconditioner is efficient under fairly general conditions.

10.4.3 IMPLEMENTATION DETAILS

A poor implementation of ILUT may well lead to an expensive factorization phase, and possibly an impractical algorithm. The following is a list of the potential difficulties that may cause inefficiencies in the implementation of ILUT.

1. Generation of the linear combination of rows of A (Line 7 in Algorithm 10.6).
2. Selection of the p largest elements in L and U .
3. Need to access the elements of L in increasing order of columns (in line 3 of Algorithm 10.6).

For (1), the usual technique is to generate a full row and accumulate the linear combination of the previous rows in it. The row is zeroed again after the whole loop is finished using a sparse set-to-zero operation. A variation on this technique uses only a full integer array $jr(1 : n)$, the values of which are zero except when there is a nonzero element. With this full row, a short real vector $w(1 : maxw)$ must be maintained which contains the real values of the row, as well as a corresponding short integer array $qw(1 : maxw)$ which points to the column position of the real values in the row. When a nonzero element resides in position j of the row, then $jr(j)$ is set to the address k in w, qw where the nonzero element is stored. Thus, $qw(k)$ points to $jr(j)$, and $jr(j)$ points to $qw(k)$ and $w(k)$. This is illustrated in Figure 10.11.

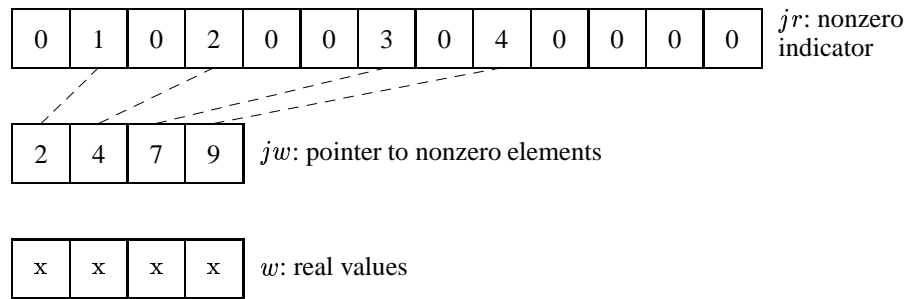

Figure 10.11 Illustration of data structure used for the working row in ILUT.

Note that jr holds the information on the row consisting of both the L part and the U part of the LU factorization. When the linear combinations of the rows are performed, first determine the pivot. Then, unless it is small enough to be dropped according to the dropping rule being used, proceed with the elimination. If a new element in the linear combination is not a fill-in, i.e., if $jr(j) = k \neq 0$, then update the real value $w(k)$. If it is a fill-in ($jr(j) = 0$), then append an element to the arrays w, qw and update jr accordingly.

For (2), the natural technique is to employ a heap-sort strategy. The cost of this implementation would be $O(m+p \times \log_2 m)$, i.e., $O(m)$ for the heap construction and $O(\log_2 m)$ for each extraction. Another implementation is to use a modified quick-sort strategy based on the fact that sorting the array is not necessary. Only the largest p elements must be extracted. This is a *quick-split* technique to distinguish it from the full quick-sort. The method consists of choosing an element, e.g., $x = w(1)$, in the array $w(1 : m)$, then permuting the data so that $|w(k)| \leq |x|$ if $k \leq mid$ and $|w(k)| \geq |x|$ if $k \geq mid$, where mid is some split point. If $mid = p$, then exit. Otherwise, split *one of the left or right sub-arrays* recursively, depending on whether mid is smaller or larger than p . The cost of this strategy *on the average* is $O(m)$. The savings relative to the simpler bubble sort or insertion sort schemes are small for small values of p , but they become rather significant for large p and m .

The next implementation difficulty is that the elements in the L part of the row being built are not in an increasing order of columns. Since these elements must be accessed from left to right in the elimination process, all elements in the row after those already elimi-

nated must be scanned. The one with smallest column number is then picked as the next element to eliminate. This operation can be efficiently organized as a binary search tree which allows easy insertions and searches. However, this improvement is rather complex to implement and is likely to yield moderate gains.

Example 10.4 Tables 10.3 and 10.4 show the results of applying GMRES(10) preconditioned with ILUT(1, 10^{-4}) and ILUT(5, 10^{-4}), respectively, to the five test problems described in Section 3.7. See Example 6.1 for the meaning of the column headers in the table. As shown, all linear systems are now solved in a relatively small number of iterations, with the exception of F2DB which still takes 130 steps to converge with $l_{fil} = 1$ (but only 10 with $l_{fil} = 5$.) In addition, observe a marked improvement in the operation count and error norms. Note that the operation counts shown in the column Kflops do not account for the operations required in the set-up phase to build the preconditioners. For large values of l_{fil} , this may be large.

Matrix	Iters	Kflops	Residual	Error
F2DA	18	964	0.47E-03	0.41E-04
F3D	14	3414	0.11E-02	0.39E-03
ORS	6	341	0.13E+00	0.60E-04
F2DB	130	7167	0.45E-02	0.51E-03
FID	59	19112	0.19E+00	0.11E-03

Table 10.3 A test run of GMRES(10)-ILUT(1, 10^{-4}) preconditioning.

If the total time to solve one linear system with A is considered, a typical curve of the total time required to solve a linear system when the l_{fil} parameter varies would look like the plot shown in Figure 10.12. As l_{fil} increases, a critical value is reached where the preprocessing time and the iteration time are equal. Beyond this critical point, the preprocessing time dominates the total time. If there are several linear systems to solve with the same matrix A , then it is advantageous to use a more accurate factorization, since the cost of the factorization will be amortized. Otherwise, a smaller value of l_{fil} will be more efficient.

Matrix	Iters	Kflops	Residual	Error
F2DA	7	478	0.13E-02	0.90E-04
F3D	9	2855	0.58E-03	0.35E-03
ORS	4	270	0.92E-01	0.43E-04
F2DB	10	724	0.62E-03	0.26E-03
FID	40	14862	0.11E+00	0.11E-03

Table 10.4 A test run of GMRES(10)-ILUT(5, 10^{-4}) preconditioning.

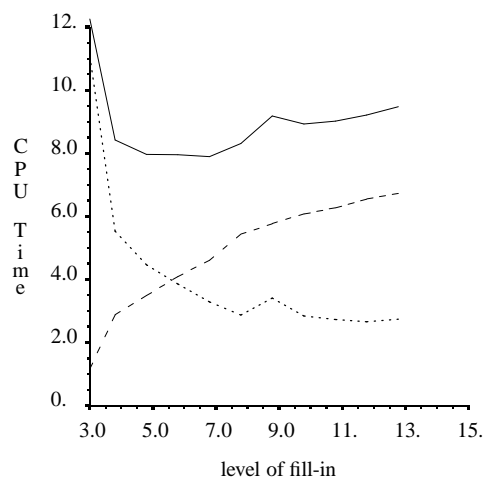

Figure 10.12 Typical CPU time as a function of l_{fil} . The dashed line is the ILUT time, the dotted line is the GMRES time, and the solid line shows the total.

10.4.4 THE ILUTP APPROACH

The ILUT approach may fail for many of the matrices that arise from real applications, for one of the following reasons.

1. The ILUT procedure encounters a zero pivot;
2. The ILUT procedure encounters an overflow or underflow condition, because of an exponential growth of the entries of the factors;
3. The ILUT preconditioner terminates normally but the incomplete factorization preconditioner which is computed is *unstable*.

An unstable ILU factorization is one for which $M^{-1} = U^{-1}L^{-1}$ has a very large norm leading to poor convergence or divergence of the outer iteration. The case (1) can be overcome to a certain degree by assigning an arbitrary nonzero value to a zero diagonal element that is encountered. Clearly, this is not a satisfactory remedy because of the loss in accuracy in the preconditioner. The ideal solution in this case is to use pivoting. However, a form of pivoting is desired which leads to an algorithm with similar cost and complexity to ILUT. Because of the data structure used in ILUT, row pivoting is not practical. Instead, column pivoting can be implemented rather easily.

Here are a few of the features that characterize the new algorithm which is termed ILUTP ("P" stands for pivoting). ILUTP uses a permutation array $perm$ to hold the new orderings of the variables, along with the reverse permutation array. At step i of the elimination process the largest entry in a row is selected and is defined to be the new i -th variable. The two permutation arrays are then updated accordingly. The matrix elements of L and U are kept in their original numbering. However, when expanding the L - U row which corresponds to the i -th outer step of Gaussian elimination, the elements are loaded with respect to the new labeling, using the array $perm$ for the translation. At the end of the process, there are two options. The first is to leave all elements labeled with respect

to the original labeling. No additional work is required since the variables are already in this form in the algorithm, but the variables must then be permuted at each preconditioning step. The second solution is to apply the permutation to all elements of A as well as L/U . This does not require applying a permutation at each step, but rather produces a permuted solution which must be permuted back at the end of the iteration phase. The complexity of the ILUTP procedure is virtually identical to that of ILUT. A few additional options can be provided. A tolerance parameter called *permtol* may be included to help determine whether or not to permute variables: A nondiagonal element a_{ij} is candidate for a permutation only when $tol \times |a_{ij}| > |a_{ii}|$. Furthermore, pivoting may be restricted to take place only within diagonal blocks of a fixed size. The size *mbloc* of these blocks must be provided. A value of $mbloc \geq n$ indicates that there are no restrictions on the pivoting.

For difficult matrices, the following strategy seems to work well:

1. Always apply a scaling to all the rows (or columns) e.g., so that their 1-norms are all equal to 1; then apply a scaling of the columns (or rows).
2. Use a small drop tolerance (e.g., $\epsilon = 10^{-4}$ or $\epsilon = 10^{-5}$).
3. Take a large fill-in parameter (e.g., $lfil = 20$).
4. Do not take a small value for *permtol*. Reasonable values are between 0.5 and 0.01, with 0.5 being the best in many cases.
5. Take $mbloc = n$ unless there are reasons why a given block size is justifiable.

Example 10.5 Table 10.5 shows the results of applying the GMRES algorithm with $ILUTP(1, 10^{-4})$ preconditioning to the five test problems described in Section 3.7. The *permtol* parameter is set to 1.0 in this case.

Matrix	Iters	Kflops	Residual	Error
F2DA	18	964	0.47E-03	0.41E-04
F3D	14	3414	0.11E-02	0.39E-03
ORS	6	341	0.13E+00	0.61E-04
F2DB	130	7167	0.45E-02	0.51E-03
FID	50	16224	0.17E+00	0.18E-03

Table 10.5 A test run of GMRES with $ILUTP(1)$ preconditioning.

See Example 6.1 for the meaning of the column headers in the table. The results are identical with those of $ILUT(1, 10^{-4})$ shown in Table 10.3, for the first four problems, but there is an improvement for the fifth problem.

10.4.5 THE ILUS APPROACH

The ILU preconditioners discussed so far are based mainly on the the IKJ variant of Gaussian elimination. Different types of ILUs can be derived using other forms of Gaussian

elimination. The main motivation for the version to be described next is that ILUT does not take advantage of symmetry. If A is symmetric, then the resulting $M = LU$ is nonsymmetric in general. Another motivation is that in many applications including computational fluid dynamics and structural engineering, the resulting matrices are stored in a *sparse skyline* (SSK) format rather than the standard Compressed Sparse Row format.

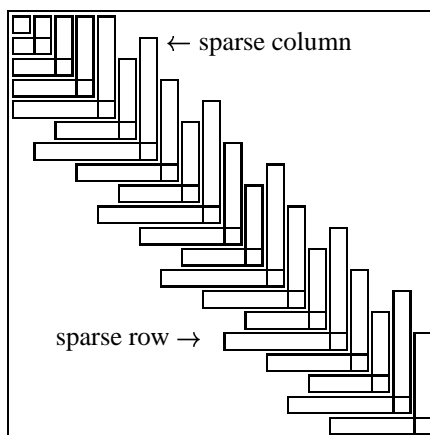

Figure 10.13 Illustration of the sparse skyline format.

In this format, the matrix A is decomposed as

$$A = D + L_1 + L_2^T$$

in which D is a diagonal of A and L_1, L_2 are strictly lower triangular matrices. Then a sparse representation of L_1 and L_2 is used in which, typically, L_1 and L_2 are stored in the CSR format and D is stored separately.

Incomplete Factorization techniques may be developed for matrices in this format without having to convert them into the CSR format. Two notable advantages of this approach are (1) the savings in storage for structurally symmetric matrices, and (2) the fact that the algorithm gives a symmetric preconditioner when the original matrix is symmetric.

Consider the sequence of matrices

$$A_{k+1} = \begin{pmatrix} A_k & v_k \\ w_k & \alpha_{k+1} \end{pmatrix},$$

where $A_n = A$. If A_k is nonsingular and its LDU factorization

$$A_k = L_k D_k U_k$$

is already available, then the LDU factorization of A_{k+1} is

$$A_{k+1} = \begin{pmatrix} L_k & 0 \\ y_k & 1 \end{pmatrix} \begin{pmatrix} D_k & 0 \\ 0 & d_{k+1} \end{pmatrix} \begin{pmatrix} U_k & z_k \\ 0 & 1 \end{pmatrix}$$

in which

$$z_k = D_k^{-1} L_k^{-1} v_k \quad (10.37)$$

$$y_k = w_k U_k^{-1} D_k^{-1} \quad (10.38)$$

$$d_{k+1} = \alpha_{k+1} - y_k D_k z_k. \quad (10.39)$$

Hence, the last row/column pairs of the factorization can be obtained by solving two unit lower triangular systems and computing a scaled dot product. This can be exploited for sparse matrices provided an appropriate data structure is used to take advantage of the sparsity of the matrices L_k , U_k as well as the vectors v_k , w_k , y_k , and z_k . A convenient data structure for this is to store the rows/columns pairs w_k, v_k^T as a single row in sparse mode. All these pairs are stored in sequence. The diagonal elements are stored separately. This is called the Unsymmetric Sparse Skyline (USS) format. Each step of the ILU factorization based on this approach will consist of two approximate sparse linear system solutions and a sparse dot product. The question that arises is: How can a sparse triangular system be solved inexpensively? It would seem natural to solve the triangular systems (10.37) and (10.38) exactly and then drop small terms at the end, using a numerical dropping strategy. However, the total cost of computing the ILU factorization with this strategy would be $O(n^2)$ operations at least, which is not acceptable for very large problems. Since only an approximate solution is required, the first idea that comes to mind is the truncated Neumann series,

$$z_k = D_k^{-1} L_k^{-1} v_k = D_k^{-1} (I + E_k + E_k^2 + \dots + E_k^p) v_k \quad (10.40)$$

in which $E_k \equiv I - L_k$. In fact, by analogy with ILU(p), it is interesting to note that the powers of E_k will also tend to become smaller as p increases. A close look at the structure of $E_k^p v_k$ shows that there is indeed a strong relation between this approach and ILU(p) in the symmetric case. Now we make another important observation, namely, that the vector $E_k^j v_k$ can be computed in *sparse-sparse mode*, i.e., in terms of operations involving products of *sparse matrices by sparse vectors*. Without exploiting this, the total cost would still be $O(n^2)$. When multiplying a sparse matrix A by a sparse vector v , the operation can best be done by accumulating the linear combinations of the columns of A . A sketch of the resulting ILUS algorithm is as follows.

ALGORITHM 10.7: ILUS(ϵ, p)

1. Set $A_1 = D_1 = a_{11}$, $L_1 = U_1 = 1$
 2. For $i = 1, \dots, n - 1$ Do:
 3. Compute z_k by (10.40) in *sparse-sparse mode*
 4. Compute y_k in a similar way
 5. Apply numerical dropping to y_k and z_k
 6. Compute d_{k+1} via (10.39)
 7. EndDo
-

If there are only i nonzero components in the vector v and an average of ν nonzero elements per column, then the total cost per step will be $2 \times i \times \nu$ on the average. Note that the computation of d_k via (10.39) involves the inner product of two sparse vectors which is often implemented by expanding one of the vectors into a full vector and computing the inner product of a sparse vector by this full vector. As mentioned before, in the symmetric case ILUS yields the Incomplete Cholesky factorization. Here, the work can be halved since the generation of y_k is not necessary.

Also note that a simple iterative procedure such as MR or GMRES(m) can be used to solve the triangular systems in sparse-sparse mode. Similar techniques will be seen in Section 10.5. Experience shows that these alternatives are not much better than the Neumann series approach [53].

APPROXIMATE INVERSE PRECONDITIONERS

10.5

The Incomplete LU factorization techniques were developed originally for M -matrices which arise from the discretization of Partial Differential Equations of elliptic type, usually in one variable. For the common situation where A is indefinite, standard ILU factorizations may face several difficulties, and the best known is the fatal breakdown due to the encounter of a zero pivot. However, there are other problems that are just as serious. Consider an incomplete factorization of the form

$$A = LU + E \tag{10.41}$$

where E is the error. The preconditioned matrices associated with the different forms of preconditioning are similar to

$$L^{-1}AU^{-1} = I + L^{-1}EU^{-1}. \tag{10.42}$$

What is sometimes missed is the fact that the error matrix E in (10.41) is not as important as the “preconditioned” error matrix $L^{-1}EU^{-1}$ shown in (10.42) above. When the matrix A is diagonally dominant, then L and U are well conditioned, and the size of $L^{-1}EU^{-1}$ remains confined within reasonable limits, typically with a nice clustering of its eigenvalues around the origin. On the other hand, when the original matrix is not diagonally dominant, L^{-1} or U^{-1} may have very large norms, causing the error $L^{-1}EU^{-1}$ to be very large and thus adding large perturbations to the identity matrix. It can be observed experimentally that ILU preconditioners can be very poor in these situations which often arise when the matrices are indefinite, or have large nonsymmetric parts.

One possible remedy is to try to find a preconditioner that does not require solving a linear system. For example, the original system can be preconditioned by a matrix M which is a direct approximation to the inverse of A .

10.5.1 APPROXIMATING THE INVERSE OF A SPARSE MATRIX

A simple technique for finding approximate inverses of arbitrary sparse matrices is to attempt to find a sparse matrix M which minimizes the Frobenius norm of the residual matrix $I - AM$,

$$F(M) = \|I - AM\|_F^2. \tag{10.43}$$

A matrix M whose value $F(M)$ is small would be a right-approximate inverse of A . Similarly, a left-approximate inverse can be defined by using the objective function

$$\|I - MA\|_F^2. \quad (10.44)$$

Finally, a left-right pair L, U can be sought to minimize

$$\|I - LAU\|_F^2. \quad (10.45)$$

In the following, only (10.43) and (10.45) are considered. The case (10.44) is very similar to the right preconditioner case (10.43). The objective function (10.43) decouples into the sum of the squares of the 2-norms of the individual columns of the residual matrix $I - AM$,

$$F(M) = \|I - AM\|_F^2 = \sum_{j=1}^n \|e_j - Am_j\|_2^2 \quad (10.46)$$

in which e_j and m_j are the j -th columns of the identity matrix and of the matrix M , respectively. There are two different ways to proceed in order to minimize (10.46). The function (10.43) can be minimized globally as a function of the sparse matrix M , e.g., by a gradient-type method. Alternatively, the individual functions

$$f_j(m) = \|e_j - Am\|_2^2, \quad j = 1, 2, \dots, n \quad (10.47)$$

can be minimized. The second approach is appealing for parallel computers, although there is also parallelism to be exploited in the first approach. These two approaches will be discussed in turn.

10.5.2 GLOBAL ITERATION

The *global iteration* approach consists of treating M as an unknown sparse matrix and using a descent-type method to minimize the objective function (10.43). This function is a quadratic function on the space of $n \times n$ matrices, viewed as objects in \mathbb{R}^{n^2} . The proper inner product on the space of matrices, to which the squared norm (10.46) is associated, is

$$\langle X, Y \rangle = \text{tr}(Y^T X). \quad (10.48)$$

In the following, an *array representation* of an n^2 vector X means the $n \times n$ matrix whose column vectors are the successive n -vectors of X .

In a descent algorithm, a new iterate M_{new} is defined by taking a step along a selected direction G , i.e.,

$$M_{new} = M + \alpha G$$

in which α is selected to minimize the objective function $F(M_{new})$. From results seen in Chapter 5, minimizing the residual norm is equivalent to imposing the condition that $R - \alpha AG$ be orthogonal to AG with respect to the $\langle \cdot, \cdot \rangle$ inner product. Thus, the optimal α is given by

$$\alpha = \frac{\langle R, AG \rangle}{\langle AG, AG \rangle} = \frac{\text{tr}(R^T AG)}{\text{tr}((AG)^T AG)}. \quad (10.49)$$

The denominator may be computed as $\|AG\|_F^2$. The resulting matrix M will tend to become denser after each descent step and it is therefore essential to apply a numerical dropping strategy to the resulting M . However, the descent property of the step is now lost, i.e., it is no longer guaranteed that $F(M_{new}) \leq F(M)$. An alternative would be to apply numerical dropping to the direction of search G before taking the descent step. In this case, the amount of fill-in in the matrix M cannot be controlled.

The simplest choice for the descent direction G is to take it to be equal to the residual matrix $R = I - AM$, where M is the new iterate. Except for the numerical dropping step, the corresponding descent algorithm is nothing but the Minimal Residual (MR) algorithm, seen in Section 5.3.2, on the $n^2 \times n^2$ linear system $AM = I$. The global Minimal Residual algorithm will have the following form.

ALGORITHM 10.8: Global Minimal Residual Descent Algorithm

1. Select an initial M
 2. Until convergence Do:
 3. Compute $C := AM$ and $G := I - C$
 4. Compute $\alpha = \text{tr}(G^T AG) / \|C\|_F^2$
 5. Compute $M := M + \alpha G$
 6. Apply numerical dropping to M
 7. EndDo
-

A second choice is to take G to be equal to the direction of steepest descent, i.e., the direction opposite to the gradient of the function (10.43) with respect to M . If all vectors as represented as 2-dimensional $n \times n$ arrays, then the gradient can be viewed as a matrix G , which satisfies the following relation for small perturbations E ,

$$F(M + E) = F(M) + \langle G, E \rangle + o(\|E\|). \quad (10.50)$$

This provides a way of expressing the gradient as an operator on arrays, rather than n^2 vectors.

PROPOSITION 10.3 *The array representation of the gradient of F with respect to M is the matrix*

$$G = -2A^T R$$

in which R is the residual matrix $R = I - AM$.

Proof. For any matrix E we have

$$\begin{aligned} F(M + E) - F(M) &= \text{tr} [(I - A(M + E))^T (I - A(M + E))] \\ &\quad - \text{tr} [(I - A(M))^T (I - A(M))] \\ &= \text{tr} [(R - AE)^T (R - AE) - R^T R] \\ &= -\text{tr} [(AE)^T R + R^T AE - (AE)^T (AE)] \\ &= -2\text{tr}(R^T AE) + \text{tr} [(AE)^T (AE)] \\ &= -2 \langle A^T R, E \rangle + \langle AE, AE \rangle. \end{aligned}$$

Comparing this with (10.50) yields the desired result. ■

Thus, the steepest descent algorithm will consist of replacing G in line 3 of Algorithm 10.8 by $G = A^T R = A^T(I - AM)$. As is expected with steepest descent techniques, the algorithm can be quite slow.

ALGORITHM 10.9: Global Steepest Descent Algorithm

1. Select an initial M
 2. Until convergence Do:
 3. Compute $R = I - AM$, and $G := A^T R$;
 4. Compute $\alpha = \|G\|_F^2 / \|AG\|_F^2$
 5. Compute $M := M + \alpha G$
 6. Apply numerical dropping to M
 7. EndDo
-

In either steepest descent or minimal residual, the G matrix must be stored explicitly. The scalars $\|AG\|_F^2$ and $\text{tr}(G^T AG)$ needed to obtain α in these algorithms can be computed from the successive columns of AG , which can be generated, used, and discarded. As a result, the matrix AG need not be stored.

10.5.3 COLUMN-ORIENTED ALGORITHMS

Column-oriented algorithms consist of minimizing the individual objective functions (10.47) separately. Each minimization can be performed by taking a sparse initial guess and solving approximately the n parallel linear subproblems

$$Am_j = e_j, \quad j = 1, 2, \dots, n \quad (10.51)$$

with a few steps of a nonsymmetric descent-type method, such as MR or GMRES. If these linear systems were solved (approximately) without taking advantage of sparsity, the cost of constructing the preconditioner would be of order n^2 . That is because each of the n columns would require $O(n)$ operations. Such a cost would become unacceptable for large linear systems. To avoid this, the iterations must be performed in *sparse-sparse mode*, a term which was already introduced in Section 10.4.5. The column m_j and the subsequent iterates in the MR algorithm must be stored and operated on as sparse vectors. The Arnoldi basis in the GMRES algorithm are now to be kept in sparse format. Inner products and vector updates involve pairs of sparse vectors.

In the following MR algorithm, n_i iterations are used to solve (10.51) approximately for each column, giving an approximation to the j -th column of the inverse of A . Each initial m_j is taken from the columns of an initial guess, M_0 .

ALGORITHM 10.10: Approximate Inverse via MR Iteration

-
1. Start: set $M = M_0$
 2. For each column $j = 1, \dots, n$ Do:
 3. Define $m_j = Me_j$
 4. For $i = 1, \dots, n_i$ Do:
 5. $r_j := e_j - Am_j$
 6. $\alpha_j := \frac{(r_j, Ar_j)}{(Ar_j, Ar_j)}$
 7. $m_j := m_j + \alpha_j r_j$
 8. Apply numerical dropping to m_j
 9. EndDo
 10. EndDo
-

The algorithm computes the current residual r_j and then minimizes the residual norm $\|e_j - A(m_j + \alpha r_j)\|_2$, with respect to α . The resulting column is then pruned by applying the numerical dropping step in line 8.

In the sparse implementation of MR and GMRES, the matrix-vector product, SAXPY, and dot product kernels now all involve sparse vectors. The matrix-vector product is much more efficient if the sparse matrix is stored by columns, since all the entries do not need to be traversed. Efficient codes for all these kernels may be constructed which utilize a full n -length work vector.

Columns from an initial guess M_0 for the approximate inverse are used as the initial guesses for the iterative solution of the linear subproblems. There are two obvious choices: $M_0 = \alpha I$ and $M_0 = \alpha A^T$. The scale factor α is chosen to minimize the norm of $I - AM_0$. Thus, the initial guess is of the form $M_0 = \alpha G$ where G is either the identity or A^T . The optimal α can be computed using the formula (10.49), in which R is to be replaced by the identity, so $\alpha = \text{tr}(AG)/\text{tr}(AG(AG)^T)$. The identity initial guess is less expensive to use but $M_0 = \alpha A^T$ is sometimes a much better initial guess. For this choice, the initial preconditioned system AM_0 is SPD.

The linear systems needed to solve when generating each column of the approximate inverse may themselves be preconditioned with the most recent version of the preconditioning matrix M . Thus, each system (10.51) for approximating column j may be preconditioned with M'_0 where the first $j - 1$ columns of M'_0 are the m_k that already have been computed, $1 \leq k < j$, and the remaining columns are the initial guesses for the m_k , $j \leq k \leq n$. Thus, *outer* iterations can be defined which sweep over the matrix, as well as *inner* iterations which compute each column. At each outer iteration, the initial guess for each column is taken to be the previous result for that column.

10.5.4 THEORETICAL CONSIDERATIONS

The first theoretical question which arises is whether or not the approximate inverses obtained by the approximations described earlier can be singular. It cannot be proved that M is nonsingular unless the approximation is accurate enough. This requirement may be in conflict with the requirement of keeping the approximation sparse.

PROPOSITION 10.4 Assume that A is nonsingular and that the residual of the approximate inverse M satisfies the relation

$$\|I - AM\| < 1 \quad (10.52)$$

where $\|\cdot\|$ is any consistent matrix norm. Then M is nonsingular.

Proof. The result follows immediately from the equality

$$AM = I - (I - AM) \equiv I - N. \quad (10.53)$$

Since $\|N\| < 1$, Theorem 1.5 seen in Chapter 1 implies that $I - N$ is nonsingular. ■

The result is true in particular for the Frobenius norm which is consistent (see Chapter 1).

It may sometimes be the case that AM is poorly balanced and as a result R can be large. Then balancing AM can yield a smaller norm and possibly a less restrictive condition for the nonsingularity of M . It is easy to extend the previous result as follows. If A is nonsingular and two nonsingular diagonal matrices D_1, D_2 exist such that

$$\|I - D_1 A M D_2\| < 1 \quad (10.54)$$

where $\|\cdot\|$ is any consistent matrix norm, then M is nonsingular.

Each column is obtained independently by requiring a condition on the residual norm of the form

$$\|e_j - Am_j\| \leq \tau, \quad (10.55)$$

for some vector norm $\|\cdot\|$. From a practical point of view the 2-norm is preferable since it is related to the objective function which is used, namely, the Frobenius norm of the residual $I - AM$. However, the 1-norm is of particular interest since it leads to a number of simple theoretical results. In the following, it is assumed that a condition of the form

$$\|e_j - Am_j\|_1 \leq \tau_j \quad (10.56)$$

is required for each column.

The above proposition does not reveal anything about the degree of sparsity of the resulting approximate inverse M . It may well be the case that in order to guarantee nonsingularity, M must be dense, or nearly dense. In fact, in the particular case where the norm in the proposition is the 1-norm, it is known that the approximate inverse may be *structurally dense*, in that it is always possible to find a sparse matrix A for which M will be dense if $\|I - AM\|_1 < 1$.

Next, we examine the sparsity of M and prove a simple result for the case where an assumption of the form (10.56) is made.

PROPOSITION 10.5 Let $B = A^{-1}$ and assume that a given element b_{ij} of B satisfies the inequality

$$|b_{ij}| > \tau_j \max_{k=1, n} |b_{ik}|, \quad (10.57)$$

then the element m_{ij} is nonzero.

Proof. From the equality $AM = I - R$ we have $M = A^{-1} - A^{-1}R$, and hence

$$m_{ij} = b_{ij} - \sum_{k=1}^n b_{ik}r_{kj}.$$

Therefore,

$$\begin{aligned} |m_{ij}| &\geq |b_{ij}| - \sum_{k=1}^n |b_{ik}r_{kj}| \\ &\geq |b_{ij}| - \max_{k=1,n} |b_{ik}| \|r_j\|_1 \\ &\geq |b_{ij}| - \max_{k=1,n} |b_{ik}| \tau_j. \end{aligned}$$

Now the condition (10.57) implies that $|m_{ij}| > 0$. ■

The proposition implies that if R is small enough, then the nonzero elements of M are located in positions corresponding to the larger elements in the inverse of A . The following negative result is an immediate corollary.

COROLLARY 10.1 *Let $\tau = \max_{j=1,\dots,n} \tau_j$. If the nonzero elements of $B = A^{-1}$ are τ -equimodular in that*

$$|b_{ij}| > \tau \max_{k=1,n, l=1,n} |b_{lk}|,$$

then the nonzero sparsity pattern of M includes the nonzero sparsity pattern of A^{-1} . In particular, if A^{-1} is dense and its elements are τ -equimodular, then M is also dense.

The smaller the value of τ , the more likely the condition of the corollary will be satisfied. Another way of stating the corollary is that *accurate* and *sparse* approximate inverses may be computed only if the elements of the actual inverse have variations in size. Unfortunately, this is difficult to verify in advance and it is known to be true only for certain types of matrices.

10.5.5 CONVERGENCE OF SELF PRECONDITIONED MR

We now examine the convergence of the MR algorithm in the case where self preconditioning is used, but no numerical dropping is applied. The column-oriented algorithm is considered first. Let M be the current approximate inverse at a given substep. The self preconditioned MR iteration for computing the j -th column of the next approximate inverse is obtained by the following sequence of operations:

1. $r_j := e_j - Am_j = e_j - AMe_j$
2. $t_j := Mr_j$
3. $\alpha_j := \frac{(r_j, At_j)}{(At_j, At_j)}$
4. $m_j := m_j + \alpha_j t_j$.

Note that α_j can be written as

$$\alpha_j = \frac{(r_j, AMr_j)}{(AMr_j, AMr_j)} \equiv \frac{(r_j, Cr_j)}{(Cr_j, Cr_j)}$$

where

$$C = AM$$

is the preconditioned matrix at the given substep. The subscript j is now dropped to simplify the notation. The new residual associated with the current column is given by

$$r^{new} = r - \alpha Ar = r - \alpha AMr \equiv r - \alpha Cr.$$

The orthogonality of the new residual against AMr can be used to obtain

$$\|r^{new}\|_2^2 = \|r\|_2^2 - \alpha^2 \|Cr\|_2^2.$$

Replacing α by its value defined above we get

$$\|r^{new}\|_2^2 = \|r\|_2^2 \left[1 - \left(\frac{(Cr, r)}{\|Cr\|_2 \|r\|_2} \right)^2 \right].$$

Thus, at each inner iteration, the residual norm for the j -th column is reduced according to the formula

$$\|r^{new}\|_2 = \|r\|_2 \sin \angle(r, Cr) \tag{10.58}$$

in which $\angle(u, v)$ denotes the acute angle between the vectors u and v . Assume that each column converges. Then, the preconditioned matrix C converges to the identity. As a result of this, the angle $\angle(r, Cr)$ will tend to $\angle(r, r) = 0$, and therefore the convergence ratio $\sin \angle(r, Cr)$ will also tend to zero, showing superlinear convergence.

Now consider equation (10.58) more carefully. Denote by R the residual matrix $R = I - AM$ and observe that

$$\begin{aligned} \sin \angle(r, Cr) &= \min_{\alpha} \frac{\|r - \alpha Cr\|_2}{\|r\|_2} \\ &\leq \frac{\|r - Cr\|_2}{\|r\|_2} \equiv \frac{\|Rr\|_2}{\|r\|_2} \\ &\leq \|R\|_2. \end{aligned}$$

This results in the following statement.

PROPOSITION 10.6 *Assume that the self preconditioned MR algorithm is employed with one inner step per iteration and no numerical dropping. Then the 2-norm of each residual $e_j - Am_j$ of the j -th column is reduced by a factor of at least $\|I - AM\|_2$, where M is the approximate inverse before the current step, i.e.,*

$$\|r_j^{new}\|_2 \leq \|I - AM\|_2 \|r_j\|_2. \tag{10.59}$$

In addition, the residual matrices $R_k = I - AM_k$ obtained after each outer iteration satisfy

$$\|R_{k+1}\|_F \leq \|R_k\|_F^2. \tag{10.60}$$

As a result, when the algorithm converges, it does so quadratically.

Proof. Inequality (10.59) was proved above. To prove quadratic convergence, first use the inequality $\|X\|_2 \leq \|X\|_F$ and (10.59) to obtain

$$\|r_j^{new}\|_2 \leq \|R_{k,j}\|_F \|r_j\|_2.$$

Here, the k index corresponds to the outer iteration and the j -index to the column. Note that the Frobenius norm is reduced for each of the inner steps corresponding to the columns, and therefore,

$$\|R_{k,j}\|_F \leq \|R_k\|_F.$$

This yields

$$\|r_j^{new}\|_2^2 \leq \|R_k\|_F^2 \|r_j\|_2^2$$

which, upon summation over j , gives

$$\|R_{k+1}\|_F \leq \|R_k\|_F^2.$$

This completes the proof. ■

Note that the above theorem does not prove convergence. It only states that when the algorithm converges, it does so quadratically at the limit. In addition, the result ceases to be valid in the presence of dropping.

Consider now the case of the global iteration. When self preconditioning is incorporated into the global MR algorithm (Algorithm 10.8), the search direction becomes $Z_k = M_k R_k$, where R_k is the current residual matrix. Then, the main steps of the algorithm (without dropping) are as follows.

1. $R_k := I - AM_k$
2. $Z_k := M_k R_k$
3. $\alpha_k := \frac{\langle R_k, AZ_k \rangle}{\langle AZ_k, AZ_k \rangle}$
4. $M_{k+1} := M_k + \alpha_k Z_k$

At each step the new residual matrix R_{k+1} satisfies the relation

$$R_{k+1} = I - AM_{k+1} = I - A(M_k + \alpha_k Z_k) = R_k - \alpha_k AZ_k.$$

An important observation is that R_k is a polynomial in R_0 . This is because, from the above relation,

$$R_{k+1} = R_k - \alpha_k AM_k R_k = R_k - \alpha_k (I - R_k) R_k = (1 - \alpha_k) R_k + \alpha_k R_k^2. \quad (10.61)$$

Therefore, induction shows that $R_{k+1} = p_{2^k}(R_0)$ where p_j is a polynomial of degree j . Now define the preconditioned matrices,

$$B_k \equiv AM_k = I - R_k. \quad (10.62)$$

Then, the following recurrence follows from (10.61),

$$B_{k+1} = B_k + \alpha_k B_k (I - B_k) \quad (10.63)$$

and shows that B_{k+1} is also a polynomial of degree 2^k in B_0 . In particular, *if the initial B_0 is symmetric, then so are all subsequent B_k 's*. This is achieved when the initial M is a multiple of A^T , namely if $M_0 = \alpha_0 A^T$.

Similar to the column oriented case, when the algorithm converges it does so quadratically.

PROPOSITION 10.7 *Assume that the self preconditioned global MR algorithm is used without dropping. Then, the residual matrices obtained at each iteration satisfy*

$$\|R_{k+1}\|_F \leq \|R_k^2\|_F. \quad (10.64)$$

As a result, when the algorithm converges, then it does so quadratically.

Proof. Define for any α ,

$$R(\alpha) = (1 - \alpha)R_k + \alpha R_k^2$$

Recall that α_k achieves the minimum of $\|R(\alpha)\|_F$ over all α 's. In particular,

$$\begin{aligned} \|R_{k+1}\|_F &= \min_{\alpha} \|R(\alpha)\|_F \\ &\leq \|R(1)\|_F = \|R_k^2\|_F \\ &\leq \|R_k\|_F^2. \end{aligned} \quad (10.65)$$

This proves quadratic convergence at the limit. ■

For further properties see Exercise 16.

10.5.6 FACTORED APPROXIMATE INVERSES

A notable disadvantage of the right or left preconditioning approach method is that it is difficult to assess in advance whether or not the resulting approximate inverse M is nonsingular. An alternative would be to seek a two-sided approximation, i.e., a pair L, U , with L lower triangular and U upper triangular, which attempts to minimize the objective function (10.45). The techniques developed in the previous sections can be exploited for this purpose.

In the factored approach, two matrices L and U which are *unit* lower and upper triangular matrices are sought such that

$$LAU \approx D$$

where D is some unknown diagonal matrix. When D is nonsingular and $LAU = D$, then L, U are called *inverse LU factors* of A since in this case $A^{-1} = UD^{-1}L$. Once more, the matrices are built one column or row at a time. Assume as in Section 10.4.5 that we have the sequence of matrices

$$A_{k+1} = \begin{pmatrix} A_k & v_k \\ w_k & \alpha_{k+1} \end{pmatrix}$$

in which $A_n \equiv A$. If the inverse factors L_k, U_k are available for A_k , i.e.,

$$L_k A_k U_k = D_k,$$

then the inverse factors L_{k+1}, U_{k+1} for A_{k+1} are easily obtained by writing

$$\begin{pmatrix} L_k & 0 \\ -y_k & 1 \end{pmatrix} \begin{pmatrix} A_k & v_k \\ w_k & \alpha_{k+1} \end{pmatrix} \begin{pmatrix} U_k & -z_k \\ 0 & 1 \end{pmatrix} = \begin{pmatrix} D_k & 0 \\ 0 & \delta_{k+1} \end{pmatrix} \quad (10.66)$$

in which $z_k, y_k,$ and δ_{k+1} are such that

$$A_k z_k = v_k \quad (10.67)$$

$$y_k A_k = w_k \quad (10.68)$$

$$\delta_{k+1} = \alpha_{k+1} - w_k z_k = \alpha_{k+1} - y_k v_k. \quad (10.69)$$

Note that the formula (10.69) exploits the fact that either the system (10.67) is solved exactly (middle expression) or the system (10.68) is solved exactly (second expression) or both systems are solved exactly (either expression). In the realistic situation where neither of these two systems is solved exactly, then this formula should be replaced by

$$\delta_{k+1} = \alpha_{k+1} - w_k z_k - y_k v_k + y_k A_k z_k. \quad (10.70)$$

The last row/column pairs of the approximate factored inverse can be obtained by solving two sparse systems and computing a few dot products. It is interesting to note that the only difference with the ILUS factorization seen in Section 10.4.5 is that *the coefficient matrices for these systems are not the triangular factors of A_k , but the matrix A_k itself.*

To obtain an approximate factorization, simply exploit the fact that the A_k matrices are sparse and then employ iterative solvers in sparse-sparse mode. In this situation, formula (10.70) should be used for δ_{k+1} . The algorithm would be as follows.

ALGORITHM 10.11: Approximate Inverse Factors Algorithm

1. For $k = 1, \dots, n$ Do:
 2. Solve (10.67) approximately;
 3. Solve (10.68) approximately;
 4. Compute $\delta_{k+1} = \alpha_{k+1} - w_k z_k - y_k v_k + y_k A_k z_k$
 5. EndDo
-

A linear system must be solved with A_k in line 2 and a linear system with A_k^T in line 3. This is a good scenario for the Biconjugate Gradient algorithm or its equivalent two-sided Lanczos algorithm. In addition, the most current approximate inverse factors can be used to precondition the linear systems to be solved in steps 2 and 3. This was termed “self preconditioning” earlier. All the linear systems in the above algorithm can be solved in parallel since they are independent of one another. The diagonal D can then be obtained at the end of the process.

This approach is particularly suitable in the symmetric case. Since there is only one factor, the amount of work is halved. In addition, there is no problem with the existence in the positive definite case as is shown in the following lemma which states that δ_{k+1} is always > 0 when A is SPD, independently of the accuracy with which the system (10.67) is solved.

LEMMA 10.1 *Let A be SPD. Then, the scalar δ_{k+1} as computed by (10.70) is positive.*

Proof. In the symmetric case, $w_k = v_k^T$. Note that δ_{k+1} as computed by formula (10.70) is the $(k + 1, k + 1)$ element of the matrix $L_{k+1}A_{k+1}L_{k+1}^T$. It is positive because A_{k+1} is SPD. This is independent of the accuracy for solving the system to obtain z_k . ■

In the general nonsymmetric case, there is no guarantee that δ_{k+1} will be nonzero, unless the systems (10.67) and (10.68) are solved accurately enough. There is no practical problem here, since δ_{k+1} is computable. The only question remaining is a theoretical one: Can δ_{k+1} be guaranteed to be nonzero if the systems are solved with enough accuracy? Intuitively, if the system is solved exactly, then the D matrix must be nonzero since it is equal to the D matrix of the exact inverse factors in this case. The minimal assumption to make is that each A_k is nonsingular. Let δ_{k+1}^* be the value that would be obtained if at least one of the systems (10.67) or (10.68) is solved exactly. According to equation (10.69), in this situation this value is given by

$$\delta_{k+1}^* = \alpha_{k+1} - w_k A_k^{-1} v_k. \tag{10.71}$$

If A_{k+1} is nonsingular, then $\delta_{k+1}^* \neq 0$. To see this refer to the defining equation (10.66) and compute the product $L_{k+1}A_{k+1}U_{k+1}$ in the general case. Let r_k and s_k be the residuals obtained for these linear systems, i.e.,

$$r_k = v_k - A_k z_k, \quad s_k = w_k - y_k A_k. \tag{10.72}$$

Then a little calculation yields

$$L_{k+1}A_{k+1}U_{k+1} = \begin{pmatrix} L_k A_k U_k & L_k r_k \\ s_k U_k & \delta_{k+1} \end{pmatrix}. \tag{10.73}$$

If one of r_k or s_k is zero, then it is clear that the term δ_{k+1} in the above relation becomes δ_{k+1}^* and it must be nonzero since the matrix on the left-hand side is nonsingular. Incidentally, this relation shows the structure of the last matrix $L_n A_n U_n \equiv LAU$. The components 1 to $j - 1$ of column j consist of the vector $L_j r_j$, the components 1 to $j - 1$ of row i make up the vector $s_k U_k$, and the diagonal elements are the δ_i 's. Consider now the expression for δ_{k+1} from (10.70).

$$\begin{aligned} \delta_{k+1} &= \alpha_{k+1} - w_k z_k - y_k v_k + y_k A_k z_k \\ &= \alpha_{k+1} - w_k A_k^{-1} (v_k - r_k) - (w_k - s_k) A_k^{-1} v_k + (v_k - r_k) A_k^{-1} (w_k - s_k) \\ &= \alpha_{k+1} - v_k A_k^{-1} w_k + r_k A_k^{-1} s_k \\ &= \delta_{k+1}^* + r_k A_k^{-1} s_k. \end{aligned}$$

This perturbation formula is of a second order in the sense that $|\delta_{k+1} - \delta_{k+1}^*| = O(\|r_k\| \|s_k\|)$. It guarantees that δ_{k+1} is nonzero whenever $|r_k A_k^{-1} s_k| < |\delta_{k+1}^*|$.

10.5.7 IMPROVING A PRECONDITIONER

After a computed ILU factorization results in an unsatisfactory convergence, it is difficult to improve it by modifying the L and U factors. One solution would be to discard this factorization and attempt to recompute a fresh one possibly with more fill-in. Clearly, this may be a wasteful process. A better alternative is to use approximate inverse techniques. Assume a (sparse) matrix M is a preconditioner to the original matrix A , so the precondi-

tioned matrix is

$$C = M^{-1}A.$$

A sparse matrix S is sought to approximate the inverse of $M^{-1}A$. This matrix is then to be used as a preconditioner to $M^{-1}A$. Unfortunately, the matrix C is usually dense. However, observe that all that is needed is a matrix S such that

$$AS \approx M.$$

Recall that the columns of A and M are sparse. One approach is to compute a least-squares approximation in the Frobenius norm sense. This approach was used already in Section 10.5.1 when M is the identity matrix. Then the columns of S were obtained by approximately solving the linear systems $As_i \approx e_i$. The same idea can be applied here. Now, the systems

$$As_i = m_i$$

must be solved instead, where m_i is the i -th column of M which is sparse. Thus, the coefficient matrix and the right-hand side are sparse, as before.

BLOCK PRECONDITIONERS

10.6

Block preconditioning is a popular technique for block-tridiagonal matrices arising from the discretization of elliptic problems. It can also be generalized to other sparse matrices. We begin with a discussion of the block-tridiagonal case.

10.6.1 BLOCK-TRIDIAGONAL MATRICES

Consider a block-tridiagonal matrix blocked in the form

$$A = \begin{pmatrix} D_1 & E_2 & & & \\ F_2 & D_2 & E_3 & & \\ & \ddots & \ddots & \ddots & \\ & & F_{m-1} & D_{m-1} & E_m \\ & & & F_m & D_m \end{pmatrix}. \quad (10.74)$$

One of the most popular block preconditioners used in the context of PDEs is based on this block-tridiagonal form of the coefficient matrix A . Let D be the block-diagonal matrix consisting of the diagonal blocks D_i , L the block strictly-lower triangular matrix consisting of the sub-diagonal blocks F_i , and U the block strictly-upper triangular matrix consisting of the super-diagonal blocks E_i . Then, the above matrix has the form

$$A = L + D + U.$$

A block ILU preconditioner is defined by

$$M = (L + \Delta)\Delta^{-1}(\Delta + U), \quad (10.75)$$

where L and U are the same as above, and Δ is a block-diagonal matrix whose blocks Δ_i are defined by the recurrence:

$$\Delta_i = D_i - F_i\Omega_{i-1}E_i, \quad (10.76)$$

in which Ω_j is some sparse approximation to Δ_j^{-1} . Thus, to obtain a block factorization, approximations to the inverses of the blocks Δ_i must be found. This clearly will lead to difficulties if explicit inverses are used.

An important particular case is when the diagonal blocks D_i of the original matrix are tridiagonal, while the co-diagonal blocks E_i and F_i are diagonal. Then, a simple recurrence formula for computing the inverse of a tridiagonal matrix can be exploited. Only the tridiagonal part of the inverse must be kept in the recurrence (10.76). Thus,

$$\Delta_1 = D_1, \quad (10.77)$$

$$\Delta_i = D_i - F_i\Omega_{i-1}^{(3)}E_i, \quad i = 1, \dots, m, \quad (10.78)$$

where $\Omega_k^{(3)}$ is the tridiagonal part of Δ_k^{-1} .

$$(\Omega_k^{(3)})_{i,j} = (\Delta_k^{-1})_{i,j} \quad \text{for } |i - j| \leq 1.$$

The following theorem can be shown.

THEOREM 10.4 *Let A be Symmetric Positive Definite and such that*

- $a_{ii} > 0$, $i = 1, \dots, n$, and $a_{ij} \leq 0$ for all $j \neq i$.
- The matrices D_i are all (strict) diagonally dominant.

Then each block Δ_i computed by the recurrence (10.77), (10.78) is a symmetric M -matrix. In particular, M is also a positive definite matrix.

We now show how the inverse of a tridiagonal matrix can be obtained. Let a tridiagonal matrix Δ of dimension l be given in the form

$$\Delta = \begin{pmatrix} \alpha_1 & -\beta_2 & & & \\ -\beta_2 & \alpha_2 & -\beta_3 & & \\ & \ddots & \ddots & \ddots & \\ & & -\beta_{l-1} & \alpha_{l-1} & -\beta_l \\ & & & -\beta_l & \alpha_l \end{pmatrix},$$

and let its Cholesky factorization be

$$\Delta = LDL^T,$$

with

$$D = \text{diag } \{\delta_i\}$$

and

$$L = \begin{pmatrix} 1 & & & & \\ -\gamma_2 & 1 & & & \\ & \ddots & \ddots & & \\ & & -\gamma_{l-1} & 1 & \\ & & & -\gamma_l & 1 \end{pmatrix}.$$

The inverse of Δ is $L^{-T}D^{-1}L^{-1}$. Start by observing that the inverse of L^T is a unit upper triangular matrix whose coefficients u_{ij} are given by

$$u_{ij} = \gamma_{i+1}\gamma_{i+2}\cdots\gamma_{j-1}\gamma_j \quad \text{for } 1 \leq i < j < l.$$

As a result, the j -th column c_j of L^{-T} is related to the $(j-1)$ -st column c_{j-1} by the very simple recurrence,

$$c_j = e_j + \gamma_j c_{j-1}, \quad \text{for } j \geq 2$$

starting with the first column $c_1 = e_1$. The inverse of Δ becomes

$$\Delta^{-1} = L^{-T}D^{-1}L^{-1} = \sum_{j=1}^l \frac{1}{\delta_j} c_j c_j^T. \quad (10.79)$$

See Exercise 12 for a proof of the above equality. As noted, the recurrence formulas for computing Δ^{-1} can be unstable and lead to numerical difficulties for large values of l .

10.6.2 GENERAL MATRICES

A general sparse matrix can often be put in the form (10.74) where the blocking is either natural as provided by the physical problem, or artificial when obtained as a result of RCMK ordering and some block partitioning. In such cases, a recurrence such as (10.76) can still be used to obtain a block factorization defined by (10.75). A 2-level preconditioner can be defined by using sparse inverse approximate techniques to approximate Ω_i . These are sometimes termed implicit-explicit preconditioners, the implicit part referring to the block-factorization and the explicit part to the approximate inverses used to explicitly approximate Δ_i^{-1} .

PRECONDITIONERS FOR THE NORMAL EQUATIONS

10.7

When the original matrix is strongly indefinite, i.e., when it has eigenvalues spread on both sides of the imaginary axis, the usual Krylov subspace methods may fail. The Conjugate Gradient approach applied to the normal equations may then become a good alternative. Choosing to use this alternative over the standard methods may involve inspecting the spectrum of a Hessenberg matrix obtained from a small run of an unpreconditioned GMRES algorithm.

If the normal equations approach is chosen, the question becomes how to precondition the resulting iteration. An ILU preconditioner can be computed for A and the preconditioned normal equations,

$$A^T(LU)^{-T}(LU)^{-1}Ax = A^T(LU)^{-T}(LU)^{-1}b,$$

can be solved. However, when A is not diagonally dominant the ILU factorization process may encounter a zero pivot. Even when this does not happen, the resulting preconditioner may be of poor quality. An incomplete factorization routine with pivoting, such as ILUTP, may constitute a good choice. ILUTP can be used to precondition either the original equations or the normal equations shown above. This section explores a few other options available for preconditioning the normal equations.

10.7.1 JACOBI, SOR, AND VARIANTS

There are several ways to exploit the relaxation schemes for the Normal Equations seen in Chapter 8 as preconditioners for the CG method applied to either (8.1) or (8.3). Consider (8.3), for example, which requires a procedure delivering an approximation to $(AA^T)^{-1}v$ for any vector v . One such procedure is to perform one step of SSOR to solve the system $(AA^T)w = v$. Denote by M^{-1} the linear operator that transforms v into the vector resulting from this procedure, then the usual Conjugate Gradient method applied to (8.3) can be recast in the same form as Algorithm 8.5. This algorithm is known as CGNE/SSOR. Similarly, it is possible to incorporate the SSOR preconditioning in Algorithm 8.4, which is associated with the Normal Equations (8.1), by defining M^{-1} to be the linear transformation that maps a vector v into a vector w resulting from the forward sweep of Algorithm 8.2 followed by a backward sweep. We will refer to this algorithm as CGNR/SSOR.

The CGNE/SSOR and CGNR/SSOR algorithms will not break down if A is nonsingular, since then the matrices AA^T and $A^T A$ are Symmetric Positive Definite, as are the preconditioning matrices M . There are several variations to these algorithms. The standard alternatives based on the same formulation (8.1) are either to use the preconditioner on the right, solving the system $A^T A M^{-1} y = b$, or to split the preconditioner into a forward SOR sweep on the left and a backward SOR sweep on the right of the matrix $A^T A$. Similar options can also be written for the Normal Equations (8.3) again with three different ways of preconditioning. Thus, at least six different algorithms can be defined.

10.7.2 IC(0) FOR THE NORMAL EQUATIONS

The Incomplete Cholesky IC(0) factorization can be used to precondition the Normal Equations (8.1) or (8.3). This approach may seem attractive because of the success of incomplete factorization preconditioners. However, a major problem is that the Incomplete Cholesky factorization is not guaranteed to exist for an arbitrary Symmetric Positive Definite matrix B . All the results that guarantee existence rely on some form of diagonal dominance. One of the first ideas suggested to handle this difficulty was to use an Incomplete Cholesky factorization on the “shifted” matrix $B + \alpha I$. We refer to IC(0) applied to $B = A^T A$ as ICNR(0), and likewise IC(0) applied to $B = AA^T$

as ICNE(0). Shifted variants correspond to applying IC(0) to the shifted B matrix.

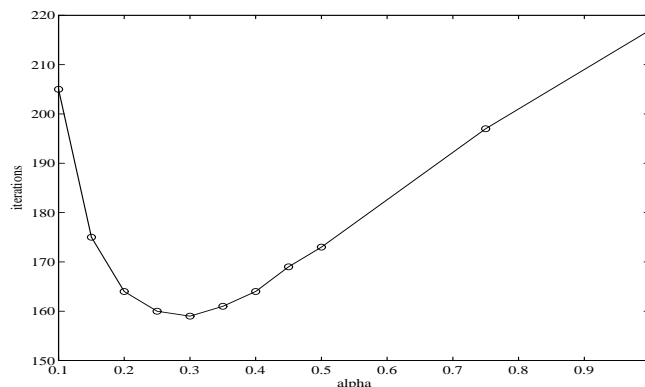

Figure 10.14 Iteration count as a function of the shift α .

One issue often debated is how to find good values for the shift α . There is no easy and well-founded solution to this problem for irregularly structured symmetric sparse matrices. One idea is to select the smallest possible α that makes the shifted matrix diagonally dominant. However, this shift tends to be too large in general because IC(0) may exist for much smaller values of α . Another approach is to determine the smallest α for which the IC(0) factorization exists. Unfortunately, this is not a viable alternative. As is often observed, the number of steps required for convergence starts decreasing as α increases, and then increases again. An illustration of this is shown in Figure 10.14. This plot suggests that there is an optimal value for α which is far from the smallest admissible one. For small α , the diagonal dominance of $B + \alpha I$ is weak and, as a result, the computed IC factorization is a poor approximation to the matrix $B(\alpha) \equiv B + \alpha I$. In other words, $B(\alpha)$ is close to the original matrix B , but the IC(0) factorization is far from $B(\alpha)$. For large α , the opposite is true. The matrix $B(\alpha)$ has a large deviation from $B(0)$, but its IC(0) factorization may be quite good. Therefore, the general shape of the curve shown in the figure is not too surprising.

To implement the algorithm, the matrix $B = AA^T$ need not be formed explicitly. All that is required is to be able to access one row of B at a time. This row can be computed, used, and then discarded. In the following, the i -th row $e_i^T A$ of A is denoted by a_i . The algorithm is row-oriented and all vectors denote row vectors. It is adapted from the ILU(0) factorization of a sparse matrix, i.e., Algorithm 10.4, but it actually computes the LDL^T factorization instead of an LU or LL^T factorization. The main difference with Algorithm 10.4 is that the loop in line 7 is now restricted to $j \leq i$ because of symmetry. If only the l_{ij} elements are stored row-wise, then the rows of $U = L^T$ which are needed in this loop are not directly available. Denote the j -th row of $U = L^T$ by u_j . These rows are accessible by adding a column data structure for the L matrix which is updated dynamically. A linked list data structure can be used for this purpose. With this in mind, the IC(0) algorithm will have the following structure.

ALGORITHM 10.12: Shifted ICNE(0)

1. *Initial step: Set $d_1 := a_{11}$, $l_{11} = 1$*
2. *For $i = 2, 3, \dots, n$ Do:*
3. *Obtain all the nonzero inner products*
4. $l_{ij} = (a_j, a_i), j = 1, 2, \dots, i - 1$, and $l_{ii} := \|a_i\|^2 + \alpha$
5. Set $NZ(i) \equiv \{j \mid l_{ij} \neq 0\}$
6. *For $k = 1, \dots, i - 1$ and if $k \in NZ(i)$ Do:*
7. *Extract row $u_k = (Le_k)^T$*
8. *Compute $l_{ik} := l_{ik}/d_k$*
9. *For $j = k + 1, \dots, i$ and if $(i, j) \in NZ(i)$ Do:*
10. *Compute $l_{ik} := l_{ik} - l_{ij}u_{kj}$*
11. *EndDo*
12. *EndDo*
13. Set $d_i := l_{ii}$, $l_{ii} := 1$
14. *EndDo*

Note that initially the row u_1 in the algorithm is defined as the first row of A . All vectors in the algorithm are row vectors.

The step represented by lines 3 and 4, which computes the inner products of row number i with all previous rows, needs particular attention. If the inner products

$$a_1^T a_i, a_2^T a_i, \dots, a_{i-1}^T a_i$$

are computed separately, the total cost of the incomplete factorization would be of the order of n^2 steps and the algorithm would be of little practical value. However, most of these inner products are equal to zero because of sparsity. This indicates that it may be possible to compute only those nonzero inner products at a much lower cost. Indeed, if c is the column of the $i - 1$ inner products c_{ij} , then c is the product of the rectangular $(i - 1) \times n$ matrix A_{i-1} whose rows are a_1^T, \dots, a_{i-1}^T by the vector a_i , i.e.,

$$c = A_{i-1} a_i. \quad (10.80)$$

This is a sparse matrix-by-sparse vector product which was discussed in Section 10.5. It is best performed as a linear combination of the columns of A_{i-1} which are sparse. The only difficulty with this implementation is that it requires both the row data structure of A and of its transpose. A standard way to handle this problem is by building a linked-list data structure for the transpose. There is a similar problem for accessing the transpose of L , as mentioned earlier. Therefore, two linked lists are needed: one for the L matrix and the other for the A matrix. These linked lists avoid the storage of an additional real array for the matrices involved and simplify the process of updating the matrix A when new rows are obtained. It is important to note that these linked lists are used only in the preprocessing phase and are discarded once the incomplete factorization terminates.

10.7.3 INCOMPLETE GRAM-SCHMIDT AND ILQ

Consider a general sparse matrix A and denote its rows by a_1, a_2, \dots, a_n . The (complete) LQ factorization of A is defined by

$$A = LQ,$$

where L is a lower triangular matrix and Q is unitary, i.e., $Q^T Q = I$. The L factor in the above factorization is identical with the Cholesky factor of the matrix $B = AA^T$. Indeed, if $A = LQ$ where L is a lower triangular matrix having positive diagonal elements, then

$$B = AA^T = LQQ^T L^T = LL^T.$$

The uniqueness of the Cholesky factorization with a factor L having positive diagonal elements shows that L is equal to the Cholesky factor of B . This relationship can be exploited to obtain preconditioners for the Normal Equations.

Thus, there are two ways to obtain the matrix L . The first is to form the matrix B explicitly and use a sparse Cholesky factorization. This requires forming the data structure of the matrix AA^T , which may be much denser than A . However, reordering techniques can be used to reduce the amount of work required to compute L . This approach is known as *symmetric squaring*.

A second approach is to use the Gram-Schmidt process. This idea may seem undesirable at first because of its poor numerical properties when orthogonalizing a large number of vectors. However, because the rows remain very sparse in the incomplete LQ factorization (to be described shortly), any given row of A will be orthogonal typically to most of the previous rows of Q . As a result, the Gram-Schmidt process is much less prone to numerical difficulties. From the data structure point of view, Gram-Schmidt is optimal because it does not require allocating more space than is necessary, as is the case with approaches based on symmetric squaring. Another advantage over symmetric squaring is the simplicity of the orthogonalization process and its strong similarity with the LU factorization. At every step, a given row is combined with previous rows and then normalized. The incomplete Gram-Schmidt procedure is modeled after the following algorithm.

ALGORITHM 10.13: LQ Factorization of A

1. For $i = 1, \dots, n$ Do:
 2. Compute $l_{ij} := (a_i, q_j)$, for $j = 1, 2, \dots, i - 1$,
 3. Compute $q_i := a_i - \sum_{j=1}^{i-1} l_{ij} q_j$, and $l_{ii} = \|q_i\|_2$
 4. If $l_{ii} := 0$ then Stop; else Compute $q_i := q_i / l_{ii}$.
 5. EndDo
-

If the algorithm completes, then it will result in the factorization $A = LQ$ where the rows of Q and L are the rows defined in the algorithm. To define an *incomplete* factorization, a *dropping* strategy similar to those defined for Incomplete LU factorizations must be incorporated. This can be done in very general terms as follows. Let P_L and P_Q be the chosen zero patterns for the matrices L , and Q , respectively. The only restriction on P_L is that

$$P_L \subset \{(i, j) \mid i \neq j\}.$$

As for P_Q , for each row there must be at least one nonzero element, i.e.,

$$\{j \mid (i, j) \in P_Q\} \neq \{1, 2, \dots, n\}, \quad \text{for } i = 1, \dots, n.$$

These two sets can be selected in various ways. For example, similar to ILUT, they can be determined dynamically by using a drop strategy based on the magnitude of the elements generated. As before, x_i denotes the i -th row of a matrix X and x_{ij} its (i, j) -th entry.

ALGORITHM 10.14: Incomplete Gram-Schmidt

1. For $i = 1, \dots, n$ Do:
 2. Compute $l_{ij} := (a_i, q_j)$, for $j = 1, 2, \dots, i - 1$,
 3. Replace l_{ij} by zero if $(i, j) \in P_L$
 4. Compute $q_i := a_i - \sum_{j=1}^{i-1} l_{ij}q_j$,
 5. Replace each $q_{ij}, j = 1, \dots, n$ by zero if $(i, j) \in P_Q$
 6. $l_{ii} := \|q_i\|_2$
 7. If $l_{ii} = 0$ then Stop; else compute $q_i := q_i/l_{ii}$.
 8. EndDo
-

We recognize in line 2 the same practical problem encountered in the previous section for IC(0) for the Normal Equations. It can be handled in the same manner. Therefore, the row structures of A , L , and Q are needed, as well as a linked list for the column structure of Q .

After the i -th step is performed, the following relation holds:

$$q_i = l_{ii}q_i + r_i = a_i - \sum_{j=1}^{i-1} l_{ij}q_j$$

or

$$a_i = \sum_{j=1}^i l_{ij}q_j + r_i \tag{10.81}$$

where r_i is the row of elements that have been dropped from the row q_i in line 5. The above equation translates into

$$A = LQ + R \tag{10.82}$$

where R is the matrix whose i -th row is r_i , and the notation for L and Q is as before.

The case where the elements in Q are not dropped, i.e., the case when P_Q is the empty set, is of particular interest. Indeed, in this situation, $R = 0$ and we have the exact relation $A = LQ$. However, Q is not unitary in general because elements are dropped from L . If at a given step $l_{ii} = 0$, then (10.81) implies that a_i is a linear combination of the rows q_1, \dots, q_{i-1} . Each of these q_k is, inductively, a linear combination of a_1, \dots, a_k . Therefore, a_i would be a linear combination of the previous rows, a_1, \dots, a_{i-1} which cannot be true if A is nonsingular. As a result, the following proposition can be stated.

PROPOSITION 10.8 *If A is nonsingular and $P_Q = \phi$, then the Algorithm 10.14 completes and computes an incomplete LQ factorization $A = LQ$, in which Q is nonsingular and L is a lower triangular matrix with positive elements.*

A major problem with the decomposition (10.82) is that the matrix Q is not orthogonal in general. In fact, nothing guarantees that it is even nonsingular unless Q is not dropped or the dropping strategy is made tight enough.

Because the matrix L of the *complete* LQ factorization of A is identical with the Cholesky factor of B , one might wonder why the IC(0) factorization of B does not always exist while the ILQ factorization seems to always exist. In fact, the relationship between ILQ and ICNE, i.e., the Incomplete Cholesky for $B = AA^T$, can lead to a more rigorous way of choosing a good pattern for ICNE, as is explained next.

We turn our attention to Modified Gram-Schmidt. The only difference is that the row q_j is updated immediately after an inner product is computed. The algorithm is described without dropping for Q for simplicity.

ALGORITHM 10.15: Incomplete Modified Gram-Schmidt

1. For $i = 1, \dots, n$ Do:
 2. $q_i := a_i$
 3. For $j = 1, \dots, i - 1$, Do:
 4. Compute $l_{ij} := \begin{cases} 0 & \text{if } (i, j) \in P_L \\ (q_i, q_j) & \text{otherwise} \end{cases}$
 5. Compute $q_i := q_i - l_{ij}q_j$.
 6. EndDo
 7. $l_{ii} := \|q_i\|_2$
 8. If $l_{ii} = 0$ then Stop; else Compute $q_i := q_i/l_{ii}$.
 9. EndDo
-

When A is nonsingular, the same result as before is obtained if no dropping is used on Q , namely, that the factorization will exist and be exact in that $A = LQ$. Regarding the implementation, if the zero pattern P_L is known in advance, the computation of the inner products in line 4 does not pose a particular problem. Without any dropping in Q , this algorithm may be too costly in terms of storage. It is interesting to see that this algorithm has a connection with ICNE, the incomplete Cholesky applied to the matrix AA^T . The following result is stated without proof.

THEOREM 10.5 *Let A be an $n \times m$ matrix and let $B = AA^T$. Consider a zero-pattern set P_L which is such that for any $1 \leq i, j, k \leq n$, with $i < j$ and $i < k$, the following holds:*

$$(i, j) \in P_L \text{ and } (i, k) \notin P_L \rightarrow (j, k) \in P_L.$$

Then the matrix L obtained from Algorithm 10.15 with the zero-pattern set P_L is identical with the L factor that would be obtained from the Incomplete Cholesky factorization applied to B with the zero-pattern set P_L .

For a proof, see [222]. This result shows how a zero-pattern can be defined which guarantees the existence of an Incomplete Cholesky factorization on AA^T .

EXERCISES

1. Assume that A is the Symmetric Positive Definite matrix arising from the 5-point finite difference discretization of the Laplacean on a given mesh. We reorder the matrix using the red-black ordering and obtain the reordered matrix

$$B = \begin{pmatrix} D_1 & E \\ E^T & D_2 \end{pmatrix}.$$

We then form the Incomplete Cholesky factorization on this matrix.

- a. Show the fill-in pattern for the IC(0) factorization for a matrix of size $n = 12$ associated with a 4×3 mesh.
 - b. Show the nodes associated with these fill-ins on the 5-point stencil in the finite difference mesh.
 - c. Give an approximate count of the total number of fill-ins when the original mesh is square, with the same number of mesh points in each direction. How does this compare with the natural ordering? Any conclusions?
2. Consider a 6×6 tridiagonal nonsingular matrix A .

- a. What can be said about its ILU(0) factorization (when it exists)?
- b. Suppose that the matrix is permuted (symmetrically, i.e., both rows and columns) using the permutation

$$\pi = [1, 3, 5, 2, 4, 6].$$

- i. Show the pattern of the permuted matrix.
 - ii. Show the locations of the fill-in elements in the ILU(0) factorization.
 - iii. Show the pattern of the ILU(1) factorization as well as the fill-ins generated.
 - iv. Show the level of fill of each element at the end of the ILU(1) process (including the fill-ins).
 - v. What can be said of the ILU(2) factorization for this permuted matrix?
3. Assume that A is the matrix arising from the 5-point finite difference discretization of an elliptic operator on a given mesh. We reorder the original linear system using the red-black ordering and obtain the reordered linear system

$$\begin{pmatrix} D_1 & E \\ F & D_2 \end{pmatrix} \begin{pmatrix} x_1 \\ x_2 \end{pmatrix} = \begin{pmatrix} b_1 \\ b_2 \end{pmatrix}.$$

- a. Show how to obtain a system (called the *reduced system*) which involves the variable x_2 only.
 - b. Show that this reduced system is also a sparse matrix. Show the stencil associated with the reduced system matrix on the original finite difference mesh and give a graph-theory interpretation of the reduction process. What is the maximum number of nonzero elements in each row of the reduced system.
4. It was stated in Section 10.3.2 that for some specific matrices the ILU(0) factorization of A can be put in the form

$$M = (D - E)D^{-1}(D - F)$$

in which $-E$ and $-F$ are the strict-lower and -upper parts of A , respectively.

- a. Characterize these matrices carefully and give an interpretation with respect to their adjacency graphs.
 - b. Verify that this is true for standard 5-point matrices associated with any domain Ω .
 - c. Is it true for 9-point matrices?
 - d. Is it true for the higher level ILU factorizations?
5. Let A be a pentadiagonal matrix having diagonals in offset positions $-m, -1, 0, 1, m$. The coefficients in these diagonals are all constants: a for the main diagonal and -1 for all others. It is assumed that $a \geq \sqrt{8}$. Consider the ILU(0) factorization of A as given in the form (10.20). The elements d_i of the diagonal D are determined by a recurrence of the form (10.19).
 - a. Show that $\frac{a}{2} \leq d_i \leq a$ for $i = 1, \dots, n$.
 - b. Show that d_i is a decreasing sequence. [Hint: Use induction].
 - c. Prove that the formal (infinite) sequence defined by the recurrence converges. What is its limit?
 6. Consider a matrix A which is split in the form $A = D_0 - E - F$, where D_0 is a block diagonal matrix whose block-diagonal entries are the same as those of A , and where $-E$ is strictly lower triangular and $-F$ is strictly upper triangular. In some cases the block form of the ILU(0) factorization can be put in the form (Section 10.3.2):

$$M = (D - E)D^{-1}(D - F).$$

The block entries of D can be defined by a simple matrix recurrence. Find this recurrence relation. The algorithm may be expressed in terms of the block entries the matrix A .

7. Generalize the formulas developed at the end of Section 10.6.1 for the inverses of symmetric tridiagonal matrices, to the nonsymmetric case.
8. Develop recurrence relations for Incomplete Cholesky with no fill-in (IC(0)), for 5-point matrices, similar to those seen in Section 10.3.4 for ILU(0). Same question for IC(1).
9. What becomes of the formulas seen in Section 10.3.4 in the case of a 7-point matrix (for three-dimensional problems)? In particular, can the ILU(0) factorization be cast in the form (10.20) in which $-E$ is the strict-lower diagonal of A and $-F$ is the strict upper triangular part of A , and D is a certain diagonal?
10. Consider an arbitrary matrix A which is split in the usual manner as $A = D_0 - E - F$, in which $-E$ and $-F$ are the strict-lower and -upper parts of A , respectively, and define, for any diagonal matrix D , the approximate factorization of A given by

$$M = (D - E)D^{-1}(D - F).$$

Show how a diagonal D can be determined such that A and M have the same diagonal elements. Find a recurrence relation for the elements of D . Consider now the symmetric case and assume that the matrix D which is positive can be found. Write M in the form

$$M = (D^{1/2} - ED^{-1/2})(D^{1/2} - ED^{-1/2})^T \equiv L_1 L_1^T.$$

What is the relation between this matrix and the matrix of the SSOR(ω) preconditioning, in the particular case when $D^{-1/2} = \omega I$? Conclude that this form of ILU factorization is in effect an SSOR preconditioning with a different relaxation factor ω for each equation.

11. Consider a general sparse matrix A (irregularly structured). We seek an approximate LU factorization of the form

$$M = (D - E)D^{-1}(D - F)$$

in which $-E$ and $-F$ are the strict-lower and -upper parts of A , respectively. It is assumed that A is such that

$$a_{ii} > 0, \quad a_{ij}a_{ji} \geq 0 \quad \text{for } i, j = 1, \dots, n.$$

- a. By identifying the diagonal elements of A with those of M , derive an algorithm for generating the elements of the diagonal matrix D recursively.
- b. Establish that if $d_j > 0$ for $j < i$ then $d_i \leq a_{ii}$. Is it true in general that $d_j > 0$ for all j ?
- c. Assume that for $i = 1, \dots, j-1$ we have $d_i \geq \alpha > 0$. Show a sufficient condition under which $d_j \geq \alpha$. Are there cases in which this condition cannot be satisfied for any α ?
- d. Assume now that all diagonal elements of A are equal to a constant, i.e., $a_{jj} = a$ for $j = 1, \dots, n$. Define $\alpha \equiv \frac{a}{2}$ and let

$$S_j \equiv \sum_{i=1}^{j-1} a_{ij}a_{ji}, \quad \sigma \equiv \max_{j=1, \dots, n} S_j.$$

Show a condition on σ under which $d_j \geq \alpha$, $j = 1, 2, \dots, n$.

12. Show the second part of (10.79). [Hint: Exploit the formula $AB^T = \sum_{j=1}^n a_j b_j^T$ where a_j, b_j are the j -th columns of A and B , respectively].
13. Let a preconditioning matrix M be related to the original matrix A by $M = A + E$, in which E is a matrix of rank k .
 - a. Assume that both A and M are Symmetric Positive Definite. How many steps at most are required for the preconditioned Conjugate Gradient method to converge when M is used as a preconditioner?
 - b. Answer the same question for the case when A and M are nonsymmetric and the full GMRES is used on the preconditioned system.
14. Formulate the problem for finding an approximate inverse M to a matrix A as a large $n^2 \times n^2$ linear system. What is the Frobenius norm in the space in which you formulate this problem?
15. The concept of *mask* is useful in the global iteration technique. For a sparsity pattern S , i.e., a set of pairs (i, j) and a matrix B , we define the product $C = B \odot S$ to be the matrix whose elements c_{ij} are zero if (i, j) does not belong to S , and b_{ij} otherwise. This is called a mask operation since its effect is to ignore every value not in the pattern S . Consider a global minimization of the function $F_S(M) \equiv \|S \odot (I - AM)\|_F$.
 - a. What does the result of Proposition 10.3 become for this new objective function?
 - b. Formulate an algorithm based on a global masked iteration, in which the mask is fixed and equal to the pattern of A .
 - c. Formulate an algorithm in which the mask is adapted at each outer step. What criteria would you use to select the mask?
16. Consider the global self preconditioned MR iteration algorithm seen in Section 10.5.5. Define the acute angle between two matrices as

$$\cos \angle(X, Y) \equiv \frac{\langle X, Y \rangle}{\|X\|_F \|Y\|_F}.$$

- a. Following what was done for the (standard) Minimal Residual algorithm seen in Chapter 5, establish that the matrices $B_k = AM_k$ and $R_k = I - B_k$ produced by global MR without dropping are such that

$$\|R_{k+1}\|_F \leq \|R_k\|_F \sin \angle(R_k, B_k R_k).$$

- b.** Let now $M_0 = \alpha A^T$ so that B_k is symmetric for all k (see Section 10.5.5). Assume that, at a given step k the matrix B_k is positive definite. Show that

$$\cos \angle(R_k, B_k R_k) \geq \frac{\lambda_{\min}(B_k)}{\lambda_{\max}(B_k)}$$

in which $\lambda_{\min}(B_k)$ and $\lambda_{\max}(B_k)$ are, respectively, the smallest and largest eigenvalues of B_k .

- 17.** In the two-sided version of approximate inverse preconditioners, the option of minimizing

$$f(L, U) = \|I - LAU\|_F^2$$

was mentioned, where L is unit lower triangular and U is upper triangular.

- a.** What is the gradient of $f(L, U)$?
- b.** Formulate an algorithm based on minimizing this function globally.
- 18.** Consider the two-sided version of approximate inverse preconditioners, in which a unit lower triangular L and an upper triangular U are sought so that $LAU \approx I$. One idea is to use an alternating procedure in which the first half-step computes a right approximate inverse U to LA , which is restricted to be upper triangular, and the second half-step computes a left approximate inverse L to AU , which is restricted to be lower triangular.
- a.** Consider the first half-step. Since the candidate matrix U is restricted to be upper triangular, special care must be exercised when writing a column-oriented approximate inverse algorithm. What are the differences with the standard MR approach described by Algorithm 10.10?
- b.** Now consider seeking an upper triangular matrix U such that the matrix $(LA)U$ is close to the identity only in its upper triangular part. A similar approach is to be taken for the second half-step. Formulate an algorithm based on this approach.
- 19.** Write all six variants of the preconditioned Conjugate Gradient algorithm applied to the Normal Equations, mentioned at the end of Section 10.7.1.
- 20.** With the standard splitting $A = D - E - F$, in which D is the diagonal of A and $-E, -F$ its lower- and upper triangular parts, respectively, we associate the factored approximate inverse factorization,

$$(I + ED^{-1})A(I + D^{-1}F) = D + R. \quad (10.83)$$

- a.** Determine R and show that it consists of second order terms, i.e., terms involving products of at least two matrices from the pair E, F .
- b.** Now use the previous approximation for $D + R \equiv D_1 - E_1 - F_1$,

$$(I + E_1 D_1^{-1})(D + R)(I + D_1^{-1} F_1) = D_1 + R_1.$$

Show how the approximate inverse factorization (10.83) can be improved using this new approximation. What is the order of the resulting approximation?

NOTES AND REFERENCES. A breakthrough paper on preconditioners is the article [149] by Meijerink and van der Vorst who established existence of the incomplete factorization for M -matrices and showed that preconditioning the Conjugate Gradient by using an ILU factorization can result in an extremely efficient combination. The idea of preconditioning was exploited in many earlier papers. For example, in [11, 12] Axelsson discusses SSOR iteration, “accelerated” by either the Conjugate

Gradient or Chebyshev acceleration. Incomplete factorizations were also discussed in early papers, for example, by Varga [212] and Buleev [45]. Thus, Meijerink and van der Vorst's paper played an essential role in directing the attention of researchers and practitioners to a rather important topic and marked a turning point. Many of the early techniques were developed for regularly structured matrices. The generalization, using the definition of level of fill for high-order Incomplete LU factorizations for unstructured matrices, was introduced by Watts [223] for petroleum engineering problems.

Recent research on iterative techniques has been devoted in great part to the development of better iterative accelerators, while "robust" preconditioners have by and large been neglected. This is certainly caused by the inherent lack of theory to support such methods. Yet these techniques are vital to the success of iterative methods in real-life applications. A general approach based on modifying a given direct solver by including a drop-off rule was one of the first in this category [151, 157, 235, 98]. More economical alternatives, akin to $ILU(p)$, were developed later [179, 183, 68, 67, 226, 233]. ILUT and ILUTP, are inexpensive general purpose preconditioners which are fairly robust and efficient. However, many of these preconditioners, including ILUT and ILUTP, can fail. Occasionally, a more accurate ILUT factorization leads to a larger number of steps needed for convergence. One source of failure is the instability of the preconditioning operation. These phenomena of instability have been studied by Elman [81] who proposed a detailed analysis of ILU and MILU preconditioners for model problems. The theoretical analysis on ILUT stated as Theorem 10.3 is modeled after Theorem 1.14 in Axelsson and Barker [16] for $ILU(0)$.

Some theory for block preconditioners is discussed in Axelsson's book [15]. Different forms of block preconditioners were developed independently by Axelsson, Brinkkemper, and Il'in [17] and by Concus, Golub, and Meurant [61], initially for block matrices arising from PDEs in two dimensions. Later, some generalizations were proposed [137]. Thus, the 2-level implicit-explicit preconditioning introduced in [137] consists of using sparse inverse approximations to Δ_i^{-1} for obtaining Ω_i .

The current rebirth of approximate inverse preconditioners [112, 62, 137, 54] is spurred by both parallel processing and robustness considerations. Other preconditioners which are not covered here are those based on domain decomposition techniques. Some of these techniques will be reviewed in Chapter 13.

On another front, there is also increased interest in methods that utilize Normal Equations in one way or another. Earlier, ideas revolved around shifting the matrix $B = A^T A$ before applying the IC(0) factorization as was suggested by Kershaw [134] in 1977. Manteuffel [148] also made some suggestions on how to select a good α in the context of the CGW algorithm. Currently, new ways of exploiting the relationship with the QR (or LQ) factorization to define IC(0) more rigorously are being explored; see the recent work in [222]. ■

PARALLEL IMPLEMENTATIONS

Parallel computing is fast becoming an inexpensive alternative to the standard supercomputer approach for solving large scale problems that arise in scientific and engineering applications. Since iterative methods are appealing for large linear systems of equations, it is no surprise that they are the prime candidates for implementations on parallel architectures. There have been two traditional approaches for developing parallel iterative techniques thus far. The first extracts parallelism whenever possible from standard algorithms. The advantage of this viewpoint is that it is easier to understand in general since the underlying method has not changed from its sequential equivalent. The second approach is to develop alternative algorithms which have enhanced parallelism. This chapter will give an overview of implementations and will emphasize methods in the first category. The later chapters will consider alternative algorithms that have been developed specifically for parallel computing environments.

INTRODUCTION

11.1

The remaining chapters of this book will examine the impact of high performance computing on the design of iterative methods for solving large linear systems of equations. Because of the increased importance of three-dimensional models combined with the high cost associated with sparse direct methods for solving these problems, iterative techniques are starting to play a major role in many application areas. The main appeal of iterative methods is their low storage requirement. Another advantage is that they are far easier to implement on parallel computers than sparse direct methods because they only require a rather small set of computational kernels. Increasingly, direct solvers are being used in conjunction with iterative solvers to develop robust preconditioners.

The first considerations for high-performance implementations of iterative methods involved implementations on vector computers. These efforts started in the mid 1970s when the first vector computers appeared. Currently, there is a larger effort to develop new prac-

tical iterative methods that are not only efficient in a parallel environment, but also robust. Often, however, these two requirements seem to be in conflict.

This chapter begins with a short overview of the various ways in which parallelism has been exploited in the past and a description of the current architectural models for existing commercial parallel computers. Then, the basic computations required in Krylov subspace methods will be discussed along with their implementations.

FORMS OF PARALLELISM

11.2

Parallelism has been exploited in a number of different forms since the first computers were built. The six major forms of parallelism are: (1) multiple functional units; (2) pipelining; (3) vector processing; (4) multiple vector pipelines; (5) multiprocessing; and (6) distributed computing. Next is a brief description of each of these approaches.

11.2.1 MULTIPLE FUNCTIONAL UNITS

This is one of the earliest forms of parallelism. It consists of multiplying the number of functional units such as adders and multipliers. Thus, the control units and the registers are shared by the functional units. The detection of parallelism is done at compilation time with a “Dependence Analysis Graph,” an example of which is shown in Figure 11.1.

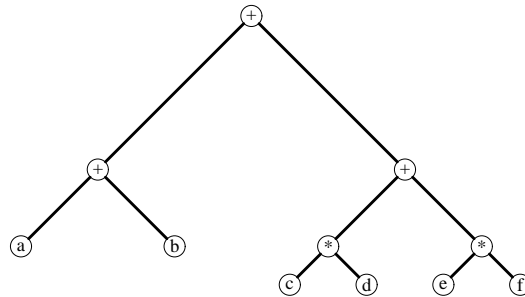
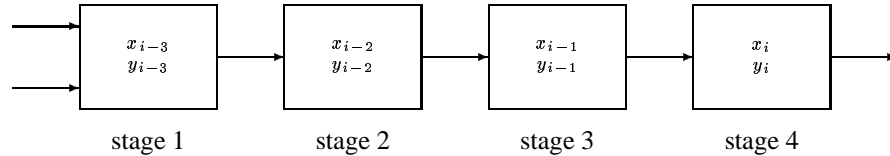

Figure 11.1 *Dependence analysis for arithmetic expression:*
 $(a + b) + (c * d + d * e)$.

In the example of Figure 11.1, the two multiplications can be performed simultaneously, then the two additions in the middle are performed simultaneously. Finally, the addition at the root is performed.

11.2.2 PIPELINING

The pipelining concept is essentially the same as that of an assembly line used in car manufacturing. Assume that an operation takes s stages to complete. Then the operands can be passed through the s stages instead of waiting for all stages to be completed for the first two operands.



If each stage takes a time τ to complete, then an operation with n numbers will take the time $s\tau + (n - 1)\tau = (n + s - 1)\tau$. The speed-up would be the ratio of the time to complete the s stages in a non-pipelined unit versus, i.e., $s \times n \times \tau$, over the above obtained time,

$$S = \frac{ns}{n + s - 1}.$$

For large n , this would be close to s .

11.2.3 VECTOR PROCESSORS

Vector computers appeared in the beginning of the 1970s with the CDC Star 100 and then the CRAY-1 and Cyber 205. These are computers which are equipped with vector pipelines, i.e., pipelined functional units, such as a pipelined floating-point adder, or a pipelined floating-point multiplier. In addition, they incorporate vector instructions explicitly as part of their instruction sets. Typical vector instructions are, for example:

VLOAD	To load a vector from memory to a vector register
VADD	To add the content of two vector registers
VMUL	To multiply the content of two vector registers.

Similar to the case of multiple functional units for scalar machines, vector pipelines can be duplicated to take advantage of any fine grain parallelism available in loops. For example, the Fujitsu and NEC computers tend to obtain a substantial portion of their performance in this fashion. There are many vector operations that can take advantage of *multiple vector pipelines*.

11.2.4 MULTIPROCESSING AND DISTRIBUTED COMPUTING

A multiprocessor system is a computer, or a set of several computers, consisting of several processing elements (PEs), each consisting of a CPU, a memory, an I/O subsystem, etc. These PEs are connected to one another with some communication medium, either a bus or some multistage network. There are numerous possible configurations, some of which will be covered in the next section.

Distributed computing is a more general form of multiprocessing, in which the processors are actually computers linked by some Local Area Network. Currently, there are a number of libraries that offer communication mechanisms for exchanging messages between Unix-based systems. The best known of these are the Parallel Virtual Machine (PVM) and the Message Passing Interface (MPI). In heterogeneous networks of computers, the processors are separated by relatively large distances and that has a negative impact on the performance of distributed applications. In fact, this approach is cost-effective only for large applications, in which a high volume of computation can be performed before more data is to be exchanged.

TYPES OF PARALLEL ARCHITECTURES

11.3

There are currently three leading architecture models. These are:

- The shared memory model.
- SIMD or data parallel models.
- The distributed memory message passing model.

A brief overview of the characteristics of each of the three groups follows. Emphasis is on the possible effects these characteristics have on the implementations of iterative methods.

11.3.1 SHARED MEMORY COMPUTERS

A shared memory computer has the processors connected to a large global memory with the same global view, meaning the address space is the same for all processors. One of the main benefits of shared memory models is that access to data depends very little on its location in memory. In a shared memory environment, transparent data access facilitates programming to a great extent. From the user's point of view, data are stored in a large global memory that is readily accessible to any processor. However, memory conflicts as well as the necessity to maintain data coherence can lead to degraded performance. In addition, shared memory computers cannot easily take advantage of data locality in problems which have an intrinsically local nature, as is the case with most discretized PDEs. Some current machines have a physically distributed memory but they are logically shared, i.e., each processor has the same view of the global address space.

There are two possible implementations of shared memory machines: (1) bus-based architectures, and (2) switch-based architecture. These two model architectures are illustrated in Figure 11.2 and Figure 11.3, respectively. So far, shared memory computers have been implemented more often with buses than with switching networks.

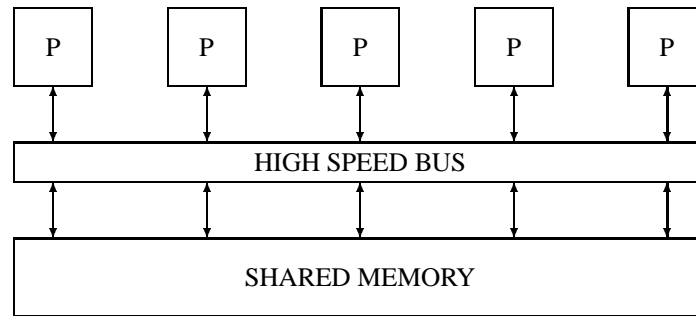

Figure 11.2 A bus-based shared memory computer.

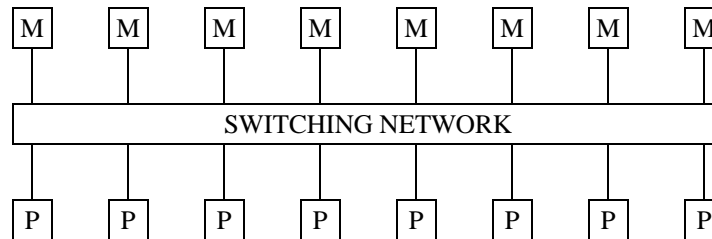

Figure 11.3 A switch-based shared memory computer.

Buses are the backbone for communication between the different units of most computers. Physically, a bus is nothing but a bundle of wires, made of either fiber or copper. These wires carry information consisting of data, control signals, and error correction bits. The speed of a bus, often measured in Megabytes per second and called the *bandwidth* of the bus, is determined by the number of lines in the bus and the clock rate. Often, the limiting factor for parallel computers based on bus architectures is the bus bandwidth rather than the CPU speed.

The primary reason why bus-based multiprocessors are more common than switch-based ones is that the hardware involved in such implementations is simple. On the other hand, the difficulty with bus-based machines is that the number of processors which can be connected to the memory will be small in general. Typically, the bus is timeshared, meaning slices of time are allocated to the different clients (processors, IO processors, etc.) that request its use.

In a multiprocessor environment, the bus can easily be saturated. Several remedies are possible. The first, and most common, remedy is to attempt to reduce traffic by adding *local memories* or *caches* attached to each processor. Since a data item used by a given processor is likely to be reused by the same processor in the next instructions, storing the data item in local memory will help reduce traffic in general. However, this strategy causes some difficulties due to the requirement to maintain *data coherence*. If Processor (A) reads some data from the shared memory, and Processor (B) modifies the same data in shared memory, immediately after, the result is two copies of the same data that have different values. A mechanism should be put in place to ensure that the most recent update of the data is always used. The additional overhead incurred by such memory coherence

operations may well offset the savings involving memory traffic.

The main features here are the switching network and the fact that a global memory is shared by all processors through the switch. There can be p processors on one side connected to p memory units or banks on the other side. Alternative designs based on switches connect p processors to each other instead of p memory banks. The switching network can be a crossbar switch when the number of processors is small. A crossbar switch is analogous to a telephone switch board and allows p inputs to be connected to m outputs without conflict. Since crossbar switches for large numbers of processors are typically expensive they are replaced by multistage networks. Signals travel across a small number of stages consisting of an array of elementary switches, e.g., 2×2 or 4×4 switches.

There have been two ways of exploiting multistage networks. In *circuit switching* networks, the elementary switches are set up by sending electronic signals across all of the switches. The circuit is set up once in much the same way that telephone circuits are switched in a switchboard. Once the switch has been set up, communication between processors P_1, \dots, P_n is open to the memories

$$M_{\pi_1}, M_{\pi_2}, \dots, M_{\pi_n},$$

in which π represents the desired permutation. This communication will remain functional for as long as it is not reset. Setting up the switch can be costly, but once it is done, communication can be quite fast. In *packet switching* networks, a packet of data will be given an address token and the switching within the different stages will be determined based on this address token. The elementary switches have to provide for buffering capabilities, since messages may have to be queued at different stages.

11.3.2 DISTRIBUTED MEMORY ARCHITECTURES

The *distributed memory* model refers to the distributed memory *message passing* architectures as well as to distributed memory SIMD computers. A typical distributed memory system consists of a large number of identical processors which have their own memories and which are interconnected in a regular topology. Examples are depicted in Figures 11.4 and 11.5. In these diagrams, each processor unit can be viewed actually as a complete processor with its own memory, CPU, I/O subsystem, control unit, etc. These processors are linked to a number of “neighboring” processors which in turn are linked to other neighboring processors, etc. In “Message Passing” models there is no global synchronization of the parallel tasks. Instead, computations are *data driven* because a processor performs a given task only when the operands it requires become available. The programmer must program all the data exchanges explicitly between processors.

In SIMD designs, a different approach is used. A host processor stores the program and each slave processor holds different data. The host then broadcasts instructions to processors which execute them simultaneously. One advantage of this approach is that there is no need for large memories in each node to store large programs since the instructions are broadcast one by one to all processors.

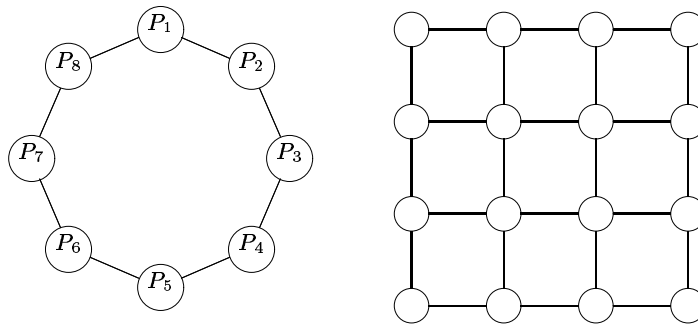

Figure 11.4 An eight-processor ring (left) and a 4×4 multi-processor mesh (right).

An important advantage of distributed memory computers is their ability to exploit locality of data in order to keep communication costs to a minimum. Thus, a two-dimensional processor grid such as the one depicted in Figure 11.4 is perfectly suitable for solving discretized elliptic Partial Differential Equations (e.g., by assigning each grid point to a corresponding processor) because some iterative methods for solving the resulting linear systems will require only interchange of data between adjacent grid points.

A good general purpose multiprocessor must have powerful *mapping capabilities* because it should be capable of easily emulating many of the common topologies such as 2-D and 3-D grids or linear arrays, FFT-butterflies, finite element meshes, etc.

Three-dimensional configurations are also popular. A massively parallel commercial computer based on a 3-D mesh, called T3D, is marketed by CRAY Research, Inc. For 2-D and 3-D grids of processors, it is common that processors on each side of the grid are connected to those on the opposite side. When these “wrap-around” connections are included, the topology is sometimes referred to as a torus.

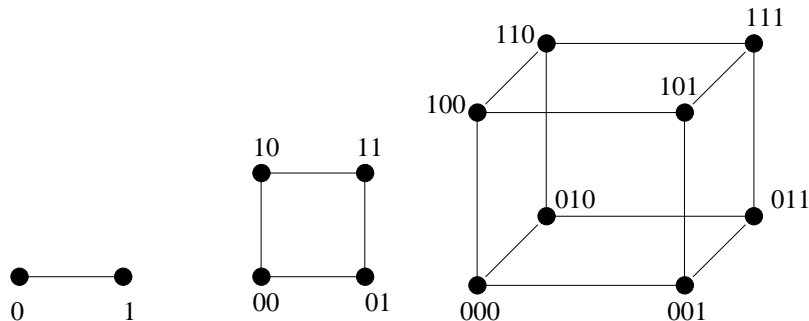

Figure 11.5 The n -cubes of dimensions $n = 1, 2, 3$.

Hypercubes are highly concurrent multiprocessors based on the binary n -cube topology which is well known for its rich interconnection capabilities. A parallel processor based on the n -cube topology, called a *hypercube* hereafter, consists of 2^n identical processors, interconnected with n neighbors. A 3-cube can be represented as an ordinary cube

in three dimensions where the vertices are the $8 = 2^3$ nodes of the 3-cube; see Figure 11.5. More generally, one can construct an n -cube as follows: First, the 2^n nodes are labeled by the 2^n binary numbers from 0 to $2^n - 1$. Then a link between two nodes is drawn if and only if their binary numbers differ by one (and only one) bit.

The first property of an n -cube graph is that it can be constructed recursively from lower dimensional cubes. More precisely, consider two identical $(n - 1)$ -cubes whose vertices are labeled likewise from 0 to 2^{n-1} . By joining every vertex of the first $(n - 1)$ -cube to the vertex of the second having the same number, one obtains an n -cube. Indeed, it suffices to renumber the nodes of the first cube as $0 \wedge a_i$ and those of the second as $1 \wedge a_i$ where a_i is a binary number representing the two similar nodes of the $(n - 1)$ -cubes and where \wedge denotes the concatenation of binary numbers.

Separating an n -cube into the subgraph of all the nodes whose leading bit is 0 and the subgraph of all the nodes whose leading bit is 1, the two subgraphs are such that each node of the first is connected to one node of the second. If the edges between these two graphs is removed, the result is 2 disjoint $(n - 1)$ -cubes. Moreover, generally, for a given numbering, the graph can be separated into two subgraphs obtained by considering all the nodes whose i^{th} bit is 0 and those whose i^{th} bit is 1. This will be called tearing along the i^{th} direction. Since there are n bits, there are n directions. One important consequence of this is that arbitrary meshes with dimension $\leq n$ can be mapped on hypercubes. However, the hardware cost for building a hypercube is high, because each node becomes difficult to design for larger dimensions. For this reason, recent commercial vendors have tended to prefer simpler solutions based on two- or three-dimensional meshes.

Distributed memory computers come in two different designs, namely, SIMD and MIMD. Many of the early projects have adopted the SIMD organization. For example, the historical ILLIAC IV Project of the University of Illinois was a machine based on a mesh topology where all processors execute the same instructions.

SIMD distributed processors are sometimes called array processors because of the regular arrays that they constitute. In this category, systolic arrays can be classified as an example of distributed computing. Systolic arrays are distributed memory computers in which each processor is a cell which is programmed (possibly micro-coded) to perform only one of a few operations. All the cells are synchronized and perform the same task. Systolic arrays are designed in VLSI technology and are meant to be used for special purpose applications, primarily in signal processing.

TYPES OF OPERATIONS

11.4

Now consider two prototype Krylov subspace techniques, namely, the preconditioned Conjugate Gradient method for the symmetric case and the preconditioned GMRES algorithm for the nonsymmetric case. For each of these two techniques, we analyze the types of operations that are performed. It should be emphasized that other Krylov subspace techniques require similar operations.

11.4.1 PRECONDITIONED CG

Consider Algorithm 9.1. The first step when implementing this algorithm on a high-performance computer is identifying the main operations that it requires. We distinguish five types of operations, which are:

1. Preconditioner setup.
2. Matrix vector multiplications.
3. Vector updates.
4. Dot products.
5. Preconditioning operations.

In the above list the potential bottlenecks are (1), setting up the preconditioner and (5), solving linear systems with M , i.e., the preconditioning operation. Section 11.6 discusses the implementation of traditional preconditioners, and the last two chapters are devoted to preconditioners that are specialized to parallel environments. Next come the matrix-by-vector products which deserve particular attention. The rest of the algorithm consists essentially of dot products and vector updates which do not cause significant difficulties in parallel machines, although inner products can lead to some loss of efficiency on certain types of computers with large numbers of processors.

11.4.2 GMRES

The only new operation here with respect to the Conjugate Gradient method is the orthogonalization of the vector Av_i against the previous v 's. The usual way to accomplish this is via the modified Gram-Schmidt process, which is basically a sequence of subprocesses of the form:

- Compute $\alpha = (y, v)$.
- Compute $\hat{y} := y - \alpha v$.

This orthogonalizes a vector y against another vector v of norm one. Thus, the outer loop of the modified Gram-Schmidt is sequential, but the inner loop, i.e., each subprocess, can be parallelized by dividing the inner product and SAXPY operations among processors. Although this constitutes a perfectly acceptable approach for a small number of processors, the elementary subtasks may be too small to be efficient on a large number of processors. An alternative for this case is to use a standard Gram-Schmidt process with reorthogonalization. This replaces the previous sequential orthogonalization process by a matrix operation of the form $\hat{y} = y - VV^T y$, i.e., BLAS-1 kernels are replaced by BLAS-2 kernels.

Recall that the next level of BLAS, i.e., level 3 BLAS, exploits blocking in dense matrix operations in order to obtain performance on machines with hierarchical memories. Unfortunately, level 3 BLAS kernels cannot be exploited here because at every step, there is only one vector to orthogonalize against all previous ones. This may be remedied by using block Krylov methods.

11.4.3 VECTOR OPERATIONS

These are usually the simplest operations to implement on any computer. In many cases, compilers are capable of recognizing them and invoking the appropriate machine instructions, possibly vector instructions. In the specific case of CG-like algorithms, there are two types of operations: vector updates and dot products.

Vector Updates Operations of the form

$$y(1:n) = y(1:n) + a * x(1:n),$$

where a is a scalar and y and x two vectors, are known as *vector updates* or SAXPY operations. They are typically straightforward to implement in all three machine models discussed earlier. On an SIMD computer, the above code segment can be used on many of the recent systems and the compiler will translate it into the proper parallel version. The above line of code is written in FORTRAN 90, which is the prototype programming language for this type of computers. On shared memory computers, we can simply write the usual FORTRAN loop, possibly in the above FORTRAN 90 style on some computers, and the compiler will translate it again in the appropriate parallel executable code.

On distributed memory computers, some assumptions must be made about the way in which the vectors are distributed. The main assumption is that the vectors x and y are distributed in the same manner among the processors, meaning the indices of the components of any vector that are mapped to a given processor are the same. In this case, the vector-update operation will be translated into p independent vector updates, requiring no communication. Specifically, if $nloc$ is the number of variables local to a given processor, this processor will simply execute a vector loop of the form

$$y(1:nloc) = y(1:nloc) + a * x(1:nloc)$$

and all processors will execute a similar operation simultaneously.

Dot products A number of operations use all the components of a given vector to compute a single floating-point result which is then needed by all processors. These are termed *Reduction Operations* and the dot product is the prototype example. A distributed version of the dot-product is needed to compute the inner product of two vectors x and y that are distributed the same way across the processors. In fact, to be more specific, this distributed dot-product operation should compute the inner product $t = x^T y$ of these two vectors and then make the result t available in each processor. Typically, this result is needed to perform vector updates or other operations in each node. For a large number of processors, this sort of operation can be demanding in terms of communication costs. On the other hand, parallel computer designers have become aware of their importance and are starting to provide hardware and software support for performing *global reduction operations* efficiently. Reduction operations that can be useful include global sums, global max/min calculations, etc. A commonly adopted convention provides a single subroutine for all these operations, and passes the type of operation to be performed (add, max, min, multiply, . . .) as one of the arguments. With this in mind, a distributed dot-product function can be programmed roughly as follows.

```

function distdot(nloc, x, incx, y, incy)
  integer nloc
  real*8 x(nloc), y(nloc)
  tloc = DDOT (nloc, x, incx, y, incy)
  distdot = REDUCE(tloc, 'add')
end

```

The function DDOT performs the usual BLAS-1 dot product of x and y with strides $incx$ and $incy$, respectively. The REDUCE operation, which is called with “add” as the operation-type parameter, sums all the variables “tloc” from each processor and put the resulting global sum in the variable *distdot* in each processor.

11.4.4 REVERSE COMMUNICATION

To conclude this section, the following important observation can be made regarding the practical implementation of Krylov subspace accelerators, such as PCG or GMRES. The only operations that involve communication are the dot product, the matrix-by-vector product, and, potentially, the preconditioning operation. There is a mechanism for delegating the last two operations to a calling program, outside of the Krylov accelerator. The result of this is that the Krylov acceleration routine will be free of any matrix data structures as well as communication calls. This makes the Krylov routines portable, except for the possible redefinition of the inner product *distdot*.

This mechanism, particular to FORTRAN programming, is known as *reverse communication*. Whenever a matrix-by-vector product or a preconditioning operation is needed, the subroutine is exited and the calling program unit performs the desired operation. Then the subroutine is called again, after placing the desired result in one of its vector arguments.

A typical execution of a flexible GMRES routine with reverse communication is shown in the code segment below. The integer parameter *icode* indicates the type of operation needed by the subroutine. When *icode* is set to one, then a preconditioning operation must be applied to the vector $wk1$. The result is copied in $wk2$ and FGMRES is called again. If it is equal to two, then the vector $wk1$ must be multiplied by the matrix A . The result is then copied in $wk2$ and FGMRES is called again.

```

  icode = 0
1  continue
  call fgmres (n,im,rhs,sol,i,vv,w,wk1, wk2,eps,
*           maxits,iout,icode)
  if (icode .eq. 1) then
    call precon(n, wk1, wk2) ! user's preconditioner
    goto 1
  else if (icode .eq. 2) then
    call matvec (n,wk1, wk2) ! user's matvec
    goto 1
  endif

```

Reverse communication enhances the flexibility of the FGMRES routine substantially. For example, when changing preconditioners, we can iterate on a coarse mesh and do the

necessary interpolations to get the result in $wk2$ in a given step and then iterate on the fine mesh in the following step. This can be done without having to pass any data regarding the matrix or the preconditioner to the FGMRES accelerator.

Note that the purpose of reverse communication simply is to avoid passing data structures related to the matrices, to the accelerator FGMRES. The problem is that these data structures are not fixed. For example, it may be desirable to use different storage formats for different architectures. A more elegant solution to this problem is *Object-Oriented Programming*. In Object-Oriented Programming languages such as C++, a class can be declared, e.g., a class of sparse matrices, and operators can be defined on them. Data structures are not passed to these operators. Instead, the implementation will recognize the types of the operands and invoke the proper functions. This is similar to what exists currently for arithmetic. For operation $s = z + y$, the compiler will recognize what type of operand is involved and invoke the proper operation, either integer, double real, or complex, etc.

MATRIX-BY-VECTOR PRODUCTS

11.5

Matrix-by-vector multiplications (sometimes called “Matvecs” for short) are relatively easy to implement efficiently on high performance computers. For a description of storage formats for sparse matrices, see Chapter 3. We will first discuss matrix-by-vector algorithms without consideration of sparsity. Then we will cover sparse Matvec operations for a few different storage formats.

11.5.1 THE CASE OF DENSE MATRICES

The computational kernels for performing sparse matrix operations such as matrix-by-vector products are intimately associated with the data structures used. However, there are a few general approaches that are common to different algorithms for matrix-by-vector products which can be described for dense matrices. Two popular ways of performing these operations are (1) the inner product form described in Algorithm 11.1, and (2) the SAXPY form described by Algorithm 11.2.

ALGORITHM 11.1: Dot Product Form – Dense Case

1. Do $i = 1, n$
 2. $y(i) = \text{dotproduct}(a(i,1:n), x(1:n))$
 3. EndDo
-

The dot product operation $\text{dotproduct}(v(1:n), w(1:n))$ computes the dot product of the two vectors v and w of length n each. If there is no ambiguity on the bounds, we simply write $\text{dotproduct}(v, w)$. The above algorithm proceeds by rows. It computes the dot-product of row i of the matrix A with the vector x and assigns the result to $y(i)$. The next algorithm

uses columns instead and results in the use of the SAXPY operations.

ALGORITHM 11.2: SAXPY Form – Dense Case

1. $y(1:n) = 0.0$
 2. Do $j = 1, n$
 3. $y(1:n) = y(1:n) + x(j) * a(1:n,j)$
 4. EndDo
-

The SAXPY form of the Matvec operation computes the result $y = Ax$ as a linear combination of the columns of the matrix A . A third possibility consists of performing the product by diagonals. This option bears no interest in the dense case, but it is at the basis of many important matrix-by-vector algorithms in the sparse case.

ALGORITHM 11.3: DIA Form – Dense Case

1. $y(1:n) = 0$
 2. Do $k = -n+1, n-1$
 3. Do $i = 1 - \min(k,0), n - \max(k,0)$
 4. $y(i) = y(i) + a(i,k+i)*x(k+i)$
 5. EndDo
 6. EndDo
-

The product is performed by diagonals, starting from the leftmost diagonal whose offset is $-n + 1$ to the rightmost diagonal whose offset is $n - 1$.

11.5.2 THE CSR AND CSC FORMATS

One of the most general schemes for storing sparse matrices is the Compressed Sparse Row storage format described in Chapter 3. Recall that the data structure consists of three arrays: a real array $A(1:nnz)$ to store the nonzero elements of the matrix row-wise, an integer array $JA(1:nnz)$ to store the column positions of the elements in the real array A , and, finally, a pointer array $IA(1:n+1)$, the i -th entry of which points to the beginning of the i -th row in the arrays A and JA . To perform the matrix-by-vector product $y = Ax$ in parallel using this format, note that each component of the resulting vector y can be computed independently as the dot product of the i -th row of the matrix with the vector x . This yields the following sparse version of Algorithm 11.1 for the case where the matrix is stored in CSR format.

ALGORITHM 11.4: CSR Format – Dot Product Form

1. Do $i = 1, n$
 2. $k1 = ia(i)$
 3. $k2 = ia(i+1)-1$
 4. $y(i) = \text{dotproduct}(a(k1:k2), x(ja(k1:k2)))$
 5. EndDo
-

Line 4 of the above algorithm computes the dot product of the vector with components $a(k1), a(k1+1), \dots, a(k2)$ with the vector with components $x(ja(k1)), x(ja(k1+1)), \dots, x(ja(k2))$.

The fact that the outer loop can be performed in parallel can be exploited on any parallel platform. On some shared-memory machines, the synchronization of this outer loop is inexpensive and the performance of the above program can be excellent. On distributed memory machines, the outer loop can be split in a number of steps to be executed on each processor. Thus, each processor will handle a few rows that are assigned to it. It is common to assign a certain number of rows (often contiguous) to each processor and to also assign the component of each of the vectors similarly. The part of the matrix that is needed is loaded in each processor initially. When performing a matrix-by-vector product, interprocessor communication will be necessary to get the needed components of the vector x that do not reside in a given processor. This important case will return in Section 11.5.6.

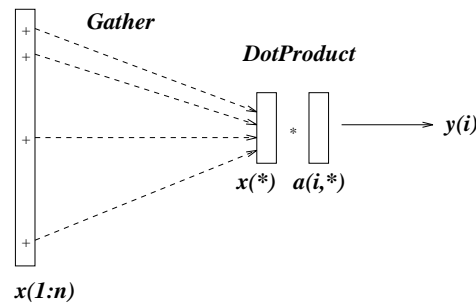

Figure 11.6 Illustration of the row-oriented matrix-by-vector multiplication.

The indirect addressing involved in the second vector in the dot product is called a *gather* operation. The vector $x(ja(k1:k2))$ is first “gathered” from memory into a vector of contiguous elements. The dot product is then carried out as a standard dot-product operation between two dense vectors. This is illustrated in Figure 11.6.

Example 11.1 This example illustrates the use of scientific libraries for performing sparse matrix operations. If the pseudo-code for Algorithm 11.4 is compiled as it is on the Connection Machine, in CM-FORTRAN (Thinking Machine’s early version of FORTRAN 90), the resulting computations will be executed on the front-end host of the CM-2 or the Control Processor (CP) of the CM-5, rather than on the PEs. This is due to the fact that the code does not involve any vector constructs. The scientific library (CMSSL) provides *gather* and *scatter* operations as well as *scan_add* operations which can be exploited to implement this algorithm more efficiently as is show in the following code segment:

```

y = 0.0
call sparse_util_gather ( tmp, x, gather_trace, . . . )
tmp = a*tmp
call cmf_scan_add ( tmp, tmp, cmf_upward, cmf_inclusive, . . . )

```

```
call sparse_util_scatter ( y, scatter_pointer, tmp,
    scatter_trace, ... )
```

The *sparse_util_gather* routine is first called to gather the corresponding entries from the vector x into a temporary array *tmp*, then the multiplications are carried out element-by-element in parallel. The *cmf_scan_add* routine from the CM Fortran Utility Library is used to perform the summation for each row. Finally, the call to *sparse_util_scatter* copies the results. Segmented scan-adds are particularly useful for implementing sparse matrix-by-vector products when they are provided as part of the libraries. Note that the *sparse_util_gather_setup* and *sparse_util_scatter_setup* routines must be called to compute the communication patterns, *gather_trace* and *scatter_trace*, before this algorithm is called. These tend to be expensive operations.

Now assume that the matrix is stored by columns (CSC format). The matrix-by-vector product can be performed by the following algorithm which is a sparse version of Algorithm 11.2.

ALGORITHM 11.5: CSC Format – SAXPY Form

1. $y(1:n) = 0.0$
 2. Do $i = 1, n$
 3. $k1 = ia(i)$
 4. $k2 = ia(i + 1) - 1$
 5. $y(ja(k1:k2)) = y(ja(k1:k2)) + x(i) * a(k1:k2)$
 6. EndDo
-

The above code initializes y to zero and then adds the vectors $x(j) \times a(1 : n, j)$ for $j = 1, \dots, n$ to it. It can also be used to compute the product of the *transpose* of a matrix by a vector, when the matrix is stored (row-wise) in the CSR format. Normally, the vector $y(ja(k1:k2))$ is gathered and the SAXPY operation is performed in vector mode. Then the resulting vector is “scattered” back into the positions $ja(*)$, by what is called a *Scatter* operation. This is illustrated in Figure 11.7.

A major difficulty with the above FORTRAN program is that it is intrinsically sequential. First, the outer loop is not parallelizable as it is, but this may be remedied as will be seen shortly. Second, the inner loop involves writing back results of the right-hand side into memory positions that are determined by the indirect address function *ja*. To be correct, $y(ja(1))$ must be copied first, followed by $y(ja(2))$, etc. However, if it is known that the mapping $ja(i)$ is one-to-one, then the order of the assignments no longer matters. Since compilers are not capable of deciding whether this is the case, a compiler directive from the user is necessary for the Scatter to be invoked.

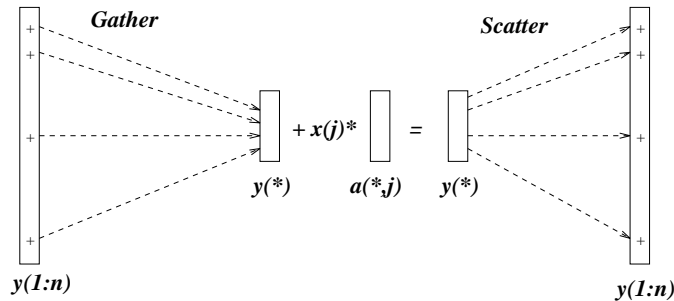

Figure 11.7 Illustration of the column-oriented matrix-by-vector multiplication.

Going back to the outer loop, p subsums can be computed (independently) into p separate temporary vectors and then these p subsums can be added at the completion of all these partial sums to obtain the final result. For example, an optimized version of the previous algorithm can be implemented as follows:

ALGORITHM 11.6: CSC Format – Split SAXPY Form

1. $tmp(1:n,1:p) = 0.0$
 2. Do $m=1, p$
 3. Do $j = m, n, p$
 4. $k1 = ia(j)$
 5. $k2 = ia(j + 1) - 1$
 6. $tmp(ja(k1:k2),j) = tmp(ja(k1:k2),j) + x(j) * a(k1:k2)$
 7. EndDo
 8. EndDo
 9. $y(1:n) = SUM(tmp, dim=2)$
-

The *SUM* across the second dimension at the end of the algorithm constitutes additional work, but it is highly vectorizable and parallelizable.

11.5.3 MATVECS IN THE DIAGONAL FORMAT

The above storage schemes are general but they do not exploit any special structure of the matrix. The *diagonal storage format* was one of the first data structures used in the context of high performance computing to take advantage of special sparse structures. Often, sparse matrices consist of a small number of diagonals in which case the matrix-by-vector product can be performed by diagonals as in Algorithm 11.3. For sparse matrices, most of the $2n - 1$ diagonals invoked in the outer loop of Algorithm 11.3 are zero. There are again different variants of Matvec algorithms for the diagonal format, related to different orderings of the loops in the basic FORTRAN program. Recall that the matrix is stored in a rectangular array $diag(1:n, 1:ndiag)$ and the offsets of these diagonals from the main diagonal may be stored in a small integer array $offset(1:ndiag)$. Consider a “dot-product” variant first.

ALGORITHM 11.7: DIA Format – Dot Product Form

```

1. Do i = 1, n
2.   tmp = 0.0d0
3.   Do j = 1, ndiag
4.     tmp = tmp + diag(i,j)*x(i+offset(j))
5.   EndDo
6.   y(i) = tmp
7. EndDo

```

In a second variant, the vector y is initialized to zero, and then x is multiplied by each of the diagonals and the separate results are added to y . The innermost loop in this computation is sometimes called a *Triad* operation.

ALGORITHM 11.8: Matvec in Triad Form

```

1. y = 0.0d0
2. Do j = 1, ndiag
3.   joff = offset(j)
4.   i1 = max(1, 1-offset(j))
5.   i2 = min(n, n-offset(j))
6.   y(i1:i2) = y(i1:i2) + diag(i1:i2,j)*x(i1+joff:i2+joff)
7. EndDo

```

Good speeds can be reached on vector machines when the matrix is large enough.

One drawback with diagonal storage is that it is not general enough. For general sparse matrices, we can either generalize the diagonal storage scheme or reorder the matrix in order to obtain a diagonal structure. The simplest generalization is the Ellpack-Itpack Format.

11.5.4 THE ELLPACK-ITPACK FORMAT

The Ellpack-Itpack (or Ellpack) format is of interest only for matrices whose maximum number of nonzeros per row, $jmax$, is small. The nonzero entries are stored in a real array $ae(1:n, 1:jmax)$. Along with this is integer array $jae(1:n, 1:jmax)$ which stores the column indices of each corresponding entry in ae . Similar to the diagonal scheme, there are also two basic ways of implementing a matrix-by-vector product when using the Ellpack format. We begin with an analogue of Algorithm 11.7.

ALGORITHM 11.9: Ellpack Format – Dot-Product Form

```

1. Do i = 1, n
2.   yi = 0
3.   Do j = 1, ncol
4.     yi = yi + ae(j,i) * x(jae(j,i))
5.   EndDo

```

6. $y(i) = yi$
7. *EndDo*

In data-parallel mode, the above algorithm can be implemented by using a temporary two-dimensional array to store the values $x(ja(j, i))$, and then performing a pointwise array product of a and this two-dimensional array. The result is then summed along the rows

```
forall ( i=1:n, j=1:ncol ) tmp(i,j) = x(jae(i,j))
y = SUM(ae*tmp, dim=2).
```

The FORTRAN *forall* construct performs the operations as controlled by the loop heading, in parallel. Alternatively, use of the temporary array can be avoided by recoding the above lines as follows:

```
forall ( i = 1:n ) y(i) = SUM(ae(i,1:ncol)*x(jae(i,1:ncol))) .
```

The main difference between these loops and the previous ones for the diagonal format is the presence of indirect addressing in the innermost computation. A disadvantage of the Ellpack format is that if the number of nonzero elements per row varies substantially, many zero elements must be stored unnecessarily. Then the scheme becomes inefficient. As an extreme example, if all rows are very sparse except for one of them which is full, then the arrays ae , jae must be full $n \times n$ arrays, containing mostly zeros. This is remedied by a variant of the format which is called the *jagged diagonal format*.

11.5.5 THE JAGGED DIAGONAL FORMAT

A more general alternative to the diagonal or Ellpack format is the Jagged Diagonal (JAD) format. This can be viewed as a generalization of the Ellpack-Itpack format which removes the assumption on the fixed length rows. To build the jagged diagonal structure, start from the CSR data structure and sort the rows of the matrix by decreasing number of nonzero elements. To build the first “jagged diagonal” (j-diagonal), extract the first element from each row of the CSR data structure. The second jagged diagonal consists of the second elements of each row in the CSR data structure. The third, fourth, . . . , jagged diagonals can then be extracted in the same fashion. The lengths of the successive j-diagonals decreases. The number of j-diagonals that can be extracted is equal to the number of nonzero elements of the first row of the permuted matrix, i.e., to the largest number of nonzero elements per row. To store this data structure, three arrays are needed: a real array DJ to store the values of the jagged diagonals, the associated array $JDIAG$ which stores the column positions of these values, and a pointer array $IDIAG$ which points to the beginning of each j-diagonal in the DJ , $JDIAG$ arrays.

Example 11.2 Consider the following matrix and its sorted version PA :

$$A = \begin{pmatrix} 1. & 0. & 2. & 0. & 0. \\ 3. & 4. & 0. & 5. & 0. \\ 0. & 6. & 7. & 0. & 8. \\ 0. & 0. & 9. & 10. & 0. \\ 0. & 0. & 0. & 11. & 12. \end{pmatrix} \rightarrow PA = \begin{pmatrix} 3. & 4. & 0. & 5. & 0. \\ 0. & 6. & 7. & 0. & 8. \\ 1. & 0. & 2. & 0. & 0. \\ 0. & 0. & 9. & 10. & 0. \\ 0. & 0. & 0. & 11. & 12. \end{pmatrix}$$

The rows of PA have been obtained from those of A by sorting them by number of nonzero elements, from the largest to the smallest number. Then the JAD data structure for A is as follows:

DJ	3.	6.	1.	9.	11.	4.	7.	2.	10.	12.	5.	8.
JDIAG	1	2	1	3	4	2	3	3	4	5	4	5
IDIAG	1	6	11	13								

Thus, there are two j-diagonals of full length (five) and one of length two.

A matrix-by-vector product with this storage scheme can be performed by the following code segment.

1. Do $j=1, ndiag$
2. $k1 = idiag(j)$
3. $k2 = idiag(j+1) - 1$
4. $len = idiag(j+1) - k1$
5. $y(1:len) = y(1:len) + dj(k1:k2)*x(jdiag(k1:k2))$
6. EndDo

Since the rows of the matrix A have been permuted, the above code will compute PAx , a permutation of the vector Ax , rather than the desired Ax . It is possible to permute the result back to the original ordering after the execution of the above program. This operation can also be performed until the final solution has been computed, so that only two permutations on the solution vector are needed, one at the beginning and one at the end. For preconditioning operations, it may be necessary to perform a permutation before or within each call to the preconditioning subroutines. There are many possible variants of the jagged diagonal format. One variant which does not require permuting the rows is described in Exercise 8.

11.5.6 THE CASE OF DISTRIBUTED SPARSE MATRICES

Given a sparse linear system to be solved on a distributed memory environment, it is natural to map pairs of equations-unknowns to the same processor in a certain predetermined way. This mapping can be determined automatically by a graph partitioner or it can be assigned ad hoc from knowledge of the problem. Assume that there is a convenient partitioning of the adjacency graph. Without any loss of generality, the matrix under consideration can be viewed as originating from the discretization of a Partial Differential Equation on a certain domain. This is illustrated in Figure 11.8. Initially, assume that each subgraph (or subdomain, in the PDE literature) is assigned to a different processor, although this restriction

can be relaxed, i.e., a processor can hold several subgraphs to increase parallelism.

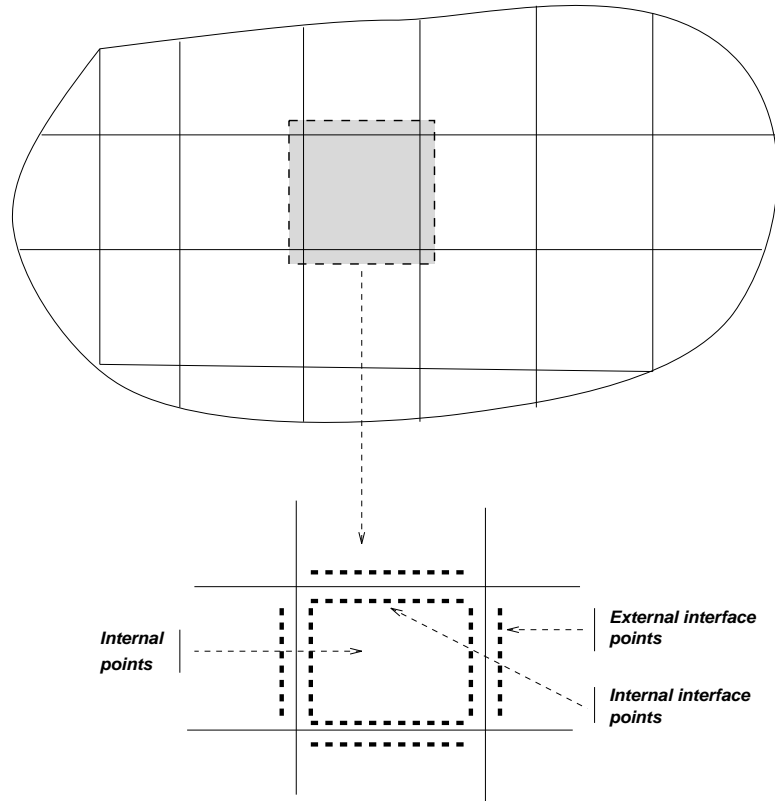

Figure 11.8 Decomposition of physical domain or adjacency graph and the local data structure.

A local data structure must be set up in each processor (or subdomain, or subgraph) which will allow the basic operations such as (global) matrix-by-vector products and preconditioning operations to be performed efficiently. The only assumption to make regarding the mapping is that if row number i is mapped into processor p , then so is the unknown i , i.e., the matrix is distributed row-wise across the processors according to the distribution of the variables. The graph is assumed to be undirected, i.e., the matrix has a symmetric pattern.

It is important to “preprocess the data” in order to facilitate the implementation of the communication tasks and to gain efficiency during the iterative process. The preprocessing requires setting up the following: information *in each processor*.

1. List of processors with which communication will take place. These are called “neighboring processors” although they may not be physically nearest neighbors.
2. List of local nodes that are coupled with external nodes. These are the *local interface nodes*.
3. Local representation of the distributed matrix in each processor.

In order to perform a matrix-by-vector product with a distributed sparse matrix, the matrix consisting of rows that are local to a given processor must be multiplied by some global vector v . Some components of this vector will be local, and some components must be brought from external processors. These external variables correspond to interface points belonging to adjacent subdomains. When performing a matrix-by-vector product, neighboring processors must exchange values of their adjacent interface nodes.

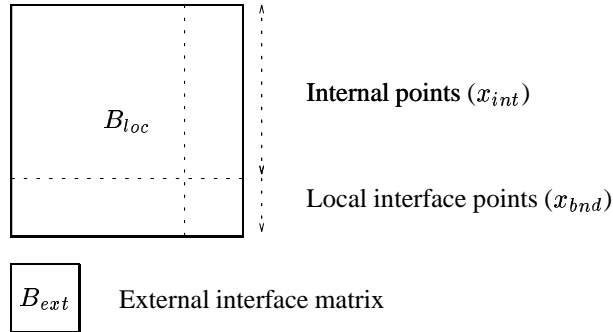

Figure 11.9 The local matrices and data structure associated with each subdomain.

Let A_{loc} be the local part of the matrix, i.e., the (rectangular) matrix consisting of all the rows that are mapped to *myproc*. Call B_{loc} the “diagonal block” of A_{loc} , i.e., the submatrix of A_{loc} whose nonzero elements a_{ij} are such that j is a local variable. Similarly, call B_{ext} the “offdiagonal” block, i.e., the submatrix of A_{loc} whose nonzero elements a_{ij} are such that j is *not* a local variable. To perform a matrix-by-vector product, start multiplying the diagonal block B_{loc} by the local variables. Then, multiply the external variables by the sparse matrix B_{ext} . Notice that since the external interface points are not coupled with local internal points, only the rows $n_{int} + 1$ to n_{nloc} in the matrix B_{ext} will have nonzero elements. Thus, the matrix-by-vector product can be separated into two such operations, one involving only the local variables and the other involving external variables. It is necessary to construct these two matrices and define a local numbering of the local variables in order to perform the two matrix-by-vector products efficiently each time.

To perform a global matrix-by-vector product, with the distributed data structure described above, each processor must perform the following operations. First, multiply the local variables by the matrix B_{loc} . Second, obtain the external variables from the neighboring processors in a certain order. Third, multiply these by the matrix B_{ext} and add the resulting vector to the one obtained from the first multiplication by B_{loc} . Note that the first and second steps can be done in parallel. With this decomposition, the global matrix-by-vector product can be implemented as indicated in Algorithm 11.10 below. In what follows, x_{loc} is a vector of variables that are local to a given processor. The components corresponding to the local interface points (ordered to be the last components in x_{loc} for convenience) are called x_{bnd} . The external interface points, listed in a certain order, constitute a vector which is called x_{ext} . The matrix B_{loc} is a sparse $n_{loc} \times n_{loc}$ matrix which represents the restriction of A to the local variables x_{loc} . The matrix B_{ext} operates on the

external variables x_{ext} to give the correction which must be added to the vector $B_{loc}x_{loc}$ in order to obtain the desired result $(Ax)_{loc}$.

ALGORITHM 11.10: Distributed Sparse Matrix Product Kernel

1. Exchange interface data, i.e.,
 2. Scatter x_{bnd} to neighbors and
 3. Gather x_{ext} from neighbors
 4. Do Local Matvec: $y = B_{loc}x_{loc}$
 5. Do External Matvec: $y = y + B_{ext}x_{ext}$
-

An important observation is that the matrix-by-vector products in lines 4 and 5 can use any convenient data structure that will improve efficiency by exploiting knowledge on the local architecture. An example of the implementation of this operation is illustrated next:

```
call bdxchg(nloc,x,y,nproc,proc,ix,ipr,type,xlen,iout)
y(1:nloc) = 0.0
call amux1(nloc,x,y,aloc,jaloc,ialoc)
nrow = nloc - nbnd + 1
call amux1(nrow,x,y(nbnd),aloc,jaloc,ialoc(nloc+1))
```

In the above code segment, *bdxchg* is the only routine requiring communication. Its purpose is to exchange interface values between nearest neighbor processors. The first call to *amux1* performs the operation $y := y + B_{loc}x_{loc}$, where y has been initialized to zero prior to the call. The second call to *amux1* performs $y := y + B_{ext}x_{ext}$. Notice that the data for the matrix B_{ext} is simply appended to that of B_{loc} , a standard technique used for storing a succession of sparse matrices. The B_{ext} matrix acts only on the subvector of x which starts at location $nbnd$ of x . The size of the B_{ext} matrix is $nrow = nloc - nbnd + 1$.

STANDARD PRECONDITIONING OPERATIONS

11.6

Each step of a preconditioned iterative method requires the solution of a linear system of equations

$$Mz = y.$$

This section only considers those traditional preconditioners, such as ILU or SOR or SSOR, in which the solution with M is the result of solving triangular systems. Since these are commonly used, it is important to explore ways to implement them efficiently in a parallel environment. We only consider lower triangular systems of the form

$$Lx = b. \tag{11.1}$$

Without loss of generality, it is assumed that L is unit lower triangular.

11.6.1 PARALLELISM IN FORWARD SWEEPS

Typically in solving a lower triangular system, the solution is overwritten onto the right-hand side on return. In other words, there is one array x for both the solution and the right-hand side. Therefore, the forward sweep for solving a lower triangular system with coefficients $al(i, j)$ and right-hand-side x is as follows.

ALGORITHM 11.11: Sparse Forward Elimination

1. Do $i=2, n$
 2. For (all j such that $al(i,j)$ is nonzero) Do:
 3. $x(i) := x(i) - al(i,j) * x(j)$
 4. EndDo
 5. EndDo
-

Assume that the matrix is stored row wise in the general Compressed Sparse Row (CSR) format, except that the diagonal elements (ones) are not stored. Then the above algorithm translates into the following code segment:

1. Do $i=2, n$
2. Do $j=ial(i), ial(i+1) - 1$
3. $x(i)=x(i) - al(j) * x(jal(j))$
4. EndDo
5. EndDo

The outer loop corresponding to the variable i is sequential. The j loop is a sparse dot product of the i^{th} row of L and the (dense) vector x . This dot product may be split among the processors and the partial results may be added at the end. However, the length of the vector involved in the dot product is typically short. So, this approach is quite inefficient in general. We examine next a few alternative approaches. The regularly structured and the irregularly structured cases are treated separately.

11.6.2 LEVEL SCHEDULING: THE CASE OF 5-POINT MATRICES

First, consider an example which consists of a 5-point matrix associated with a 4×3 mesh as represented in Figure 11.10. The lower triangular matrix associated with this mesh is represented in the left side of Figure 11.10. The stencil represented in the right side of Figure 11.10 establishes the data dependence between the unknowns in the lower triangular system solution when considered from the point of view of a grid of unknowns. It tells us that in order to compute the unknown in position (i, j) , only the two unknowns in positions $(i - 1, j)$ and $(i, j - 1)$ are needed. The unknown x_{11} does not depend on any other variable and can be computed first. Then the value of x_{11} can be used to get $x_{1,2}$ and $x_{2,1}$ simultaneously. Then these two values will in turn enable $x_{3,1}$, $x_{2,2}$ and $x_{1,3}$ to be obtained simultaneously, and so on. Thus, the computation can proceed in wavefronts. The steps for this wavefront algorithm are shown with dashed lines in Figure 11.10. Observe that the

maximum degree of parallelism (or vector length, in the case of vector processing) that can be reached is the minimum of n_x, n_y , the number of mesh points in the x and y directions, respectively, for 2-D problems. For 3-D problems, the parallelism is of the order of the maximum size of the sets of domain points $x_{i,j,k}$, where $i + j + k = lev$, a constant level lev . It is important to note that there is little parallelism or vectorization at the beginning and at the end of the sweep. The degree of parallelism is equal to one initially, and then increases by one for each wave reaching its maximum, and then decreasing back down to one at the end of the sweep. For example, for a 4×3 grid, the levels (sets of equations that can be solved in parallel) are $\{1\}$, $\{2, 5\}$, $\{3, 6, 9\}$, $\{4, 7, 10\}$, $\{8, 11\}$, and finally $\{12\}$. The first and last few steps may take a heavy toll on achievable speed-ups.

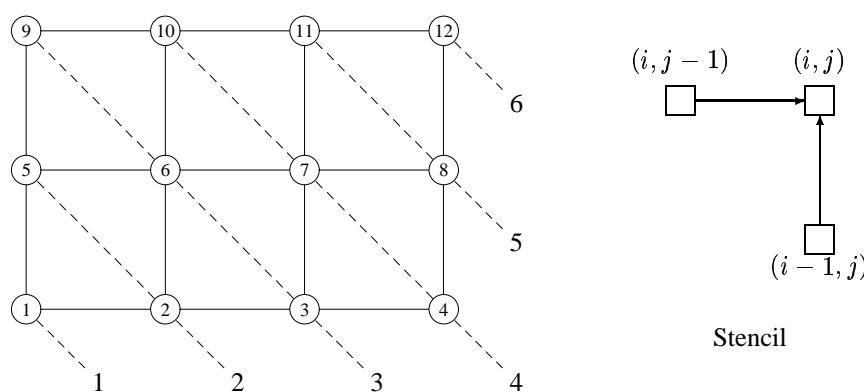

Figure 11.10 Level scheduling for a 4×3 grid problem.

The idea of proceeding by *levels* or *wavefronts* is a natural one for finite difference matrices on rectangles. Discussed next is the more general case of irregular matrices, a textbook example of scheduling, or *topological sorting*, and is well known in different forms to computer scientists.

11.6.3 LEVEL SCHEDULING FOR IRREGULAR GRAPHS

The simple scheme described above can be generalized for irregular grids. The objective of the technique, called *level scheduling*, is to group the unknowns in subsets so that they can be determined simultaneously. To explain the idea, consider again Algorithm 11.11 for solving a unit lower triangular system. The i -th unknown can be determined once all the other ones that participate in equation i become available. In the i -th step, all unknowns j that $al(i, j) \neq 0$ must be known. To use graph terminology, these unknowns are *adjacent* to unknown number i . Since L is lower triangular, the adjacency graph is a directed acyclic graph. The edge $j \rightarrow i$ in the graph simply indicates that x_j must be known before x_i can be determined. It is possible and quite easy to find a labeling of the nodes that satisfy the property that if $label(j) < label(i)$, then task j must be executed before task i . This is called a *topological sorting* of the unknowns.

The first step computes x_1 and any other unknowns for which there are no predecessors

in the graph, i.e., all those unknowns x_i for which the offdiagonal elements of row i are zero. These unknowns will constitute the elements of the first level. The next step computes in parallel all those unknowns that will have the nodes of the first level as their (only) predecessors in the graph. The following steps can be defined similarly: The unknowns that can be determined at step l are all those that have as predecessors equations that have been determined in steps $1, 2, \dots, l - 1$. This leads naturally to the definition of a *depth* for each unknown. The *depth* of a vertex is defined by performing the following loop for $i = 1, 2, \dots, n$, after initializing $depth(j)$ to zero for all j .

$$depth(i) = 1 + \max_j \{depth(j), \text{ for all } j \text{ such that } al(i, j) \neq 0\}.$$

By definition, a *level* of the graph is the set of nodes with the same depth. A data structure for the levels can be defined: A permutation $q(1 : n)$ defines the new ordering and $level(i), i = 1, \dots, nlev + 1$ points to the beginning of the i -th level in that array.

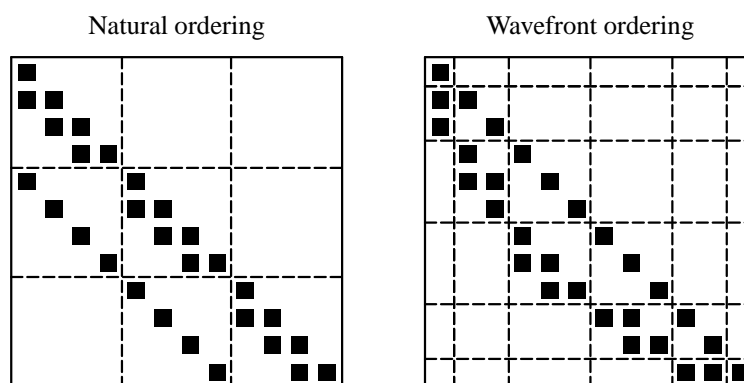

Figure 11.11 Lower triangular matrix associated with mesh of Figure 11.10.

Once these level sets are found, there are two different ways to proceed. The permutation vector q can be used to permute the matrix according to the new order. In the 4×3 example mentioned in the previous subsection, this means renumbering the variables $\{1\}, \{2, 5\}, \{3, 6, 9\}, \dots$, consecutively, i.e., as $\{1, 2, 3, \dots\}$. The resulting matrix after the permutation is shown in the right side of Figure 11.11. An alternative is simply to keep the permutation array and use it to identify unknowns that correspond to a given level in the solution. Then the algorithm for solving the triangular systems can be written as follows, assuming that the matrix is stored in the usual row sparse matrix format.

ALGORITHM 11.12: Forward Elimination with Level Scheduling

1. Do $lev=1, nlev$
2. $j1 = level(lev)$
3. $j2 = level(lev+1) - 1$
4. Do $k = j1, j2$
5. $i = q(k)$
6. Do $j = ial(i), ial(i+1) - 1$

```

7.      x(i) = x(i) - al(j) * x(jal(j))
8.      EndDo
9.      EndDo
10. EndDo

```

An important observation here is that the outer loop, which corresponds to a level, performs an operation of the form

$$x := x - Bx$$

where B is a submatrix consisting only of the rows of level lev , and excluding the diagonal elements. This operation can in turn be optimized by using a proper data structure for these submatrices. For example, the JAD data structure can be used. The resulting performance can be quite good. On the other hand, implementation can be quite involved since two embedded data structures are required.

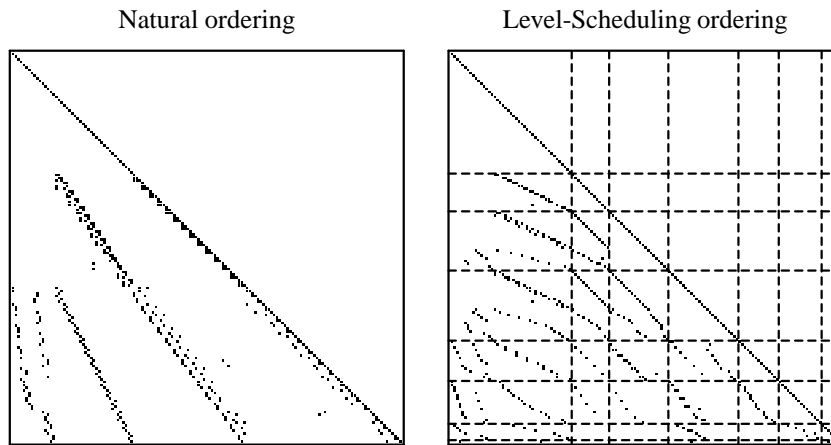

Figure 11.12 Lower-triangular matrix associated with a finite element matrix and its level-ordered version.

Example 11.3 Consider a finite element matrix obtained from the example shown in Figure 3.1. After an additional level of refinement, done in the same way as was described in Chapter 3, the resulting matrix, shown in the left part of Figure 11.12, is of size $n = 145$. In this case, 8 levels are obtained. If the matrix is reordered by levels, the matrix shown in the right side of the figure results. The last level consists of only one element.

EXERCISES

1. Give a short answer to each of the following questions:
 - a. What is the main disadvantage of shared memory computers based on a bus architecture?
 - b. What is the main factor in yielding the speed-up in pipelined processors?
 - c. Related to the previous question: What is the main limitation of pipelined processors in regards to their potential for providing high speed-ups?
2. Show that the number of edges in a binary n -cube is $n2^{n-1}$.
3. Show that a binary 4-cube is identical with a *torus* which is a 4×4 mesh with wrap-around connections. Are there hypercubes of any other dimensions that are equivalent topologically to toruses?
4. A Gray code of length $k = 2^n$ is a sequence a_0, \dots, a_{k-1} of n -bit binary numbers such that (a) any two successive numbers in the sequence differ by one and only one bit; (b) all n -bit binary numbers are represented in the sequence; and (c) a_0 and a_{k-1} differ by one bit.
 - a. Find a Gray code sequence of length $k = 8$ and show the (closed) path defined by the sequence of nodes of a 3-cube, whose labels are the elements of the Gray code sequence. What type of paths does a Gray code define in a hypercube?
 - b. To build a “binary reflected” Gray code, start with the trivial Gray code sequence consisting of the two one-bit numbers 0 and 1. To build a two-bit Gray code, take the same sequence and insert a zero in front of each number, then take the sequence in *reverse order* and insert a one in front of each number. This gives $G_2 = \{00, 01, 11, 10\}$. The process is repeated until an n -bit sequence is generated. Show the binary reflected Gray code sequences of length 2, 4, 8, and 16. Prove (by induction) that this process does indeed produce a valid Gray code sequence.
 - c. Let an n -bit Gray code be given and consider the sub-sequence of all elements whose first bit is constant (e.g., zero). Is this an $n - 1$ bit Gray code sequence? Generalize this to any of the n -bit positions. Generalize further to any set of $k < n$ bit positions.
 - d. Use the previous question to find a strategy to map a $2^{n_1} \times 2^{n_2}$ mesh into an $(n_1 + n_2)$ -cube.
5. Consider a ring of k processors which are characterized by the following communication performance characteristics. Each processor can communicate with its two neighbors *simultaneously*, i.e., it can send or receive a message while sending or receiving another message. The time for a message of length m to be transmitted between two nearest neighbors is of the form

$$\beta + m\tau.$$

- a. A message of length m is “broadcast” to all processors by sending it from P_1 to P_2 and then from P_2 to P_3 , etc., until it reaches all destinations, i.e., until it reaches P_k . How much time does it take for the message to complete this process?
- b. Now split the message into packets of equal size and pipeline the data transfer. Typically, each processor will receive packet number i from the previous processor, while sending packet $i - 1$ it has already received to the next processor. The packets will travel in chain from P_1 to P_2, \dots, P_k . In other words, each processor executes a program that is described roughly as follows:

```
Do i=1, Num_packets
```

```

    Receive Packet number i from Previous Processor
    Send Packet number i to Next Processor
EndDo

```

There are a few additional conditionals. Assume that the number of packets is equal to $k - 1$. How much time does it take for all packets to reach all k processors? How does this compare with the simple method in (a)?

6. (a) Write a short FORTRAN routine (or C function) which sets up the level number of each unknown of an upper triangular matrix. The input matrix is in CSR format and the output should be an array of length n containing the level number of each node. (b) What data structure should be used to represent levels? Without writing the code, show how to determine this data structure from the output of your routine. (c) Assuming the data structure of the levels has been determined, write a short FORTRAN routine (or C function) to solve an upper triangular system using the data structure resulting in the previous question. Show clearly which loop should be executed in parallel.
7. In the jagged diagonal format described in Section 11.5.5, it is necessary to preprocess the matrix by sorting its rows by decreasing number of rows. What type of sorting should be used for this purpose?
8. In the jagged diagonal format described in Section 11.5.5, the matrix had to be preprocessed by sorting it by rows of decreasing number of elements.
 - a. What is the main reason it is necessary to reorder the rows?
 - b. Assume that the same process of extracting one element per row is used. At some point the extraction process will come to a stop and the remainder of the matrix can be put into a CSR data structure. Write down a good data structure to store the two pieces of data and a corresponding algorithm for matrix-by-vector products.
 - c. This scheme is efficient in many situations but can lead to problems if the first row is very short. Suggest how to remedy the situation by padding with zero elements, as is done for the Ellpack format.
9. Many matrices that arise in PDE applications have a structure that consists of a few diagonals and a small number of nonzero elements scattered irregularly in the matrix. In such cases, it is advantageous to extract the diagonal part and put the rest in a general sparse (e.g., CSR) format. Write a pseudo-code to extract the main diagonals and the sparse part. As input parameter, the number of diagonals desired must be specified.

NOTES AND REFERENCES. Kai Hwang's book [124] is recommended for an overview of parallel architectures. More general recommended reading on parallel computing are the book by Bertsekas and Tsitsiklis [25] and a more recent volume by Kumar et al. [139]. One characteristic of high-performance architectures is that trends come and go rapidly. A few years ago, it seemed that massive parallelism was synonymous with distributed memory computing, specifically of the hypercube type. Currently, many computer vendors are mixing message-passing paradigms with "global address space," i.e., shared memory viewpoint. This is illustrated in the recent T3D machine built by CRAY Research. This machine is configured as a three-dimensional torus and allows all three programming paradigms discussed in this chapter, namely, data-parallel, shared memory, and message-passing. It is likely that the T3D will set a certain trend. However, another recent development is the advent of network supercomputing which is motivated by astounding gains both in workstation performance and in high-speed networks. It is possible to solve large problems on clusters of workstations and to

obtain excellent performance at a fraction of the cost of a massively parallel computer.

Regarding parallel algorithms, the survey paper of Ortega and Voigt [156] gives an exhaustive bibliography for research done before 1985 in the general area of solution of Partial Differential Equations on supercomputers. An updated bibliography by Ortega, Voigt, and Romine is available in [99]. See also the survey [178] and the monograph [71]. Until the advent of supercomputing in the mid 1970s, storage schemes for sparse matrices were chosen mostly for convenience as performance was not an issue, in general. The first paper showing the advantage of diagonal storage schemes in sparse matrix computations is probably [133]. The first discovery by supercomputer manufacturers of the specificity of sparse matrix computations was the painful realization that without hardware support, vector computers could be inefficient. Indeed, the early CRAY machines did not have hardware instructions for gather and scatter operations but this was soon remedied in the second-generation machines. For a detailed account of the beneficial impact of hardware for “scatter” and “gather” on vector machines, see [146].

Level scheduling is a textbook example of topological sorting in graph theory and was discussed from this viewpoint in, e.g., [8, 190, 228]. For the special case of finite difference matrices on rectangular domains, the idea was suggested by several authors independently, [208, 209, 111, 186, 10]. In fact, the level scheduling approach described in this chapter is a “greedy” approach and is unlikely to be optimal. There is no reason why an equation should be solved as soon as it is possible. For example, it may be preferable to use a *backward scheduling* [7] which consists of defining the levels from bottom up in the graph. Thus, the last level consists of the leaves of the graph, the previous level consists of their predecessors, etc. Dynamic scheduling can also be used as opposed to static scheduling. The main difference is that the level structure is not preset; rather, the order of the computation is determined at run-time. The advantage over pre-scheduled triangular solutions is that it allows processors to always execute a task as soon as its predecessors have been completed, which reduces idle time. On loosely coupled distributed memory machines, this approach may be the most viable since it will adjust dynamically to irregularities in the execution and communication times that can cause a lock-step technique to become inefficient. However, for those shared memory machines in which hardware synchronization is available and inexpensive, dynamic scheduling would have some disadvantages since it requires managing queues and generates explicitly busy waits. Both approaches have been tested and compared in [22, 189] where it was concluded that on the Encore Multimax dynamic scheduling is usually preferable except for problems with few synchronization points and a large degree of parallelism. In [118], a combination of prescheduling and dynamic scheduling was found to be the best approach on a Sequent balance 21000. There seems to have been no comparison of these two approaches on distributed memory machines or on shared memory machines with microtasking or hardware synchronization features. In [22, 24] and [7, 8], a number of experiments are presented to study the performance of level scheduling within the context of preconditioned Conjugate Gradient methods. Experiments on an Alliant FX-8 indicated that a speed-up of around 4 to 5 can be achieved easily. These techniques have also been tested for problems in Computational Fluid Dynamics [214, 216]. ■

PARALLEL PRECONDITIONERS

This chapter covers a few alternative methods for preconditioning a linear system. These methods are suitable when the desired goal is to maximize parallelism. The simplest approach is the diagonal (or Jacobi) preconditioning. Often, this preconditioner is not very useful, since the number of iterations of the resulting iteration tends to be much larger than the more standard variants, such as ILU or SSOR. When developing parallel preconditioners, one should beware that the benefits of increased parallelism are not outweighed by the increased amount of computations. The main question to ask is whether or not it is possible to find preconditioning techniques that have a high degree of parallelism, as well as good intrinsic qualities.

INTRODUCTION

12.1

As seen in the previous chapter, a limited amount of parallelism can be extracted from the standard preconditioners such as ILU and SSOR. Fortunately, a number of alternative techniques can be developed that are specifically targeted at parallel environments. These are preconditioning techniques that would normally not be used on a standard machine, but only for parallel computers. There are at least three such types of techniques discussed in this chapter. The simplest approach is to use a Jacobi or, even better, a block Jacobi approach. In the simplest case, a Jacobi preconditioner may consist of the diagonal or a block-diagonal of A . To enhance performance, these preconditioners can themselves be accelerated by polynomial iterations, i.e., a second level of preconditioning called *polynomial preconditioning*.

A different strategy altogether is to enhance parallelism by using graph theory algorithms, such as graph-coloring techniques. These consist of coloring nodes such that two adjacent nodes have different colors. The gist of this approach is that all unknowns associated with the same color can be determined simultaneously in the forward and backward sweeps of the ILU preconditioning operation.

Finally, a third strategy uses generalizations of “partitioning” techniques, which can

be put in the general framework of “domain decomposition” approaches. These will be covered in detail in the next chapter.

Algorithms are emphasized rather than implementations. There are essentially two types of algorithms, namely, those which can be termed *coarse-grain* and those which can be termed *fine-grain*. In coarse-grain algorithms, the parallel tasks are relatively big and may, for example, involve the solution of small linear systems. In fine-grain parallelism, the subtasks can be elementary floating-point operations or consist of a few such operations. As always, the dividing line between the two classes of algorithms is somewhat blurred.

BLOCK-JACOBI PRECONDITIONERS

12.2

Overlapping block-Jacobi preconditioning consists of a general block-Jacobi approach as described in Chapter 4, in which the sets \mathcal{S}_i overlap. Thus, we define the index sets

$$\mathcal{S}_i = \{j \mid l_i \leq j \leq r_i\}$$

with

$$\begin{aligned} l_1 &= 1 \\ r_p &= n \\ r_i &> l_{i+1}, \quad 1 \leq i \leq p-1 \end{aligned}$$

where p is the number of blocks. Now use the block-Jacobi method with this particular partitioning, or employ the general framework of additive projection processes of Chapter 5, and use an additive projection method onto the sequence of subspaces

$$K_i = \text{span}\{V_i\}, \quad V_i = [e_{l_i}, e_{l_i+1}, \dots, e_{r_i}].$$

Each of the blocks will give rise to a correction of the form

$$\xi_i^{(k+1)} = \xi_i^{(k)} + A_i^{-1} V_i^T (b - Ax^{(k)}). \quad (12.1)$$

One problem with the above formula is related to the overlapping portions of the x variables. The overlapping sections will receive two different corrections in general. According to the definition of “additive projection processes” seen in Chapter 5, the next iterate can be defined as

$$x_{k+1} = x_k + \sum_{i=1}^p V_i A_i^{-1} V_i^T r_k$$

where $r_k = b - Ax_k$ is the residual vector at the previous iteration. Thus, the corrections for the overlapping regions simply are added together. It is also possible to weigh these contributions before adding them up. This is equivalent to redefining (12.1) into

$$\xi_i^{(k+1)} = \xi_i^{(k)} + D_i A_i^{-1} V_i^T (b - Ax_k)$$

in which D_i is a nonnegative diagonal matrix of weights. It is typical to weigh a nonoverlapping contribution by one and an overlapping contribution by $1/k$ where k is the number

of times the unknown is represented in the partitioning.

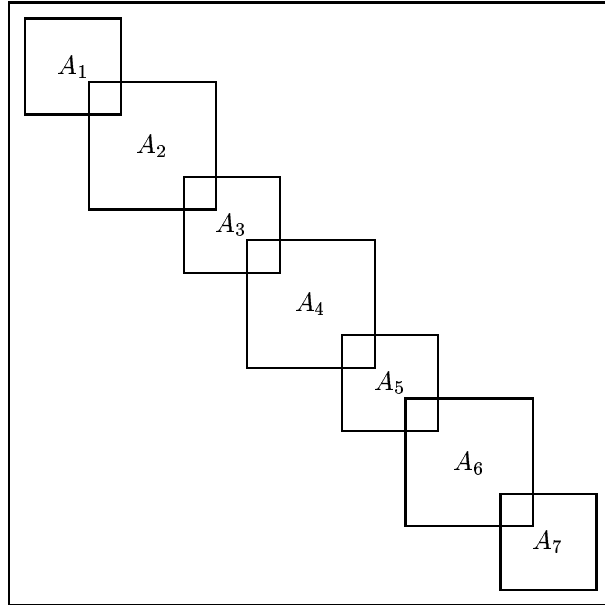

Figure 12.1 *The block-Jacobi matrix with overlapping blocks.*

The block-Jacobi iteration is often over- or under-relaxed, using a relaxation parameter ω . The iteration can be defined in the form

$$x_{k+1} = x_k + \sum_{i=1}^p \omega_i V_i A_i^{-1} V_i^T r_k.$$

Recall that the residual at step $k + 1$ is then related to that at step k by

$$r_{k+1} = \left[I - \sum_{i=1}^p \omega_i A V_i (V_i^T A V_i)^{-1} V_i^T \right] r_k.$$

The solution of a sparse linear system is required at each projection step. These systems can be solved by direct methods if the subblocks are small enough. Otherwise, iterative methods may be used. The outer loop accelerator should then be a flexible variant, such as FGMRES, which can accommodate variations in the preconditioners.

POLYNOMIAL PRECONDITIONERS

12.3

In polynomial preconditioning the matrix M is defined by

$$M^{-1} = s(A)$$

where s is a polynomial, typically of low degree. Thus, the original system is replaced by the preconditioned system

$$s(A)Ax = s(A)b \quad (12.2)$$

which is then solved by a conjugate gradient-type technique. Note that $s(A)$ and A commute and, as a result, the preconditioned matrix is the same for right or left preconditioning. In addition, the matrix $s(A)$ or $As(A)$ does not need to be formed explicitly since $As(A)v$ can be computed for any vector v from a sequence of matrix-by-vector products.

Initially, this approach was motivated by the good performance of matrix-vector operations on vector computers for long vectors, e.g., the Cyber 205. However, the idea itself is an old one and has been suggested by Stiefel [204] for eigenvalue calculations in the mid 1950s. Next, some of the popular choices for the polynomial s are described.

12.3.1 NEUMANN POLYNOMIALS

The simplest polynomial s which has been used is the polynomial of the Neumann series expansion

$$I + N + N^2 + \cdots + N^s$$

in which

$$N = I - \omega A$$

and ω is a scaling parameter. The above series comes from expanding the inverse of ωA using the splitting

$$\omega A = I - (I - \omega A).$$

This approach can also be generalized by using a splitting of the form

$$\omega A = D - (D - \omega A)$$

where D can be the diagonal of A or, more appropriately, a block diagonal of A . Then,

$$\begin{aligned} (\omega A)^{-1} &= [D(I - (I - \omega D^{-1}A))]^{-1} \\ &= [I - (I - \omega D^{-1}A)]^{-1} D^{-1}. \end{aligned}$$

Thus, setting

$$N = I - \omega D^{-1}A$$

results in the approximate s -term expansion

$$(\omega A)^{-1} \approx M^{-1} \equiv [I + N + \cdots + N^s] D^{-1}. \quad (12.3)$$

Since $D^{-1}A = \omega^{-1}[I - N]$, note that

$$\begin{aligned} M^{-1}A &= [I + N + \cdots + N^s] D^{-1}A \\ &= \frac{1}{\omega} [I + N + \cdots + N^s] (I - N) \\ &= \frac{1}{\omega} (I - N^{s+1}). \end{aligned}$$

The matrix operation with the preconditioned matrix can be difficult numerically for large s . If the original matrix is Symmetric Positive Definite, then $M^{-1}A$ is not symmetric, but it is self-adjoint with respect to the D -inner product; see Exercise 1.

12.3.2 CHEBYSHEV POLYNOMIALS

The polynomial s can be selected to be optimal in some sense, and this leads to the use of Chebyshev polynomials. The criterion that is used makes the preconditioned matrix $s(A)A$ as close as possible to the identity matrix in some sense. For example, the spectrum of the preconditioned matrix can be made as close as possible to that of the identity. Denoting by $\sigma(A)$ the spectrum of A , and by \mathbb{P}_k the space of polynomials of degree not exceeding k , the following may be solved.

Find $s \in \mathbb{P}_k$ which minimizes:

$$\max_{\lambda \in \sigma(A)} |1 - \lambda s(\lambda)|. \quad (12.4)$$

Unfortunately, this problem involves all the eigenvalues of A and is harder to solve than the original problem. Usually, problem (12.4) is replaced by the problem

Find $s \in \mathbb{P}_k$ which minimizes:

$$\max_{\lambda \in E} |1 - \lambda s(\lambda)|, \quad (12.5)$$

which is obtained from replacing the set $\sigma(A)$ by some continuous set E that encloses it. Thus, a rough idea of the spectrum of the matrix A is needed. Consider first the particular case where A is Symmetric Positive Definite, in which case E can be taken to be an interval $[\alpha, \beta]$ containing the eigenvalues of A .

A variation of Theorem 6.4 is that for any real scalar γ such with $\gamma \leq \alpha$, the minimum

$$\min_{p \in \mathbb{P}_k, p(\gamma)=1} \max_{t \in [\alpha, \beta]} |p(t)|$$

is reached for the shifted and scaled Chebyshev polynomial of the first kind,

$$\hat{C}_k(t) \equiv \frac{C_k \left(1 + 2 \frac{\alpha-t}{\beta-\alpha} \right)}{C_k \left(1 + 2 \frac{\alpha-\gamma}{\beta-\alpha} \right)}.$$

Of interest is the case where $\gamma = 0$ which gives the polynomial

$$T_k(t) \equiv \frac{1}{\sigma_k} C_k \left(\frac{\beta + \alpha - 2t}{\beta - \alpha} \right) \quad \text{with} \quad \sigma_k \equiv C_k \left(\frac{\beta + \alpha}{\beta - \alpha} \right).$$

Denote the center and mid-width of the interval $[\alpha, \beta]$, respectively, by

$$\theta \equiv \frac{\beta + \alpha}{2}, \quad \delta \equiv \frac{\beta - \alpha}{2}.$$

Using these parameters instead of α, β , the above expressions then become

$$T_k(t) \equiv \frac{1}{\sigma_k} C_k \left(\frac{\theta - t}{\delta} \right) \quad \text{with} \quad \sigma_k \equiv C_k \left(\frac{\theta}{\delta} \right).$$

The three-term recurrence for the Chebyshev polynomials results in the following three-term recurrences:

$$\sigma_{k+1} = 2 \frac{\theta}{\delta} \sigma_k - \sigma_{k-1}, \quad k = 1, 2, \dots,$$

with

$$\sigma_1 = \frac{\theta}{\delta}, \quad \sigma_0 = 1,$$

and

$$\begin{aligned} T_{k+1}(t) &\equiv \frac{1}{\sigma_{k+1}} \left[2 \frac{\theta - t}{\delta} \sigma_k T_k(t) - \sigma_{k-1} T_{k-1}(t) \right] \\ &= \frac{\sigma_k}{\sigma_{k+1}} \left[2 \frac{\theta - t}{\delta} T_k(t) - \frac{\sigma_{k-1}}{\sigma_k} T_{k-1}(t) \right], \quad k \geq 1, \end{aligned}$$

with

$$T_1(t) = 1 - \frac{t}{\theta}, \quad T_0(t) = 1.$$

Define

$$\rho_k \equiv \frac{\sigma_k}{\sigma_{k+1}}, \quad k = 1, 2, \dots \quad (12.6)$$

Note that the above recurrences can be put together as

$$\rho_k = \frac{1}{2\sigma_1 - \rho_{k-1}} \quad (12.7)$$

$$T_{k+1}(t) = \rho_k \left[2 \left(\sigma_1 - \frac{t}{\delta} \right) T_k(t) - \rho_{k-1} T_{k-1}(t) \right], \quad k \geq 1. \quad (12.8)$$

Observe that formulas (12.7–12.8) can be started at $k = 0$ provided we set $T_{-1} \equiv 0$ and $\rho_{-1} \equiv 0$, so that $\rho_0 = 1/(2\sigma_1)$.

The goal is to obtain an iteration that produces a residual vector of the form $r_{k+1} = T_{k+1}(A)r_0$ where T_k is the polynomial defined by the above recurrence. The difference between two successive residual vectors is given by

$$r_{k+1} - r_k = (T_{k+1}(A) - T_k(A))r_0.$$

The identity $1 = (2\sigma_1 - \rho_{k-1})\rho_k$ and the relations (12.8) yield

$$T_{k+1}(t) - T_k(t) = T_{k+1}(t) - (2\sigma_1 - \rho_{k-1})\rho_k T_k(t)$$

$$= \rho_k \left[-\frac{2t}{\delta} T_k(t) + \rho_{k-1} (T_k(t) - T_{k-1}(t)) \right].$$

As a result,

$$\frac{T_{k+1}(t) - T_k(t)}{t} = \rho_k \left[\rho_{k-1} \frac{T_k(t) - T_{k-1}(t)}{t} - \frac{2}{\delta} T_k(t) \right]. \quad (12.9)$$

Define

$$d_k \equiv x_{k+1} - x_k,$$

and note that $r_{k+1} - r_k = Ad_k$. If $x_{k+1} = x_0 + s_k(A)r_0$, then $r_{k+1} = (I - As_k(A))r_0$, and $d_k = A^{-1}(T_{k+1}(A) - T_k(A))r_0$. Therefore the relation (12.9) translates into the recurrence,

$$d_k = \rho_k \left[\rho_{k-1} d_{k-1} - \frac{2}{\delta} r_k \right].$$

Finally, the following algorithm is obtained.

ALGORITHM 12.1: Chebyshev Acceleration

1. $r_0 = b - Ax_0; \sigma_1 = \delta/\theta;$
 2. $\rho_0 = 1/\sigma_1; d_0 = \frac{1}{\theta}r_0;$
 3. For $k = 0, \dots$, until convergence Do:
 4. $x_{k+1} = x_k + d_k$
 5. $r_{k+1} = r_k - Ad_k$
 6. $\rho_{k+1} = (2\sigma_1 - \rho_k)^{-1};$
 7. $d_{k+1} = \rho_{k+1}\rho_k d_k - \frac{2\rho_{k+1}}{\delta}r_{k+1}$
 8. EndDo
-

Lines 7 and 4 can also be recast into one single update of the form

$$x_{k+1} = x_k + \rho_k \left[\rho_{k-1} (x_k - x_{k-1}) - \frac{2}{\delta} (b - Ax_k) \right].$$

It can be shown that when $\alpha = \lambda_1$ and $\beta = \lambda_N$, the resulting preconditioned matrix minimizes the condition number of the preconditioned matrices of the form $As(A)$ over all polynomials s of degree $\leq k-1$. However, when used in conjunction with the Conjugate Gradient method, it is observed that the polynomial which minimizes the total number of Conjugate Gradient iterations *is far from being the one which minimizes the condition number*. If instead of taking $\alpha = \lambda_1$ and $\beta = \lambda_N$, the interval $[\alpha, \beta]$ is chosen to be slightly inside the interval $[\lambda_1, \lambda_N]$, a much faster convergence might be achieved. The true optimal parameters, i.e., those that minimize the number of iterations of the polynomial preconditioned Conjugate Gradient method, are difficult to determine in practice.

There is a slight disadvantage to the approaches described above. The parameters α and β , which approximate the smallest and largest eigenvalues of A , are usually not available beforehand and must be obtained in some dynamic way. This may be a problem mainly because a software code based on Chebyshev acceleration could become quite complex.

To remedy this, one may ask whether the values provided by an application of Gershgorin's theorem can be used for α and β . Thus, in the symmetric case, the parameter α , which *estimates* the smallest eigenvalue of A , may be nonpositive even when A is a positive definite matrix. However, when $\alpha \leq 0$, the problem of minimizing (12.5) is not well defined, since it does not have a unique solution due to the non strict-convexity of the uniform norm. An alternative uses the L_2 -norm on $[\alpha, \beta]$ with respect to some weight function $w(\lambda)$. This "least-squares" polynomials approach is considered next.

12.3.3 LEAST-SQUARES POLYNOMIALS

Consider the inner product on the space \mathbb{P}_k :

$$\langle p, q \rangle = \int_{\alpha}^{\beta} p(\lambda)q(\lambda)w(\lambda)d\lambda \quad (12.10)$$

where $w(\lambda)$ is some non-negative weight function on (α, β) . Denote by $\|p\|_w$ and call w -norm, the 2-norm induced by this inner product.

We seek the polynomial s_{k-1} which minimizes

$$\|1 - \lambda s(\lambda)\|_w \quad (12.11)$$

over all polynomials s of degree $\leq k-1$. Call s_{k-1} the *least-squares iteration polynomial*, or simply the least-squares polynomial, and refer to $R_k(\lambda) \equiv 1 - \lambda s_{k-1}(\lambda)$ as the least-squares residual polynomial. A crucial observation is that the least squares polynomial is well defined for arbitrary values of α and β . Computing the polynomial $s_{k-1}(\lambda)$ is not a difficult task when the weight function w is suitably chosen.

Computation of the least-squares polynomials There are three ways to compute the least-squares polynomial s_k defined in the previous section. The first approach is to use an explicit formula for R_k , known as the kernel polynomials formula,

$$R_k(\lambda) = \frac{\sum_{i=0}^k q_i(0)q_i(\lambda)}{\sum_{i=0}^k q_i(0)^2} \quad (12.12)$$

in which the q_i 's represent a sequence of polynomials orthogonal with respect to the weight function $w(\lambda)$. The second approach generates a three-term recurrence satisfied by the residual polynomials $R_k(\lambda)$. These polynomials are orthogonal with respect to the weight function $\lambda w(\lambda)$. From this three-term recurrence, we can proceed exactly as for the Chebyshev iteration to obtain a recurrence formula for the sequence of approximate solutions x_k . Finally, a third approach solves the Normal Equations associated with the minimization of (12.11), namely,

$$\langle 1 - \lambda s_{k-1}(\lambda), \lambda Q_j(\lambda) \rangle = 0, j = 0, 1, 2, \dots, k-1$$

where $Q_j, j = 1, \dots, k-1$ is any basis of the space P_{k-1} of polynomials of degree $\leq k-1$.

These three approaches can all be useful in different situations. For example, the first approach can be useful for computing least-squares polynomials of low degree explicitly. For high-degree polynomials, the last two approaches are preferable for their better numer-

ical behavior. The second approach is restricted to the case where $\alpha \geq 0$, while the third is more general.

Since the degrees of the polynomial preconditioners are often low, e.g., not exceeding 5 or 10, we will give some details on the first formulation. Let $q_i(\lambda)$, $i = 0, 1, \dots, n, \dots$, be the *orthonormal* polynomials with respect to $w(\lambda)$. It is known that the least-squares residual polynomial $R_k(\lambda)$ of degree k is determined by the kernel polynomials formula (12.12). To obtain $s_{k-1}(\lambda)$, simply notice that

$$s_{k-1}(\lambda) = \frac{1 - R_k(\lambda)}{\lambda} = \frac{\sum_{i=0}^k q_i(0)t_i(\lambda)}{\sum_{i=0}^k q_i(0)^2}, \quad \text{with} \quad (12.13)$$

$$t_i(\lambda) = \frac{q_i(0) - q_i(\lambda)}{\lambda}. \quad (12.14)$$

This allows s_{k-1} to be computed as a linear combination of the polynomials $t_i(\lambda)$. Thus, we can obtain the desired least-squares polynomials from the sequence of orthogonal polynomials q_i which satisfy a three-term recurrence of the form:

$$\beta_{i+1}q_{i+1}(\lambda) = (\lambda - \alpha_i)q_i(\lambda) - \beta_iq_{i-1}(\lambda), i = 1, 2, \dots$$

From this, the following recurrence for the t_i 's can be derived:

$$\beta_{i+1}t_{i+1}(\lambda) = (\lambda - \alpha_i)t_i(\lambda) - \beta_it_{i-1}(\lambda) + q_i(0), i = 1, 2, \dots$$

The weight function w is chosen so that the three-term recurrence of the orthogonal polynomials q_i is known explicitly and/or is easy to generate. An interesting class of weight functions that satisfy this requirement is considered next.

Choice of the weight functions This section assumes that $\alpha = 0$ and $\beta = 1$. Consider the Jacobi weights

$$w(\lambda) = \lambda^{\mu-1}(1 - \lambda)^\nu, \text{ where } \mu > 0 \text{ and } \nu \geq -\frac{1}{2}. \quad (12.15)$$

For these weight functions, the recurrence relations are known explicitly for the polynomials that are orthogonal with respect to $w(\lambda)$, $\lambda w(\lambda)$, or $\lambda^2 w(\lambda)$. This allows the use of any of the three methods described in the previous section for computing $s_{k-1}(\lambda)$. Moreover, it has been shown [129] that the preconditioned matrix $As_k(A)$ is Symmetric Positive Definite when A is Symmetric Positive Definite, provided that $\mu - 1 \geq \nu \geq -\frac{1}{2}$.

The following explicit formula for $R_k(\lambda)$ can be derived easily from the explicit expression of the Jacobi polynomials and the fact that $\{R_k\}$ is orthogonal with respect to the weight $\lambda w(\lambda)$:

$$R_k(\lambda) = \sum_{j=0}^k \kappa_j^{(k)} (1 - \lambda)^{k-j} (-\lambda)^j \quad (12.16)$$

$$\kappa_j^{(k)} = \binom{k}{j} \prod_{i=0}^{j-1} \frac{k - i + \nu}{i + 1 + \mu}.$$

Using (12.13), the polynomial $s_{k-1}(\lambda) = (1 - R_k(\lambda))/\lambda$ can be derived easily “by hand” for small degrees; see Exercise 4.

Example 12.1 As an illustration, we list the least-squares polynomials s_k for $k = 1, \dots, 8$, obtained for the Jacobi weights with $\mu = \frac{1}{2}$ and $\nu = -\frac{1}{2}$. The polynomials listed are for the interval $[0, 4]$ as this leads to integer coefficients. For a general interval $[0, \beta]$, the best polynomial of degree k is $s_k(4\lambda/\beta)$. Also, each polynomial s_k is rescaled by $(3 + 2k)/4$ to simplify the expressions. However, this scaling factor is unimportant if these polynomials are used for preconditioning.

	1	λ	λ^2	λ^3	λ^4	λ^5	λ^6	λ^7	λ^8
s_1	5	-1							
s_2	14	-7	1						
s_3	30	-27	9	-1					
s_4	55	-77	44	-11	1				
s_5	91	-182	156	-65	13	-1			
s_6	140	-378	450	-275	90	-15	1		
s_7	204	-714	1122	-935	442	-119	17	-1	
s_8	285	-1254	2508	-2717	1729	-665	152	-19	1

We selected $\mu = \frac{1}{2}$ and $\nu = -\frac{1}{2}$ only because these choices lead to a very simple recurrence for the polynomials q_i , which are the Chebyshev polynomials of the first kind.

Theoretical considerations An interesting theoretical question is whether the least-squares residual polynomial becomes small in some sense as its degree increases. Consider first the case $0 < \alpha < \beta$. Since the residual polynomial R_k minimizes the norm $\|R\|_w$ associated with the weight w , over all polynomials R of degree $\leq k$ such that $R(0) = 1$, the polynomial $(1 - (\lambda/\theta))^k$ with $\theta = (\alpha + \beta)/2$ satisfies

$$\|R_k\|_w \leq \left\| \left(1 - \frac{\lambda}{c} \right)^k \right\|_w \leq \left\| \left[\frac{b-a}{b+a} \right]^k \right\|_w = \kappa \left[\frac{\beta - \alpha}{\beta + \alpha} \right]^k$$

where κ is the w -norm of the function unity on the interval $[\alpha, \beta]$. The norm of R_k will tend to zero geometrically as k tends to infinity, provided $\alpha > 0$.

Consider now the case $\alpha = 0, \beta = 1$ and the Jacobi weight (12.15). For this choice of the weight function, the least-squares residual polynomial is known to be $p_k(\lambda)/p_k(0)$ where p_k is the k^{th} degree Jacobi polynomial associated with the weight function $w'(\lambda) = \lambda^\mu(1 - \lambda)^\nu$. It can be shown that the 2-norm of such a residual polynomial with respect to this weight is given by

$$\|p_k/p_k(0)\|_{w'}^2 = \frac{\Gamma^2(\mu + 1)\Gamma(k + \nu + 1)}{(2k + \mu + \nu + 1)(\Gamma(k + \mu + \nu + 1))\Gamma(k + \mu + 1)}$$

in which Γ is the Gamma function. For the case $\mu = \frac{1}{2}$ and $\nu = -\frac{1}{2}$, this becomes

$$\|p_k/p_k(0)\|_{w'}^2 = \frac{[\Gamma(\frac{3}{2})]^2}{(2k + 1)(k + \frac{1}{2})} = \frac{\pi}{2(2k + 1)^2}$$

Therefore, the w' -norm of the least-squares residual polynomial converges to zero like $1/k$ as the degree k increases (a much slower rate than when $\alpha > 0$). However, note that the condition $p(0) = 1$ implies that the polynomial must be large in some interval around the

origin.

12.3.4 THE NONSYMMETRIC CASE

Given a set of approximate eigenvalues of a nonsymmetric matrix A , a simple region E can be constructed in the complex plane, e.g., a disk, an ellipse, or a polygon, which encloses the spectrum of the matrix A . There are several choices for E . The first idea uses an ellipse E that encloses an approximate convex hull of the spectrum. Consider an ellipse centered at θ , and with focal distance δ . Then as seen in Chapter 6, the shifted and scaled Chebyshev polynomials defined by

$$T_k(\lambda) = \frac{C_k\left(\frac{\theta-\lambda}{\delta}\right)}{C_k\left(\frac{\theta}{\delta}\right)}$$

are nearly optimal. The use of these polynomials leads again to an attractive three-term recurrence and to an algorithm similar to Algorithm 12.1. In fact, the recurrence is identical, except that the scalars involved can now be complex to accommodate cases where the ellipse has foci not necessarily located on the real axis. However, when A is real, then the symmetry of the foci with respect to the real axis can be exploited. The algorithm can still be written in real arithmetic.

An alternative to Chebyshev polynomials over ellipses employs a polygon H that contains $\sigma(A)$. Polygonal regions may better represent the shape of an arbitrary spectrum. The best polynomial for the infinity norm is not known explicitly but it may be computed by an algorithm known in approximation theory as the Remez algorithm. It may be simpler to use an L_2 -norm instead of the infinity norm, i.e., to solve (12.11) where w is some weight function defined on the boundary of the polygon H .

Now here is a sketch of an algorithm based on this approach. We use an L_2 -norm associated with Chebyshev weights on the edges of the polygon. If the contour of H consists of k edges each with center θ_i and half-length δ_i , then the weight on each edge is defined by

$$w_i(\lambda) = \frac{2}{\pi} |\delta_i - (\lambda - \theta_i)^2|^{-1/2}, \quad i = 1, \dots, k. \quad (12.17)$$

Using the power basis to express the best polynomial is not a safe practice. It is preferable to use the Chebyshev polynomials associated with the ellipse of smallest area containing H . With the above weights or any other Jacobi weights on the edges, there is a finite procedure *which does not require numerical integration* to compute the best polynomial. To do this, each of the polynomials of the basis (namely, the Chebyshev polynomials associated with the ellipse of smallest area containing H) must be expressed as a linear combination of the Chebyshev polynomials associated with the different intervals $[\theta_i - \delta_i, \theta_i + \delta_i]$. This redundancy allows exact expressions for the integrals involved in computing the least-squares solution to (12.11).

Next, the main lines of a preconditioned GMRES algorithm are described based on least-squares polynomials. Eigenvalue estimates are obtained from a GMRES step at the beginning of the outer loop. This GMRES adaptive corrects the current solution and the eigenvalue estimates are used to update the current polygon H . Correcting the solution at this stage is particularly important since it often results in a few orders of magnitude

improvement. This is because the polygon H may be inaccurate and the residual vector is dominated by components in one or two eigenvectors. The GMRES step will immediately annihilate those dominating components. In addition, the eigenvalues associated with these components will now be accurately represented by eigenvalues of the Hessenberg matrix.

ALGORITHM 12.2: Polynomial Preconditioned GMRES

1. Start or Restart:
 2. Compute current residual vector $r := b - Ax$.
 3. Adaptive GMRES step:
 4. Run m_1 steps of GMRES for solving $Ad = r$.
 5. Update x by $x := x + d$.
 6. Get eigenvalue estimates from the eigenvalues of the
 7. Hessenberg matrix.
 8. Compute new polynomial:
 9. Refine H from previous hull H and new eigenvalue estimates.
 10. Get new best polynomial s_k .
 11. Polynomial Iteration:
 12. Compute the current residual vector $r = b - Ax$.
 13. Run m_2 steps of GMRES applied to $s_k(A)Ad = s_k(A)r$.
 14. Update x by $x := x + d$.
 15. Test for convergence.
 16. If solution converged then Stop; else GoTo 1.
-

Example 12.2 Table 12.1 shows the results of applying GMRES(20) with polynomial preconditioning to the first four test problems described in Section 3.7.

Matrix	Iters	Kflops	Residual	Error
F2DA	56	2774	0.22E-05	0.51E-06
F3D	22	7203	0.18E-05	0.22E-05
ORS	78	4454	0.16E-05	0.32E-08
F2DB	100	4432	0.47E-05	0.19E-05

Table 12.1 A test run of $ILU(0)$ -GMRES accelerated with polynomial preconditioning.

See Example 6.1 for the meaning of the column headers in the table. In fact, the system is preconditioned by $ILU(0)$ before polynomial preconditioning is applied to it. Degree 10 polynomials (maximum) are used. The tolerance for stopping is 10^{-7} . Recall that *Iters* is the number of matrix-by-vector products rather than the number of GMRES iterations. Notice that, for most cases, the method does not compare well with the simpler $ILU(0)$ example seen in Chapter 10. The notable exception is example F2DB for which the method converges fairly fast in contrast with the simple $ILU(0)$ -GMRES; see Example 10.2. An attempt to use the method for the fifth matrix in the test set, namely, the FIDAP matrix FID, failed because the matrix has eigenvalues on both sides of the imaginary axis and the code tested does not handle this situation.

It is interesting to follow the progress of the algorithm in the above examples. For the first example, the coordinates of the vertices of the upper part of the first polygon H are

$\Re(c_i)$	$\Im(c_i)$
0.06492	0.00000
0.17641	0.02035
0.29340	0.03545
0.62858	0.04977
1.18052	0.00000

This hull is computed from the 20 eigenvalues of the 20×20 Hessenberg matrix resulting from the first run of GMRES(20). In the ensuing GMRES loop, the outer iteration converges in three steps, each using a polynomial of degree 10, i.e., there is no further adaptation required. For the second problem, the method converges in the 20 first steps of GMRES, so polynomial acceleration was never invoked. For the third example, the initial convex hull found is the interval $[0.06319, 1.67243]$ of the real line. The polynomial preconditioned GMRES then converges in five iterations. Finally, the initial convex hull found for the last example is

$\Re(c_i)$	$\Im(c_i)$
0.17131	0.00000
0.39337	0.10758
1.43826	0.00000

and the outer loop converges again without another adaptation step, this time in seven steps.

MULTICOLORING

12.4

The general idea of multicoloring, or graph coloring, has been used for a long time by numerical analysts. It was exploited, in particular, in the context of relaxation techniques both for understanding their theory and for deriving efficient algorithms. More recently, these techniques were found to be useful in improving parallelism in iterative solution techniques. This discussion begins with the 2-color case, called *red-black* ordering.

12.4.1 RED-BLACK ORDERING

The problem addressed by multicoloring is to determine a coloring of the nodes of the adjacency graph of a matrix such that any two adjacent nodes have different colors. For a 2-dimensional finite difference grid (5-point operator), this can be achieved with two

colors, typically referred to as “red” and “black.” This red-black coloring is illustrated in Figure 12.2 for a 6×4 mesh where the black nodes are represented by filled circles.

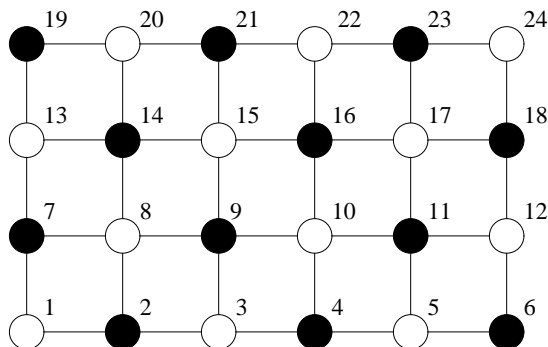

Figure 12.2 Red-black coloring of a 6×4 grid. Natural labeling of the nodes.

Assume that the unknowns are labeled by listing the red unknowns first together, followed by the black ones. The new labeling of the unknowns is shown in Figure 12.3.

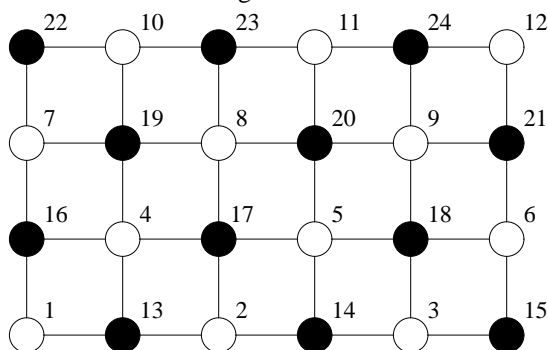

Figure 12.3 Red-black coloring of a 6×4 grid. Red-black labeling of the nodes.

Since the red nodes are not coupled with other red nodes and, similarly, the black nodes are not coupled with other black nodes, the system that results from this reordering will have the structure

$$\begin{pmatrix} D_1 & F \\ E & D_2 \end{pmatrix} \begin{pmatrix} x_1 \\ x_2 \end{pmatrix} = \begin{pmatrix} b_1 \\ b_2 \end{pmatrix}, \quad (12.18)$$

in which D_1 and D_2 are diagonal matrices. The reordered matrix associated with this new labeling is shown in Figure 12.4.

Two issues will be explored regarding red-black ordering. The first is how to exploit this structure for solving linear systems. The second is how to generalize this approach for systems whose graphs are not necessarily 2-colorable.

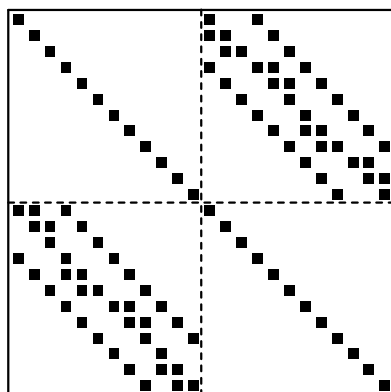

Figure 12.4 Matrix associated with the red-black reordering of Figure 12.3.

12.4.2 SOLUTION OF RED-BLACK SYSTEMS

The easiest way to exploit the red-black ordering is to use the standard SSOR or ILU(0) preconditioners for solving the block system (12.18) which is derived from the original system. The resulting preconditioning operations are highly parallel. For example, the linear system that arises from the forward solve in SSOR will have the form

$$\begin{pmatrix} D_1 & O \\ E & D_2 \end{pmatrix} \begin{pmatrix} x_1 \\ x_2 \end{pmatrix} = \begin{pmatrix} b_1 \\ b_2 \end{pmatrix}.$$

This system can be solved by performing the following sequence of operations:

1. Solve $D_1 x_1 = b_1$.
2. Compute $\hat{b}_2 := b_2 - E x_1$.
3. Solve $D_2 x_2 = \hat{b}_2$.

This consists of two diagonal scalings (operations 1 and 3) and a sparse matrix-by-vector product. Therefore, the degree of parallelism, is at least $n/2$ if an atomic task is considered to be any arithmetic operation. The situation is identical with the ILU(0) preconditioning. However, since the matrix has been reordered before ILU(0) is applied to it, the resulting LU factors are not related in any simple way to those associated with the original matrix. In fact, a simple look at the structure of the ILU factors reveals that many more elements are dropped with the red-black ordering than with the natural ordering. The result is that the number of iterations to achieve convergence can be much higher with red-black ordering than with the natural ordering.

A second method that has been used in connection with the red-black ordering solves the reduced system which involves only the black unknowns. Eliminating the red unknowns from (12.18) results in the reduced system:

$$(D_2 - ED_1^{-1}F)x_2 = b_2 - ED_1^{-1}b_1.$$

Note that this new system is again a sparse linear system with about half as many unknowns. In addition, it has been observed that for “easy problems,” the reduced system can often be solved efficiently with only diagonal preconditioning. The computation of the reduced system is a highly parallel and inexpensive process. Note that it is not necessary to form the reduced system. This strategy is more often employed when D_1 is not diagonal, such as in domain decomposition methods, but it can also have some uses in other situations. For example, applying the matrix to a given vector x can be performed using nearest-neighbor communication, and this can be more efficient than the standard approach of multiplying the vector by the Schur complement matrix $D_2 - ED_1^{-1}F$. In addition, this can save storage, which may be more critical in some cases.

12.4.3 MULTICOLORING FOR GENERAL SPARSE MATRICES

Chapter 3 discussed a general greedy approach for multicoloring a graph. Given a general sparse matrix A , this inexpensive technique allows us to reorder it into a block form where the diagonal blocks are diagonal matrices. The number of blocks is the number of colors. For example, for six colors, a matrix would result with the structure shown in Figure 12.5 where the D_i 's are diagonal and E, F are general sparse. This structure is obviously a generalization of the red-black ordering.

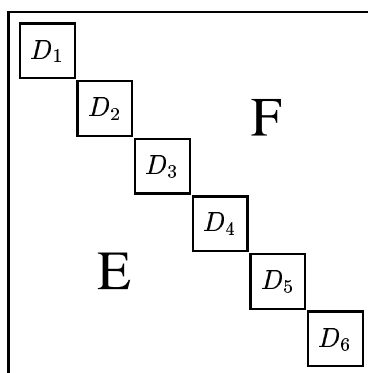

Figure 12.5 A six-color ordering of a general sparse matrix.

Just as for the red-black ordering, ILU(0), SOR, or SSOR preconditioning can be used on this reordered system. The parallelism of SOR/SSOR is now of order n/p where p is the number of colors. A loss in efficiency may occur since the number of iterations is likely to increase.

A Gauss-Seidel sweep will essentially consist of p scalings and $p - 1$ matrix-by-vector products, where p is the number of colors. Specifically, assume that the matrix is stored in the well known Ellpack-Itpack format and that the block structure of the permuted matrix is defined by a pointer array $iptr$. The index $iptr(j)$ is the index of the first row in the j -th block. Thus, the pair $A(n1 : n2, *)$, $JA(n1 : n2, *)$ represents the sparse matrix consisting of the rows $n1$ to $n2$ in the Ellpack-Itpack format. The main diagonal of A is assumed to

be stored separately in inverted form in a one-dimensional array *diag*. One single step of the multicolor SOR iteration will then take the following form.

ALGORITHM 12.3: Multicolor SOR Sweep in the Ellpack Format

```

1. Do col = 1, ncol
2.   n1 = iptr(col)
3.   n2 = iptr(col+1) - 1
4.   y(n1:n2) = rhs(n1:n2)
5.   Do j = 1, ndiag
6.     Do i = n1, n2
7.       y(i) = y(i) - a(i,j)*y(ja(i,j))
8.     EndDo
9.   EndDo
10.  y(n1:n2) = diag(n1:n2) * y(n1:n2)
11. EndDo

```

In the above algorithm, *ncol* is the number of colors. The integers *n1* and *n2* set in lines 2 and 3 represent the beginning and the end of block *col*. In line 10, $y(n1 : n2)$ is multiplied by the diagonal D^{-1} which is kept in inverted form in the array *diag*. The outer loop, i.e., the loop starting in line 1, is sequential. The loop starting in line 6 is vectorizable/parallelizable. There is additional parallelism which can be extracted in the combination of the two loops starting in lines 5 and 6.

MULTI-ELIMINATION ILU

12.5

The discussion in this section begins with the Gaussian elimination algorithm for a general sparse linear system. Parallelism in sparse Gaussian elimination can be obtained by finding unknowns that are independent at a given stage of the elimination, i.e., unknowns that do not depend on each other according to the binary relation defined by the graph of the matrix. A set of unknowns of a linear system which are independent is called an independent set. Thus, independent set orderings can be viewed as permutations to put the original matrix in the form

$$\begin{pmatrix} D & E \\ F & C \end{pmatrix} \quad (12.19)$$

in which *D* is diagonal, but *C* can be arbitrary. This amounts to a less restrictive form of multicoloring, in which a set of vertices in the adjacency graph is found so that no equation in the set involves unknowns from the same set. A few algorithms for finding independent set orderings of a general sparse graph were discussed in Chapter 3.

The rows associated with an independent set can be used as pivots simultaneously. When such rows are eliminated, a smaller linear system results, which is again sparse. Then we can find an independent set for this reduced system and repeat the process of

reduction. The resulting second reduced system is called the second-level reduced system. The process can be repeated recursively a few times. As the level of the reduction increases, the reduced systems gradually lose their sparsity. A direct solution method would continue the reduction until the reduced system is small enough or dense enough to switch to a dense Gaussian elimination to solve it. This process is illustrated in Figure 12.6. There exists a number of sparse direct solution techniques based on this approach.

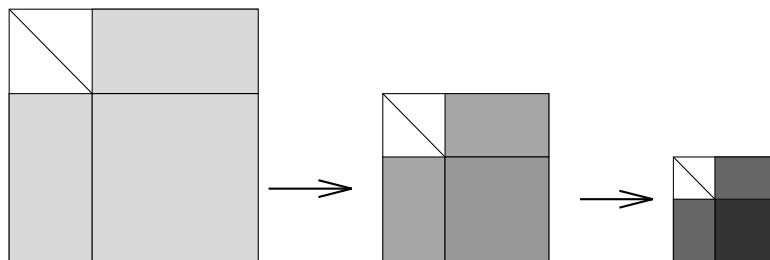

Figure 12.6 Illustration of two levels of multi-elimination for sparse linear systems.

After a brief review of the direct solution method based on independent set orderings, we will explain how to exploit this approach for deriving incomplete LU factorizations by incorporating drop tolerance strategies.

12.5.1 MULTI-ELIMINATION

We start by a discussion of an *exact* reduction step. Let A_j be the matrix obtained at the j -th step of the reduction, $j = 0, \dots, nlev$ with $A_0 = A$. Assume that an independent set ordering is applied to A_j and that the matrix is permuted accordingly as follows:

$$P_j A_j P_j^T = \begin{pmatrix} D_j & F_j \\ E_j & C_j \end{pmatrix} \quad (12.20)$$

where D_j is a diagonal matrix. Now eliminate the unknowns of the independent set to get the next reduced matrix,

$$A_{j+1} = C_j - E_j D_j^{-1} F_j. \quad (12.21)$$

This results, implicitly, in a block LU factorization

$$P_j A_j P_j^T = \begin{pmatrix} D_j & F_j \\ E_j & C_j \end{pmatrix} = \begin{pmatrix} I & O \\ E_j D_j^{-1} & I \end{pmatrix} \times \begin{pmatrix} D_j & F_j \\ O & A_{j+1} \end{pmatrix}$$

with A_{j+1} defined above. Thus, in order to solve a system with the matrix A_j , both a forward and a backward substitution need to be performed with the block matrices on the right-hand side of the above system. The backward solution involves solving a system with the matrix A_{j+1} .

This block factorization approach can be used recursively until a system results that is small enough to be solved with a standard method. The transformations used in the elimination process, i.e., the matrices $E_j D_j^{-1}$ and the matrices F_j must be saved. The permutation

matrices P_j can also be saved. Alternatively, the matrices involved in the factorization at each new reordering step can be permuted explicitly.

12.5.2 ILUM

The successive reduction steps described above will give rise to matrices that become more and more dense due to the fill-ins introduced by the elimination process. In iterative methods, a common cure for this is to neglect some of the fill-ins introduced by using a simple dropping strategy as the reduced systems are formed. For example, any fill-in element introduced is dropped, whenever its size is less than a given tolerance times the 2-norm of the original row. Thus, an “approximate” version of the successive reduction steps can be used to provide an approximate solution $M^{-1}v$ to $A^{-1}v$ for any given v . This can be used to precondition the original linear system. Conceptually, the modification leading to an “incomplete” factorization replaces (12.21) by

$$A_{j+1} = (C_j - E_j D_j^{-1} F_j) - R_j \quad (12.22)$$

in which R_j is the matrix of the elements that are dropped in this reduction step. Globally, the algorithm can be viewed as a form of incomplete block LU with permutations.

Thus, there is a succession of block ILU factorizations of the form

$$\begin{aligned} P_j A_j P_j^T &= \begin{pmatrix} D_j & F_j \\ E_j & C_j \end{pmatrix} \\ &= \begin{pmatrix} I & O \\ E_j D_j^{-1} & I \end{pmatrix} \times \begin{pmatrix} D_j & F_j \\ O & A_{j+1} \end{pmatrix} + \begin{pmatrix} O & O \\ O & R_j \end{pmatrix} \end{aligned}$$

with A_{j+1} defined by (12.22). An independent set ordering for the new matrix A_{j+1} will then be found and this matrix is reduced again in the same manner. It is not necessary to save the successive A_j matrices, but only the last one that is generated. We need also to save the sequence of sparse matrices

$$B_{j+1} = \begin{pmatrix} D_j & F_j \\ E_j D_j^{-1} & O \end{pmatrix} \quad (12.23)$$

which contain the transformation needed at level j of the reduction. The successive permutation matrices P_j can be discarded if they are applied to the previous B_i matrices as soon as these permutation matrices are known. Then only the global permutation is needed, which is the product of all these successive permutations.

An illustration of the matrices obtained after three reduction steps is shown in Figure 12.7. The original matrix is a 5-point matrix associated with a 15×15 grid and is therefore of size $N = 225$. Here, the successive matrices B_i (with permutations applied) are shown together with the last A_j matrix which occupies the location of the O block in (12.23).

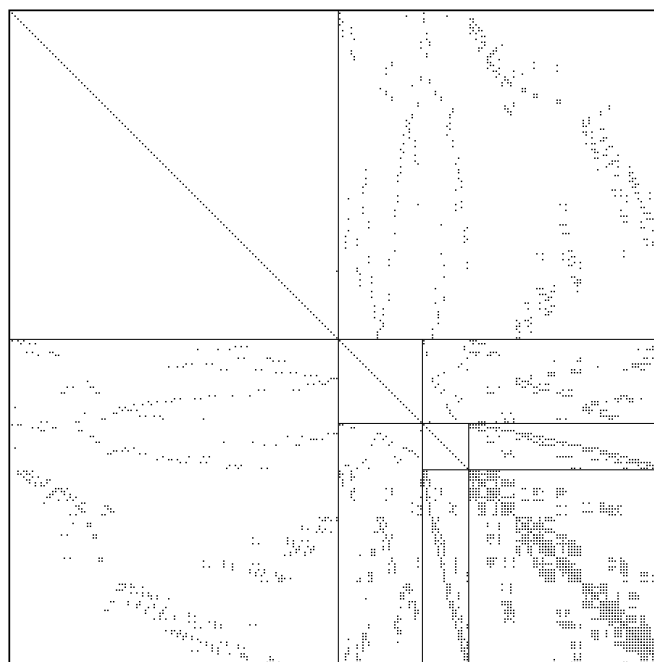

Figure 12.7 Illustration of the processed matrices obtained from three steps of independent set ordering and reductions.

We refer to this incomplete factorization as ILUM (ILU with Multi-Elimination). The preprocessing phase consists of a succession of $nlev$ applications of the following three steps: (1) finding the independent set ordering, (2) permuting the matrix, and (3) reducing it.

ALGORITHM 12.4: ILUM: Preprocessing Phase

1. Set $A_0 = A$.
 2. For $j = 0, 1, \dots, nlev - 1$ Do:
 3. Find an independent set ordering permutation P_j for A_j ;
 4. Apply P_j to A_j to permute it into the form (12.20);
 5. Apply P_j to B_1, \dots, B_j ;
 6. Apply P_j to P_0, \dots, P_{j-1} ;
 7. Compute the matrices A_{j+1} and B_{j+1} defined by (12.22) and (12.23).
 8. EndDo
-

In the backward and forward solution phases, the last reduced system must be solved but not necessarily with high accuracy. For example, we can solve it according to the level of tolerance allowed in the dropping strategy during the preprocessing phase. Observe that if the linear system is solved inaccurately, only an accelerator that allows variations in the preconditioning should be used. Such algorithms have been discussed in Chapter 9. Alternatively, we can use a fixed number of multicolor SOR or SSOR steps or a fixed polynomial iteration. The implementation of the ILUM preconditioner corresponding to

this strategy is rather complicated and involves several parameters.

In order to describe the forward and backward solution, we introduce some notation. We start by applying the “global permutation,” i.e., the product

$$P_{nlev-1}, P_{nlev-2} \cdots, P_0$$

to the right-hand side. We overwrite the result on the current solution vector, an N -vector called x_0 . Now partition this vector into

$$x_0 = \begin{pmatrix} y_0 \\ x_1 \end{pmatrix}$$

according to the partitioning (12.20). The forward step consists of transforming the second component of the right-hand side as

$$x_1 := x_1 - E_0 D_0^{-1} y_0.$$

Now x_1 is partitioned in the same manner as x_0 and the forward elimination is continued the same way. Thus, at each step, each x_j is partitioned as

$$x_j = \begin{pmatrix} y_j \\ x_{j+1} \end{pmatrix}.$$

A forward elimination step defines the new x_{j+1} using the old x_{j+1} and y_j for $j = 0, \dots, nlev - 1$ while a backward step defines y_j using the old y_j and x_{j+1} , for $j = nlev - 1, \dots, 0$. Algorithm 12.5 describes the general structure of the forward and backward solution sweeps. Because the global permutation was applied at the beginning, the successive permutations need not be applied. However, the final result obtained must be permuted back into the original ordering.

ALGORITHM 12.5: ILUM: Forward and Backward Solutions

1. Apply global permutation to right-hand-side b and copy into x_0 .
 2. For $j = 0, 1, \dots, nlev - 1$ Do: [Forward sweep]
 3. $x_{j+1} := x_{j+1} - E_j D_j^{-1} y_j$
 4. EndDo
 5. Solve with a relative tolerance ϵ :
 6. $A_{nlev} x_{nlev} := x_{nlev}$.
 7. For $j = nlev - 1, \dots, 1, 0$ Do: [Backward sweep]
 8. $y_j := D_j^{-1} (y_j - F_j x_{j+1})$.
 9. EndDo
 10. Permute the resulting solution vector back to the original
 11. ordering to obtain the solution x .
-

Computer implementations of ILUM can be rather tedious. The implementation issues are similar to those of parallel direct-solution methods for sparse linear systems.

DISTRIBUTED ILU AND SSOR

12.6

This section describes parallel variants of the block Successive Over-Relaxation (BSOR) and ILU(0) preconditioners which are suitable for distributed memory environments. Chapter 11 briefly discussed *distributed sparse matrices*. A distributed matrix is a matrix whose entries are located in the memories of different processors in a multiprocessor system. These types of data structures are very convenient for distributed memory computers and it is useful to discuss implementations of preconditioners that are specifically developed for them. Refer to Section 11.5.6 for the terminology used here. In particular, the term *subdomain* is used in the very general sense of subgraph. For both ILU and SOR, multicoloring or level scheduling can be used at the macro level, to extract parallelism. Here, macro level means the level of parallelism corresponding to the processors, or blocks, or subdomains.

12.6.1 DISTRIBUTED SPARSE MATRICES

In the ILU(0) factorization, the LU factors have the same nonzero patterns as the original matrix A , so that the references of the entries belonging to the external subdomains in the ILU(0) factorization are identical with those of the matrix-by-vector product operation with the matrix A . This is not the case for the more accurate ILU(p) factorization, with $p > 0$. If an attempt is made to implement a wavefront ILU preconditioner on a distributed memory computer, a difficulty arises because the natural ordering for the original sparse problem may put an unnecessary limit on the amount of parallelism available. Instead, a two-level ordering is used. First, define a “global” ordering which is a wavefront ordering for the subdomains. This is based on the graph which describes the coupling between the subdomains: Two subdomains are coupled if and only if they contain at least a pair of coupled unknowns, one from each subdomain. Then, within each subdomain, define a local ordering.

To describe the possible parallel implementations of these ILU(0) preconditioners, it is sufficient to consider a local view of the distributed sparse matrix, illustrated in Figure 12.8. The problem is partitioned into p subdomains or subgraphs using some graph partitioning technique. This results in a mapping of the matrix into processors where it is assumed that the i -th equation (row) and the i -th unknown are mapped to the same processor. We distinguish between *interior* points and *interface* points. The interior points are those nodes that are not coupled with nodes belonging to other processors. Interface nodes are those local nodes that are coupled with at least one node which belongs to another processor. Thus, processor number 10 in the figure holds a certain number of rows that are local rows. Consider the rows associated with the interior nodes. The unknowns associated with these nodes are not coupled with variables from other processors. As a result, the rows associated with these nodes can be eliminated independently in the ILU(0) process. The rows associated with the nodes on the interface of the subdomain will require more attention. Recall that an ILU(0) factorization is determined entirely by the order in which the rows are processed. The interior nodes can be eliminated first. Once this is done, the interface

rows can be eliminated *in a certain order*. There are two natural choices for this order. The first would be to impose a global order based on the labels of the processors. Thus, in the illustration, the interface rows belonging to Processors 2, 4, and 6 are processed before those in Processor 10. The interface rows in Processor 10 must in turn be processed before those of Processors 13 and 14. The local order, i.e., the order in which we process the interface rows in the same processor (e.g. Processor 10), may not be as important. This global order based on PE-number defines a natural priority graph and parallelism can be exploited easily in a data-driven implementation.

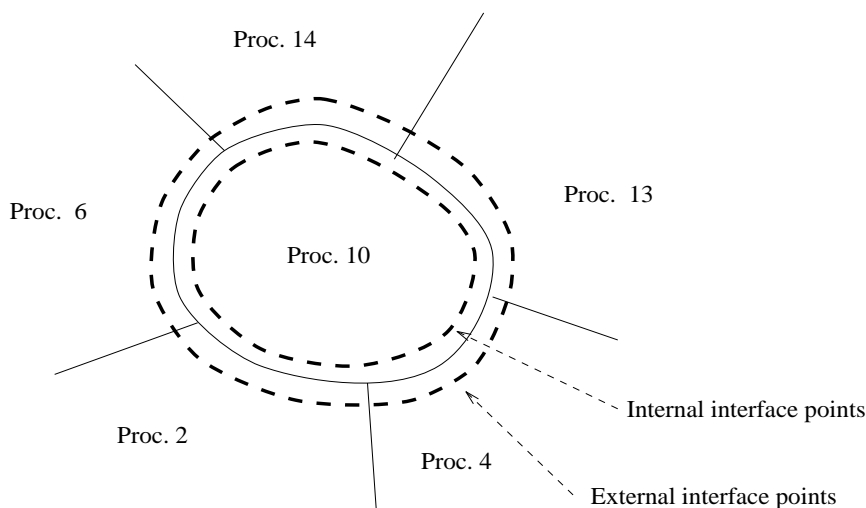

Figure 12.8 A local view of the distributed $ILU(0)$.

It is somewhat unnatural to base the ordering just on the processor labeling. Observe that a proper order can also be defined for performing the elimination by *replacing the PE-numbers with any labels, provided that any two neighboring processors have a different label*. The most natural way to do this is by performing a multicoloring of the subdomains, and using the colors in exactly the same way as before to define an order of the tasks. The algorithms will be written in this general form, i.e., with a label associated with each processor. Thus, the simplest valid labels are the PE numbers, which lead to the PE-label-based order. In the following, we define Lab_j as the label of Processor number j .

ALGORITHM 12.6: Distributed $ILU(0)$ factorization

1. In each processor P_i , $i = 1, \dots, p$ Do:
 2. Perform the $ILU(0)$ factorization for interior local rows.
 3. Receive the factored rows from the adjacent processors j with $Lab_j < Lab_i$.
 4. Perform the $ILU(0)$ factorization for the interface rows with pivots received from the external processors in step 3.
 5. Perform the $ILU(0)$ factorization for the boundary nodes, with pivots from the interior rows completed in step 2.
 6. Send the completed interface rows to adjacent processors j with $Lab_j > Lab_i$.

10. $Lab_j > Lab_i$.
11. *EndDo*

Step 2 of the above algorithm can be performed in parallel because it does not depend on data from other subdomains. Once this distributed ILU(0) factorization is completed, the preconditioned Krylov subspace algorithm will require a forward and backward sweep at each step. The distributed forward/backward solution based on this factorization can be implemented as follows.

ALGORITHM 12.7: Distributed Forward and Backward Sweep

1. *In each processor P_i , $i = 1, \dots, p$ Do:*
2. *Forward solve:*
3. Perform the forward solve for the interior nodes.
4. Receive the updated values from the adjacent processors j
5. with $Lab_j < Lab_i$.
6. Perform the forward solve for the interface nodes.
7. Send the updated values of boundary nodes to the adjacent
8. processors j with $Lab_j > Lab_i$.
9. *Backward solve:*
10. Receive the updated values from the adjacent processors j
11. with $Lab_j > Lab_i$.
12. Perform the backward solve for the boundary nodes.
13. Send the updated values of boundary nodes to the adjacent
14. processors, j with $Lab_j < Lab_i$.
15. Perform the backward solve for the interior nodes.
16. *EndDo*

As in the ILU(0) factorization, the interior nodes do not depend on the nodes from the external processors and can be computed in parallel in lines 3 and 15. In the forward solve, the solution of the interior nodes is followed by an exchange of data and the solution on the interface. The backward solve works in reverse in that the boundary nodes are first computed, then they are sent to adjacent processors. Finally, interior nodes are updated.

OTHER TECHNIQUES

12.7

This section gives a brief account of other parallel preconditioning techniques which are sometimes used. The next chapter also examines another important class of methods, which were briefly mentioned before, namely, the class of Domain Decomposition methods.

12.7.1 APPROXIMATE INVERSES

Another class of preconditioners that require only matrix-by-vector products, is the class of approximate inverse preconditioners. Discussed in Chapter 10, these can be used in many different ways. Besides being simple to implement, both their preprocessing phase and iteration phase allow a large degree of parallelism. Their disadvantage is similar to polynomial preconditioners, namely, the number of steps required for convergence may be large, possibly substantially larger than with the standard techniques. On the positive side, they are fairly robust techniques which can work well where standard methods may fail.

12.7.2 ELEMENT-BY-ELEMENT TECHNIQUES

A somewhat specialized set of techniques is the class of Element-By-Element (EBE) preconditioners which are geared toward finite element problems and are motivated by the desire to avoid assembling finite element matrices. Many finite element codes keep the data related to the linear system in unassembled form. The element matrices associated with each element are stored and never added together. This is convenient when using direct methods since there are techniques, known as frontal methods, that allow Gaussian elimination to be performed by using a few elements at a time.

It was seen in Chapter 2 that the global stiffness matrix A is the sum of matrices $A^{[e]}$ associated with each element, i.e.,

$$A = \sum_{e=1}^{Nel} A^{[e]}.$$

Here, the matrix $A^{[e]}$ is an $n \times n$ matrix defined as

$$A^{[e]} = P_e A_{K_e} P_e^T$$

in which A_{K_e} is the element matrix and P_e is a Boolean connectivity matrix which maps the coordinates of the small A_{K_e} matrix into those of the full matrix A . Chapter 2 showed how matrix-by-vector products can be performed in unassembled form. To perform this product in parallel, note that the only potential obstacle to performing the matrix-by-vector product in parallel, i.e., across all elements, is in the last phase, i.e., when the contributions are summed to the resulting vector y . In order to add the contributions $A^{[e]}x$ in parallel, group elements that do not have nodes in common. Referring to Equation (2.35), the contributions

$$y_e = A_{K_e} (P_e^T x)$$

can all be computed in parallel and do not depend on one another. The operations

$$y := y + P_e y_e$$

can be processed in parallel for any group of elements that do not share any vertices. This grouping can be found by performing a multicoloring of the elements. Any two elements which have a node in common receive a different color. Using this idea, good performance can be achieved on vector computers.

EBE preconditioners are based on similar principles and many different variants have been developed. They are defined by first normalizing each of the element matrices. In the sequel, assume that A is a Symmetric Positive Definite matrix. Typically, a diagonal, or block diagonal, scaling is first applied to A to obtain a scaled matrix \tilde{A} ,

$$\tilde{A} = D^{-1/2} A D^{-1/2}. \quad (12.24)$$

This results in each matrix $A^{[e]}$ and element matrix A_{K_e} being transformed similarly:

$$\begin{aligned} \tilde{A}^{[e]} &= D^{-1/2} A^{[e]} D^{-1/2} \\ &= D^{-1/2} P_e A_{K_e} D^{-1/2} \\ &= P_e (P_e^T D^{-1/2} P_e) A^{[e]} (P_e D^{-1/2} P_e^T) \\ &\equiv P_e \tilde{A}_{K_e} P_e^T. \end{aligned}$$

The second step in defining an EBE preconditioner is to *regularize* each of these transformed matrices. Indeed, each of the matrices $A^{[e]}$ is of rank p_e at most, where p_e is the size of the element matrix A_{K_e} , i.e., the number of nodes which constitute the e -th element. In the so-called *Winget regularization*, the diagonal of each $A^{[e]}$ is forced to be the identity matrix. In other words, the regularized matrix is defined as

$$\bar{A}^{[e]} = I + \tilde{A}^{[e]} - \text{diag}(\tilde{A}^{[e]}). \quad (12.25)$$

These matrices are positive definite; see Exercise 8.

The third and final step in defining an EBE preconditioner is to choose the factorization itself. In the EBE Cholesky factorization, the Cholesky (or Crout) factorization of each regularized matrix $\bar{A}^{[e]}$ is performed,

$$\bar{A}^{[e]} = L_e D_e L_e^T. \quad (12.26)$$

The preconditioner from it is defined as

$$M = \prod_{e=1}^{nel} L_e \times \prod_{e=1}^{nel} D_e \times \prod_{e=nel}^1 L_e^T. \quad (12.27)$$

Note that to ensure symmetry, the last product is in reverse order of the first one. The factorization (12.26) consists of a factorization of the small $p_e \times p_e$ matrix \bar{A}_{K_e} . Performing the preconditioning operations will therefore consist of a sequence of small $p_e \times p_e$ backward or forward solves. The gather and scatter matrices P_e defined in Chapter 2 must also be applied for each element. These solves are applied to the right-hand side in sequence. In addition, the same multicoloring idea as for the matrix-by-vector product can be exploited to perform these sweeps in parallel.

One of the drawbacks of the EBE Cholesky preconditioner is that an additional set of element matrices must be stored. That is because the factorizations (12.26) must be stored for each element. In EBE/SSOR, this is avoided. Instead of factoring each $\bar{A}^{[e]}$, the usual splitting of each $\bar{A}^{[e]}$ is exploited. Assuming the Winget regularization, we have

$$\bar{A}^{[e]} = I - E_e - E_e^T \quad (12.28)$$

in which $-E_e$ is the strict-lower part of $\bar{A}^{[e]}$. By analogy with the SSOR preconditioner,

the EBE-SSOR preconditioner is defined by

$$M = \prod_{e=1}^{nel} (I - \omega E_e) \times \prod_{e=1}^{nel} D_e \times \prod_{e=nel}^1 (I - \omega E_e^T). \quad (12.29)$$

12.7.3 PARALLEL ROW PROJECTION PRECONDITIONERS

One of the attractions of row-projection methods seen in Chapter 8 is their high degree of parallelism. In Cimmino's method, the scalars δ_i as well as the new residual vector can be computed in parallel. In the Gauss-Seidel-NE (respectively Gauss-Seidel-NR), it is also possible to group the unknowns in such a way that any pair of rows (respectively columns) have disjoint nonzero patterns. Updates of components in the same group can then be performed in parallel. This approach essentially requires finding a multicolor ordering for the matrix $B = AA^T$ (respectively $B = A^T A$).

It is necessary to first identify a partition of the set $\{1, 2, \dots, N\}$ into subsets $\mathcal{S}_1, \dots, \mathcal{S}_k$ such that the rows (respectively columns) whose indices belong to the same set \mathcal{S}_i are *structurally* orthogonal to each other, i.e., have no nonzero elements in the same column locations. When implementing a block SOR scheme where the blocking is identical with that defined by the partition, all of the unknowns belonging to the same set \mathcal{S}_j can be updated in parallel. To be more specific, the rows are reordered by scanning those in \mathcal{S}_1 followed by those in \mathcal{S}_2 , etc.. Denote by A_i the matrix consisting of the rows belonging to the i -th block. We assume that all rows of the same set are orthogonal to each other and that they have been normalized so that their 2-norm is unity. Then a block Gauss-Seidel sweep, which generalizes Algorithm 8.1, follows.

ALGORITHM 12.8: Forward Block NE-Gauss-Seidel Sweep

1. Select an initial x_0 .
 2. For $i = 1, 2, \dots, k$ Do:
 3. $d_i = b_i - A_i x$
 4. $x := x + A_i^T d_i$
 5. EndDo
-

Here, x_i and b_i are subvectors corresponding to the blocking and d_i is a vector of length the size of the block, which replaces the scalar δ_i of Algorithm 8.1. There is parallelism in each of the steps 3 and 4.

The question that arises is how to find good partitions \mathcal{S}_i . In simple cases, such as block-tridiagonal matrices, this can easily be done; see Exercise 7. For general sparse matrices, a multicoloring algorithm on the graph of AA^T (respectively $A^T A$) can be employed. However, these matrices are never stored explicitly. Their rows can be generated, used, and then discarded.

EXERCISES

1. Let A be a Symmetric Positive Definite matrix and consider $N = I - D^{-1}A$ where D is a block diagonal of A .
 - a. Show that D is a Symmetric Positive Definite matrix. Denote by $(\cdot, \cdot)_D$ the associated inner product.
 - b. Show that N is self-adjoint with respect to $(\cdot, \cdot)_D$.
 - c. Show that N^k is self-adjoint with respect to $(\cdot, \cdot)_D$ for any integer k .
 - d. Show that the Neumann series expansion preconditioner defined by the right-hand side of (12.3) leads to a preconditioned matrix that is self-adjoint with respect to the D -inner product.
 - e. Describe an implementation of the preconditioned CG algorithm using this preconditioner.
2. The development of the Chebyshev iteration algorithm seen in Section 12.3.2 can be exploited to derive yet another formulation of the conjugate algorithm from the Lanczos algorithm. Observe that the recurrence relation (12.8) is not restricted to scaled Chebyshev polynomials.
 - a. The scaled Lanczos polynomials, i.e., the polynomials $p_k(t)/p_k(0)$, in which $p_k(t)$ is the polynomial such that $v_{k+1} = p_k(A)v_1$ in the Lanczos algorithm, satisfy a relation of the form (12.8). What are the coefficients ρ_k and δ in this case?
 - b. Proceed in the same manner as in Section 12.3.2 to derive a version of the Conjugate Gradient algorithm.
3. Show that ρ_k as defined by (12.7) has a limit ρ . What is this limit? Assume that Algorithm 12.1 is to be executed with the ρ_k 's all replaced by this limit ρ . Will the method converge? What is the asymptotic rate of convergence of this modified method?
4. Derive the least-squares polynomials for $\alpha = -\frac{1}{2}$, $\beta = \frac{1}{2}$ for the interval $[0, 1]$ for $k = 1, 2, 3, 4$. Check that these results agree with those of the table shown at the end of Section 12.3.3.
5. Consider the mesh shown below. Assume that the objective is to solve the Poisson equation with Dirichlet boundary conditions.

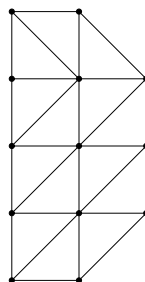

- a. Consider the resulting matrix obtained (before boundary conditions are applied) from ordering the nodes from bottom up, and left to right (thus, the bottom left vertex is labeled 1 and the top right vertex is labeled 13). What is the bandwidth of the linear system? How many memory locations would be needed to store the matrix in Skyline format? (Assume that the matrix is nonsymmetric so both upper and lower triangular parts must be stored).

- b.* Is it possible to find a 2-color ordering of the mesh points? If so, show the ordering, or otherwise prove that it is not possible.
- c.* Find an independent set of size 5. Show the pattern of the matrix associated with this independent set ordering.
- d.* Find a multicolor ordering of the mesh by using the greedy multicolor algorithm. Can you find a better coloring (i.e., a coloring with fewer colors)? If so, show the coloring [use letters to represent each color].
6. A linear system $Ax = b$ where A is a 5-point matrix, is reordered using red-black ordering as
- $$\begin{pmatrix} D_1 & F \\ E & D_2 \end{pmatrix} \begin{pmatrix} x \\ y \end{pmatrix} = \begin{pmatrix} f \\ g \end{pmatrix}.$$
- a.* Write the block Gauss-Seidel iteration associated with the above partitioned system (where the blocking in block Gauss-Seidel is the same as the above blocking).
- b.* Express the y iterates, independently of the x iterates, i.e., find an iteration which involves only y -iterates. What type of iteration is the resulting scheme?
7. Consider a tridiagonal matrix $T = \text{tridiag}(a_i, b_i, c_i)$. Find a grouping of the rows such that rows in each group are *structurally* orthogonal, i.e., orthogonal regardless of the values of the entry. Find a set of three groups at most. How can this be generalized to block tridiagonal matrices such as those arising from 2-D and 3-D centered difference matrices?
8. Why are the Winget regularized matrices $\tilde{A}^{[e]}$ defined by (12.25) positive definite when the matrix \tilde{A} is obtained from A by a *diagonal* scaling from A ?

NOTES AND REFERENCES. As vector processing appeared in the middle to late 1970s, a number of efforts were made to change algorithms, or implementations of standard methods, to exploit the new architectures. One of the first ideas in this context was to perform matrix-by-vector products by diagonals [133]. Matrix-by-vector products using this format can yield excellent performance. Hence, came the idea of using polynomial preconditioning. Polynomial preconditioning was exploited independently of supercomputing, as early as 1952 in a paper by Lanczos [141], and later for eigenvalue problems by Stiefel who employed least-squares polynomials [204], and Rutishauser [171] who combined the QD algorithm with Chebyshev acceleration. Dubois et al. [75] suggested using polynomial preconditioning, specifically, the Neumann series expansion, for solving Symmetric Positive Definite linear systems on vector computers. Johnson et al. [129] later extended the idea by exploiting Chebyshev polynomials, and other orthogonal polynomials. It was observed in [129] that least-squares polynomials tend to perform better than those based on the uniform norm, in that they lead to a better overall clustering of the spectrum. Moreover, as was already observed by Rutishauser [171], in the symmetric case there is no need for accurate eigenvalue estimates: It suffices to use the simple bounds that are provided by Gershgorin's theorem. In [175] it was also observed that in some cases the least-squares polynomial approach which requires less information than the Chebyshev approach tends to perform better.

The use of least-squares polynomials over polygons was first advocated by Smolarski and Saylor [200] and later by Saad [176]. The application to the indefinite case was examined in detail in [174]. Still in the context of using polygons instead of ellipses, yet another attractive possibility proposed by Fischer and Reichel [91] avoids the problem of best approximation altogether. The polygon can be conformally transformed into a circle and the theory of Faber polynomials yields a simple way of deriving good polynomials from exploiting specific points on the circle.

Although only approaches based on the formulation (12.5) and (12.11) have been discussed, there are other lesser known possibilities based on minimizing $\|1/\lambda - s(\lambda)\|_\infty$. There has been

very little work on polynomial preconditioning or Krylov subspace methods for highly non-normal matrices; see, however, the recent analysis in [207]. Another important point is that polynomial preconditioning can be combined with a subsidiary relaxation-type preconditioning such as SSOR [2, 153]. Finally, polynomial preconditionings can be useful in some special situations such as that of complex linear systems arising from the Helmholtz equation [93].

Multicoloring has been known for a long time in the numerical analysis literature and was used in particular for understanding the theory of relaxation techniques [232, 213] as well as for deriving efficient alternative formulations of some relaxation algorithms [213, 110]. More recently, it became an essential ingredient in parallelizing iterative algorithms, see for example [4, 2, 82, 155, 154, 164]. It is also commonly used in a slightly different form — coloring elements as opposed to nodes — in finite elements techniques [23, 217]. In [182] and [69], it was observed that k -step SOR preconditioning was very competitive relative to the standard ILU preconditioners. Combined with multicolor ordering, multiple-step SOR can perform quite well on supercomputers. Multicoloring is especially useful in Element-By-Element techniques when forming the residual, i.e., when multiplying an unassembled matrix by a vector [123, 88, 194]. The contributions of the elements of the same color can all be evaluated and applied simultaneously to the resulting vector. In addition to the parallelization aspects, reduced systems can sometimes be much better conditioned than the original system, see [83].

Independent set orderings have been used mainly in the context of parallel direct solution techniques for sparse matrices [66, 144, 145] and multifrontal techniques [77] can be viewed as a particular case. The gist of all these techniques is that it is possible to reorder the system in groups of equations which can be solved simultaneously. A parallel direct solution sparse solver based on performing several successive levels of independent set orderings and reduction was suggested in [144] and in a more general form in [65]. ■

DOMAIN DECOMPOSITION METHODS

As multiprocessing technology is steadily gaining ground, new classes of numerical methods that can take better advantage of parallelism are emerging. Among these techniques, domain decomposition methods are undoubtedly the best known and perhaps the most promising for certain types of problems. These methods combine ideas from Partial Differential Equations, linear algebra, mathematical analysis, and techniques from graph theory. This chapter is devoted to “decomposition” methods, which are based on the general concepts of graph partitionings.

INTRODUCTION

13.1

Domain decomposition methods refer to a collection of techniques which revolve around the principle of divide-and-conquer. Such methods have been primarily developed for solving Partial Differential Equations over regions in two or three dimensions. However, similar principles have been exploited in other contexts of science and engineering. In fact, one of the earliest practical uses for domain decomposition approaches was in structural engineering, a discipline which is not dominated by Partial Differential Equations. Although this chapter considers these techniques from a purely linear algebra view-point, the basic concepts, as well as the terminology, are introduced from a model Partial Differential Equation.

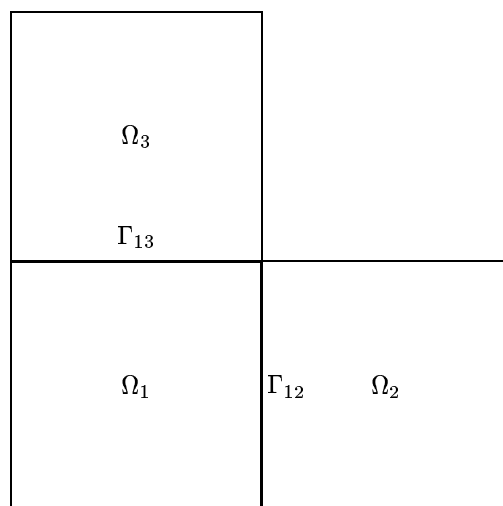

Figure 13.1 An L-shaped domain subdivided into three subdomains.

Consider the problem of solving the Laplace Equation on an L-shaped domain Ω partitioned as shown in Figure 13.1. Domain decomposition or substructuring methods attempt to solve the problem on the entire domain

$$\Omega = \bigcup_{i=1}^s \Omega_i,$$

from problem solutions on the subdomains Ω_i . There are several reasons why such techniques can be advantageous. In the case of the above picture, one obvious reason is that the subproblems are much simpler because of their rectangular geometry. For example, fast solvers can be used on each subdomain in this case. A second reason is that the physical problem can sometimes be split naturally into a small number of subregions where the modeling equations are different (e.g., Euler's equations on one region and Navier-Stokes in another). Substructuring can also be used to develop "out-of-core" solution techniques. As already mentioned, such techniques were often used in the past to analyze very large mechanical structures. The original structure is partitioned into s pieces, each of which is small enough to fit into memory. Then a form of block-Gaussian elimination is used to solve the global linear system from a sequence of solutions using s subsystems. More recent interest in domain decomposition techniques has been motivated by parallel processing.

13.1.1 NOTATION

In order to review the issues and techniques in use and to introduce some notation, assume that the following problem is to be solved:

$$\Delta u = f \text{ in } \Omega$$

$$u = u_\Gamma \text{ on } \Gamma = \partial\Omega.$$

Domain decomposition methods are all implicitly or explicitly based on different ways of handling the unknown at the interfaces. From the PDE point of view, if the value of the solution is known at the interfaces between the different regions, these values could be used in Dirichlet-type boundary conditions and we will obtain s uncoupled Poisson equations. We can then solve these equations to obtain the value of the solution at the interior points. If the whole domain is discretized by either finite elements or finite difference techniques, then this is easily translated into the resulting linear system.

Now some terminology and notation will be introduced for use throughout this chapter. Assume that the problem associated with domain shown in Figure 13.1 is discretized with centered differences. We can label the nodes by subdomain as shown in Figure 13.3. Note that the interface nodes are labeled last. As a result, the matrix associated with this problem will have the structure shown in Figure 13.4. For a general partitioning into s subdomains, the linear system associated with the problem has the following structure:

$$\begin{pmatrix} B_1 & & & E_1 \\ & B_2 & & E_2 \\ & & \ddots & \vdots \\ & & & B_s & E_s \\ F_1 & F_2 & \cdots & F_s & C \end{pmatrix} \begin{pmatrix} x_1 \\ x_2 \\ \vdots \\ x_s \\ y \end{pmatrix} = \begin{pmatrix} f_1 \\ f_2 \\ \vdots \\ f_s \\ g \end{pmatrix} \quad (13.1)$$

where each x_i represents the subvector of unknowns that are interior to subdomain Ω_i and y represents the vector of all interface unknowns. It is useful to express the above system in the simpler form,

$$A \begin{pmatrix} x \\ y \end{pmatrix} = \begin{pmatrix} f \\ g \end{pmatrix} \quad \text{with} \quad A = \begin{pmatrix} B & E \\ F & C \end{pmatrix}. \quad (13.2)$$

Thus, E represents the subdomain to interface coupling seen from the subdomains, while F represents the interface to subdomain coupling seen from the interface nodes.

13.1.2 TYPES OF PARTITIONINGS

When partitioning a problem, it is common to use graph representations. Since the sub-problems obtained from a given partitioning will eventually be mapped into distinct processors, there are some restrictions regarding the type of partitioning needed. For example, in Element-By-Element finite element techniques, it may be desirable to map elements into processors instead of vertices. In this case, the restriction means no element should be split between two subdomains, i.e., all information related to a given element is mapped to the same processor. These partitionings are termed element-based. A somewhat less restrictive class of partitionings are the edge-based partitionings, which do not allow edges to be split between two subdomains. These may be useful for finite volume techniques where computations are expressed in terms of fluxes across edges in two dimensions. Finally, vertex-based partitionings work by dividing the origin vertex set into subsets of vertices and have no restrictions on the edges, i.e., they allow edges or elements to straddle between subdomains. See Figure 13.2, (a), (b), and (c).

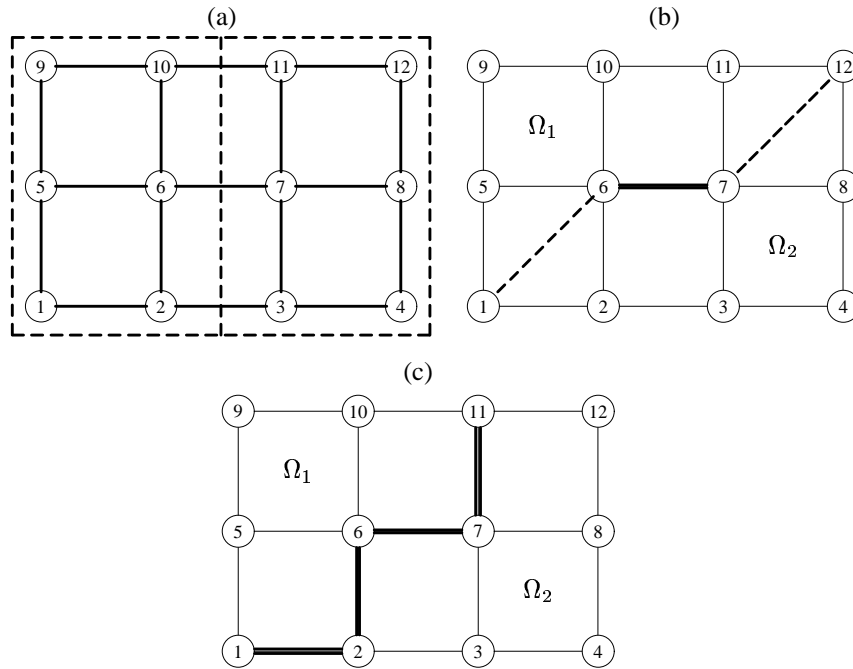

Figure 13.2 (a) Vertex-based, (b) edge-based, and (c) element-based partitioning of a 4×3 mesh into two subregions.

13.1.3 TYPES OF TECHNIQUES

The interface values can be obtained by employing a form of block-Gaussian elimination which may be too expensive for large problems. In some simple cases, using FFT's, it is possible to explicitly obtain the solution of the problem on the interfaces inexpensively.

Other methods alternate between the subdomains, solving a new problem each time, with boundary conditions updated from the most recent subdomain solutions. These methods are called *Schwarz Alternating Procedures*, after the Swiss mathematician who used the idea to prove the existence for a solution of the Dirichlet problem on irregular regions.

The subdomains may be allowed to *overlap*. This means that the Ω_i 's are such that

$$\Omega = \bigcup_{i=1,s} \Omega_i, \quad \Omega_i \cap \Omega_j \neq \phi.$$

For a discretized problem, it is typical to quantify the extent of overlapping by the number of mesh-lines that are common to the two subdomains. In the particular case of Figure 13.3, the overlap is of order one.

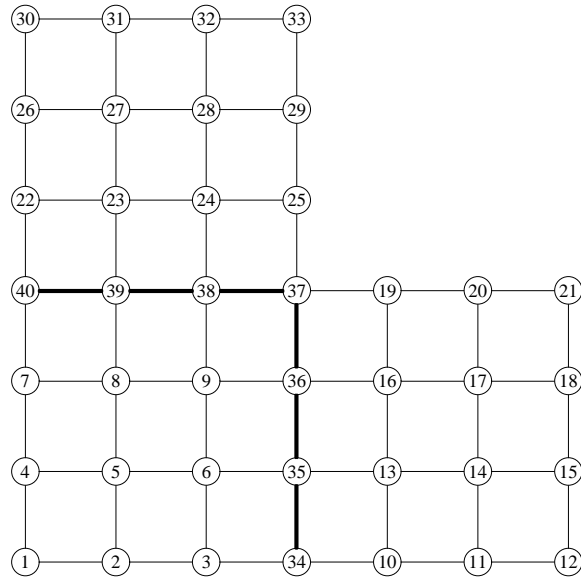

Figure 13.3 Discretization of problem shown in Figure 13.1.

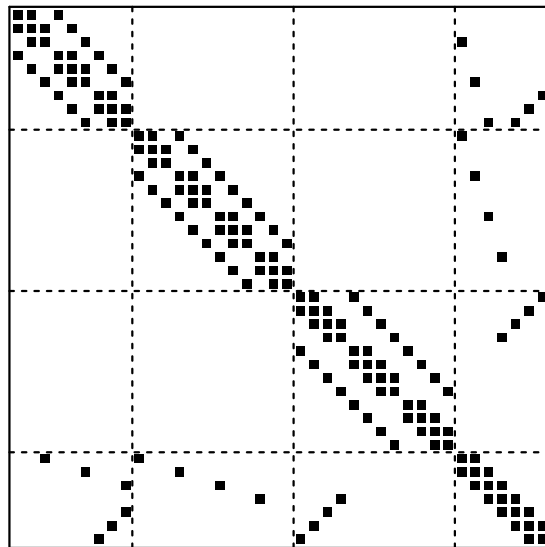

Figure 13.4 Matrix associated with the finite difference mesh of Figure 13.3.

The various domain decomposition techniques are distinguished by four features:

1. *Type of Partitioning*. For example, should partitioning occur along edges, or along

vertices, or by elements? Is the union of the subdomains equal to the original domain or a superset of it (fictitious domain methods)?

2. *Overlap.* Should sub-domains overlap or not, and by how much?
3. *Processing of interface values.* For example, is the Schur complement approach used? Should there be successive updates to the interface values?
4. *Subdomain solution.* Should the subdomain problems be solved exactly or approximately by an iterative method?

The methods to be discussed in this chapter will be classified in four distinct groups. First, direct methods and the substructuring approach are useful for introducing some definitions and for providing practical insight. Second, among the simplest and oldest techniques are the Schwarz Alternating Procedures. Then, there are methods based on preconditioning the Schur complement system. The last category groups all the methods based on solving the linear system with the matrix A , by using a preconditioning derived from Domain Decomposition concepts.

DIRECT SOLUTION AND THE SCHUR COMPLEMENT

13.2

One of the first divide-and-conquer ideas used in structural analysis exploited the partitioning (13.1) in a direct solution framework. This approach, which is covered in this section, introduces the Schur complement and explains some of its properties.

13.2.1 BLOCK GAUSSIAN ELIMINATION

Consider the linear system written in the form (13.2), in which B is assumed to be nonsingular. From the first equation the unknown x can be expressed as

$$x = B^{-1}(f - Ey). \quad (13.3)$$

Upon substituting this into the second equation, the following *reduced system* is obtained:

$$(C - FB^{-1}E)y = g - FB^{-1}f. \quad (13.4)$$

The matrix

$$S = C - FB^{-1}E \quad (13.5)$$

is called the *Schur complement* matrix associated with the y variable. If this matrix can be formed and the linear system (13.4) can be solved, all the interface variables y will become available. Once these variables are known, the remaining unknowns can be computed, via (13.3). Because of the particular structure of B , observe that any linear system solution with it decouples in s separate systems. The parallelism in this situation arises from this natural decoupling.

A solution method based on this approach involves four steps:

1. Obtain the right-hand side of the reduced system (13.4).
2. Form the Schur complement matrix (13.5).
3. Solve the reduced system (13.4).
4. Back-substitute using (13.3) to obtain the other unknowns.

One linear system solution with the matrix B can be saved by reformulating the algorithm in a more elegant form. Define

$$E' = B^{-1}E \quad \text{and} \quad f' = B^{-1}f.$$

The matrix E' and the vector f' are needed in steps (1) and (2). Then rewrite step (4) as

$$x = B^{-1}f - B^{-1}Ey = f' - E'y,$$

which gives the following algorithm.

ALGORITHM 13.1: Block-Gaussian Elimination

1. Solve $BE' = B$, and $Bf' = f$ for E' and f' , respectively
2. Compute $g' = g - Ff'$
3. Compute $S = C - FE'$
4. Solve $Sy = g'$
5. Compute $x = f' - E'y$.

In a practical implementation, all the B_i matrices are factored and then the systems $B_i E'_i = E_i$ and $B_i f'_i = f_i$ are solved. In general, many columns in E_i will be zero. These zero columns correspond to interfaces that are not adjacent to subdomain i . Therefore, any efficient code based on the above algorithm should start by identifying the nonzero columns.

13.2.2 PROPERTIES OF THE SCHUR COMPLEMENT

Now the connections between the Schur complement and standard Gaussian elimination will be explored and a few simple properties will be established. Start with the block-LU factorization of A ,

$$\begin{pmatrix} B & E \\ F & C \end{pmatrix} = \begin{pmatrix} I & O \\ FB^{-1} & I \end{pmatrix} \begin{pmatrix} B & E \\ O & S \end{pmatrix} \tag{13.6}$$

which is readily verified. The Schur complement can therefore be regarded as the (2,2) block in the U part of the block-LU factorization of A . From the above relation, note that if A is nonsingular, then so is S . Taking the inverse of A with the help of the above equality yields

$$\begin{aligned} \begin{pmatrix} B & E \\ F & C \end{pmatrix}^{-1} &= \begin{pmatrix} B^{-1} & -B^{-1}ES^{-1} \\ O & S^{-1} \end{pmatrix} \begin{pmatrix} I & O \\ -FB^{-1} & I \end{pmatrix} \\ &= \begin{pmatrix} B^{-1} + B^{-1}ES^{-1}FB^{-1} & -B^{-1}ES^{-1} \\ -S^{-1}FB^{-1} & S^{-1} \end{pmatrix}. \end{aligned} \tag{13.7}$$

Observe that S^{-1} is the (2,2) block in the block-inverse of A . In particular, if the original matrix A is Symmetric Positive Definite, then so is A^{-1} . As a result, S is also Symmetric Positive Definite in this case.

Although simple to prove, the above properties are nonetheless important. They are summarized in the following proposition.

PROPOSITION 13.1 *Let A be a nonsingular matrix partitioned as in (13.2) and such that the submatrix B is nonsingular and let R_y be the restriction operator onto the interface variables, i.e., the linear operator defined by*

$$R_y \begin{pmatrix} x \\ y \end{pmatrix} = y.$$

Then the following properties are true.

1. *The Schur complement matrix S is nonsingular.*
2. *If A is SPD, then so is S .*
3. *For any y , $S^{-1}y = R_y A^{-1} \begin{pmatrix} 0 \\ y \end{pmatrix}$.*

The first property indicates that a method that uses the above block Gaussian elimination algorithm is feasible since S is nonsingular. A consequence of the second property is that when A is positive definite, an algorithm such as the Conjugate Gradient algorithm can be used to solve the reduced system (13.4). Finally, the third property establishes a relation which may allow preconditioners for S to be defined based on solution techniques with the matrix A .

13.2.3 SCHUR COMPLEMENT FOR VERTEX-BASED PARTITIONINGS

The partitioning used in Figure 13.3 is edge-based, meaning that a given edge in the graph does not straddle two subdomains. If two vertices are coupled, then they must belong to the same subdomain. From the graph theory point of view, this is perhaps less common than vertex-based partitionings in which a vertex is not shared by two partitions (except when domains overlap). A vertex-based partitioning is illustrated in Figure 13.5.

We will call interface edges all edges that link vertices that do not belong to the same subdomain. In the case of overlapping, this needs clarification. An overlapping edge or vertex belongs to the same subdomain. Interface edges are only those that link a vertex to another vertex which is not in the same subdomain already, whether in the overlapping portion or elsewhere. Interface vertices are those vertices in a given subdomain that are adjacent to an interface edge. For the example of the figure, the interface vertices for subdomain one (bottom, left subsquare) are the vertices labeled 10 to 16. The matrix shown at the bottom of Figure 13.5 differs from the one of Figure 13.4, because here the interface nodes are not relabeled the last in the global labeling as was done in Figure 13.3. Instead, the interface nodes are labeled as the last nodes in each subdomain. The number of interface nodes is about twice that of the edge-based partitioning.

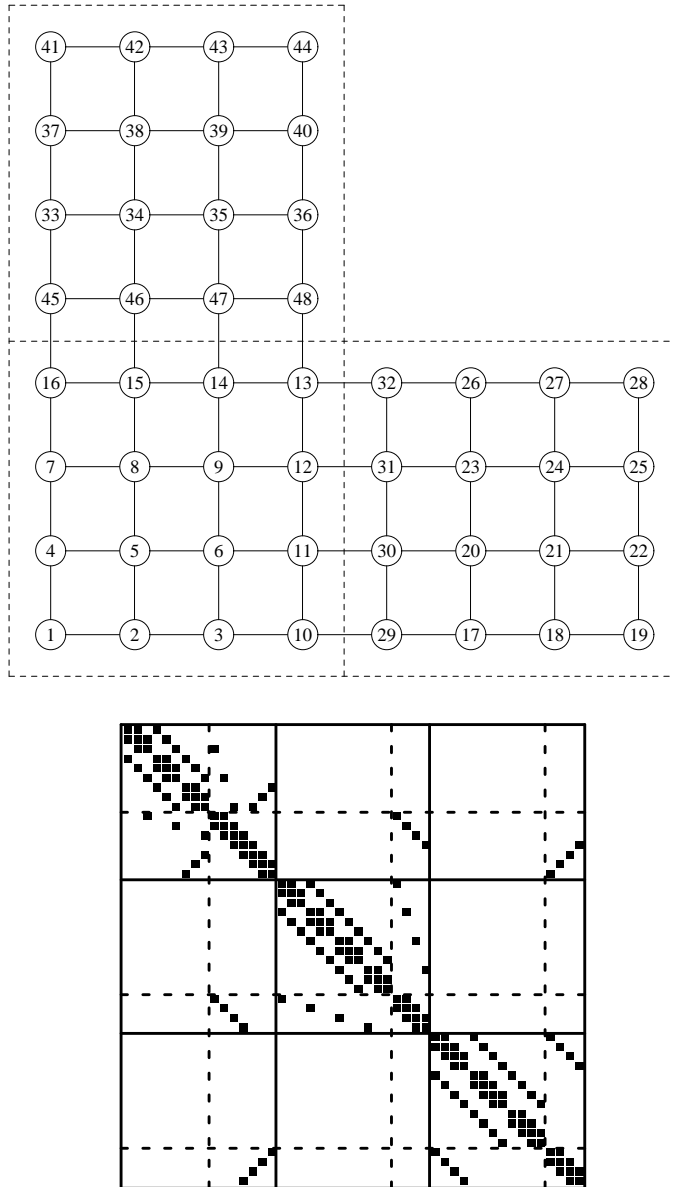

Figure 13.5 Discretization of problem shown in Figure 13.1 and associated matrix.

Consider the Schur complement system obtained with this new labeling. It can be written similar to the edge-based case using a reordering in which all interface variables are listed last. The matrix associated with the domain partitioning of the variables will have

a natural s -block structure where s is the number of subdomains. For example, when $s = 3$ (as is the case in the above illustration), the matrix has the block structure defined by the solid lines in the figure, i.e.,

$$A = \begin{pmatrix} A_1 & A_{12} & A_{13} \\ A_{21} & A_2 & A_{23} \\ A_{31} & A_{32} & A_3 \end{pmatrix}. \quad (13.8)$$

In each subdomain, the variables are of the form

$$z_i = \begin{pmatrix} x_i \\ y_i \end{pmatrix},$$

where x_i denotes interior nodes while y_i denotes the interface nodes associated with subdomain i . Each matrix A_i will be called the local matrix. The structure of A_i is as follows:

$$A_i = \begin{pmatrix} B_i & E_i \\ F_i & C_i \end{pmatrix} \quad (13.9)$$

in which, as before, B_i represents the matrix associated with the internal nodes of subdomain i and E_i and F_i represent the couplings to/from external nodes. The matrix C_i is the local part of the interface matrix C defined before, and represents the coupling between local interface points. A careful look at the matrix in Figure 13.5 reveals an additional structure for the blocks A_{ij} $j \neq i$. Each of these blocks contains a zero sub-block in the part that acts on the variable x_j . This is expected since x_i and x_j are not coupled. Therefore,

$$A_{ij} = \begin{pmatrix} 0 \\ E_{ij} \end{pmatrix}. \quad (13.10)$$

In addition, most of the E_{ij} matrices are zero since only those indices j of the subdomains that have couplings with subdomain i will yield a nonzero E_{ij} .

Now write the part of the linear system that is local to subdomain i , as

$$\begin{aligned} B_i x_i + E_i y_i &= f_i \\ F_i x_i + C_i y_i + \sum_{j \in N_i} E_{ij} y_j &= g_i \end{aligned} \quad (13.11)$$

The term $E_{ij} y_j$ is the contribution to the equation from the neighboring subdomain number j , and N_i is the set of subdomains that are adjacent to subdomain i . Assuming that B_i is nonsingular, the variable x_i can be eliminated from this system by extracting from the first equation $x_i = B_i^{-1}(f_i - E_i y_i)$ which yields, upon substitution in the second equation,

$$S_i y_i + \sum_{j \in N_i} E_{ij} y_j = g_i - F_i B_i^{-1} f_i, \quad i = 1, \dots, s \quad (13.12)$$

in which S_i is the “local” Schur complement

$$S_i = C_i - F_i B_i^{-1} E_i. \quad (13.13)$$

When written for all subdomains i , the equations (13.12) yield a system of equations which involves only the interface points y_j , $j = 1, 2, \dots, s$ and which has a natural block structure

associated with these vector variables

$$S = \begin{pmatrix} S_1 & E_{12} & E_{13} & \cdots & E_{1s} \\ E_{21} & S_2 & E_{23} & \cdots & E_{2s} \\ \vdots & & \ddots & & \vdots \\ \vdots & & & \ddots & \vdots \\ E_{s1} & E_{s2} & E_{s3} & \cdots & S_s \end{pmatrix}. \quad (13.14)$$

The diagonal blocks in this system, namely, the matrices S_i , are dense in general, but the offdiagonal blocks E_{ij} are sparse and most of them are zero. Specifically, $E_{ij} \neq 0$ only if subdomains i and j have at least one equation that couples them.

A structure of the global Schur complement S has been unraveled which has the following important implication: *For vertex-based partitionings, the Schur complement matrix can be assembled from local Schur complement matrices (the S_i 's) and interface-to-interface information (the E_{ij} 's).* The term "assembled" was used on purpose because a similar idea will be exploited for finite element partitionings.

13.2.4 SCHUR COMPLEMENT FOR FINITE-ELEMENT PARTITIONINGS

In finite-element partitionings, the original discrete set Ω is subdivided into s subsets Ω_i , each consisting of a distinct set of elements. Given a finite element discretization of the domain Ω , a finite dimensional space V_h of functions over Ω is defined, e.g., functions that are piecewise linear and continuous on Ω , and that vanish on the boundary Γ of Ω . Consider now the Dirichlet problem on Ω and recall that its weak formulation on the finite element discretization can be stated as follows (see Section 2.3):

$$\text{Find } u \in V_h \text{ such that } a(u, v) = (f, v), \quad \forall v \in V_h,$$

where the bilinear form $a(\cdot, \cdot)$ is defined by

$$a(u, v) = \int_{\Omega} \nabla u \cdot \nabla v \, dx = \int_{\Omega} \left(\frac{\partial u}{\partial x_1} \frac{\partial v}{\partial x_1} + \frac{\partial u}{\partial x_2} \frac{\partial v}{\partial x_2} \right) dx.$$

It is interesting to observe that since the set of the elements of the different Ω_i 's are disjoint, $a(\cdot, \cdot)$ can be decomposed as

$$a(u, v) = \sum_{i=1}^s a_i(u, v),$$

where

$$a_i(u, v) = \int_{\Omega_i} \nabla u \cdot \nabla v \, dx.$$

In fact, this is a generalization of the technique used to assemble the stiffness matrix from element matrices, which corresponds to the extreme case where each Ω_i consists of exactly one element.

If the unknowns are ordered again by subdomains and the interface nodes are placed

last as was done in Section 13.1, immediately the system shows the same structure,

$$\begin{pmatrix} B_1 & & & E_1 \\ & B_2 & & E_2 \\ & & \ddots & \vdots \\ & & & B_s & E_s \\ F_1 & F_2 & \cdots & F_s & C \end{pmatrix} \begin{pmatrix} x_1 \\ x_2 \\ \vdots \\ x_s \\ y \end{pmatrix} = \begin{pmatrix} f_1 \\ f_2 \\ \vdots \\ f_s \\ g \end{pmatrix} \quad (13.15)$$

where each B_i represents the coupling between interior nodes and E_i and F_i represent the coupling between the interface nodes and the nodes interior to Ω_i . Note that each of these matrices has been assembled from element matrices and can therefore be obtained from contributions over all subdomain Ω_j that contain any node of Ω_i .

In particular, assume that the assembly is considered only with respect to Ω_i . Then the assembled matrix will have the structure

$$A_i = \begin{pmatrix} B_i & E_i \\ F_i & C_i \end{pmatrix},$$

where C_i contains only contributions from local elements, i.e., elements that are in Ω_i . Clearly, C is the sum of the C_i 's,

$$C = \sum_{i=1}^s C_i.$$

The Schur complement associated with the interface variables is such that

$$\begin{aligned} S &= C - FB^{-1}E \\ &= C - \sum_{i=1}^s F_i B_i^{-1} E_i \\ &= \sum_{i=1}^s C_i - \sum_{i=1}^s F_i B_i^{-1} E_i \\ &= \sum_{i=1}^s [C_i - F_i B_i^{-1} E_i]. \end{aligned}$$

Therefore, if S_i denotes the *local* Schur complement

$$S_i = C_i - F_i B_i^{-1} E_i,$$

then the above proves that,

$$S = \sum_{i=1}^s S_i, \quad (13.16)$$

showing again that the Schur complement can be obtained easily from smaller Schur complement matrices.

Another important observation is that the stiffness matrix A_k , defined above by restricting the assembly to Ω_k , solves a Neumann-Dirichlet problem on Ω_k . Indeed, consider the problem

$$\begin{pmatrix} B_k & E_k \\ F_k & C_k \end{pmatrix} \begin{pmatrix} x_k \\ y_k \end{pmatrix} = \begin{pmatrix} b_k \\ g_k \end{pmatrix}. \quad (13.17)$$

The elements of the submatrix C_k are the terms $a_k(\phi_i, \phi_j)$ where ϕ_i, ϕ_j are the basis functions associated with nodes belonging to the interface Γ_k . As was stated above, the matrix C is the sum of these submatrices. Consider the problem of solving the Poisson equation on Ω_k with boundary conditions defined as follows: On Γ_{k0} , the part of the boundary which belongs to Γ_k , use the original boundary conditions; on the interfaces Γ_{kj} with other subdomains, use a Neumann boundary condition. According to Equation (2.36) seen in Section 2.3, the j -th equation will be of the form,

$$\int_{\Omega_k} \nabla u \cdot \nabla \phi_j \, dx = \int_{\Omega_k} f \phi_j \, dx + \int_{\Gamma_k} \phi_j \frac{\partial u}{\partial \bar{n}} \, ds. \quad (13.18)$$

This gives rise to a system of the form (13.17) in which the g_k part of the right-hand side incorporates the Neumann data related to the second integral on the right-hand side of (13.18).

It is interesting to note that if a problem were to be solved with all-Dirichlet conditions, i.e., if the Neumann conditions at the interfaces were replaced by Dirichlet conditions, the resulting matrix problem would be of the form,

$$\begin{pmatrix} B_k & E_k \\ 0 & I \end{pmatrix} \begin{pmatrix} x_k \\ y_k \end{pmatrix} = \begin{pmatrix} b_k \\ g_k \end{pmatrix} \quad (13.19)$$

where g_k represents precisely the Dirichlet data. Indeed, according to what was seen in Section 2.3, Dirichlet conditions are handled simply by replacing equations associated with boundary points by identity equations.

SCHWARZ ALTERNATING PROCEDURES

13.3

The original alternating procedure described by Schwarz in 1870 consisted of three parts: alternating between two overlapping domains, solving the Dirichlet problem on one domain at each iteration, and taking boundary conditions based on the most recent solution obtained from the other domain. This procedure is called the Multiplicative Schwarz procedure. In matrix terms, this is very reminiscent of the block Gauss-Seidel iteration with overlap defined with the help of projectors, as seen in Chapter 5. The analogue of the block-Jacobi procedure is known as the Additive Schwarz procedure.

13.3.1 MULTIPLICATIVE SCHWARZ PROCEDURE

In the following, assume that each pair of neighboring subdomains has a nonvoid overlapping region. The boundary of subdomain Ω_i that is included in subdomain j is denoted by $\Gamma_{i,j}$.

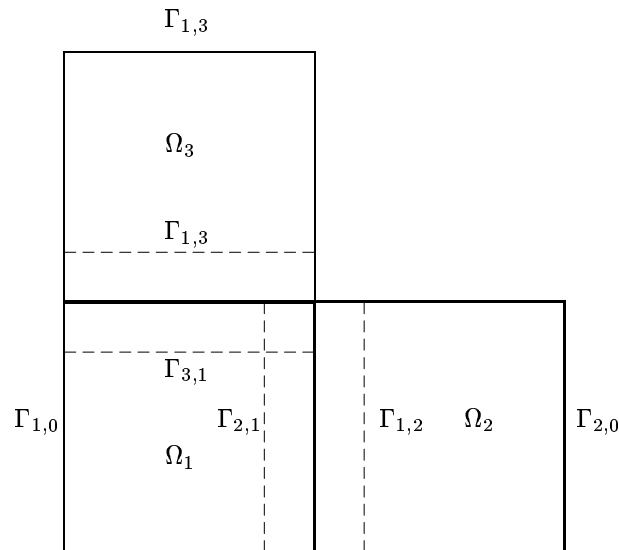

Figure 13.6 An L-shaped domain subdivided into three overlapping subdomains.

This is illustrated in Figure 13.6 for the L-shaped domain example. Each subdomain extends beyond its initial boundary into neighboring subdomains. Call Γ_i the boundary of Ω_i consisting of its original boundary (which is denoted by $\Gamma_{i,0}$) and the $\Gamma_{i,j}$'s, and denote by u_{ji} the restriction of the solution u to the boundary Γ_{ji} . Then the Schwarz Alternating Procedure can be described as follows.

ALGORITHM 13.2: SAP

1. Choose an initial guess u to the solution
2. Until convergence Do:
 3. For $i = 1, \dots, s$ Do:
 4. Solve $\Delta u = f$ in Ω_i with $u = u_{ij}$ in Γ_{ij}
 5. Update u values on Γ_{ji} , $\forall j$
 6. EndDo
7. EndDo

The algorithm sweeps through the s subdomains and solves the original equation in each of them by using boundary conditions that are updated from the most recent values of u . Since each of the subproblems is likely to be solved by some iterative method, we can take advantage of a good initial guess. It is natural to take as initial guess for a given subproblem the most recent approximation. Going back to the expression (13.11) of the local problems, observe that each of the solutions in line 4 of the algorithm will be translated into an update of the form

$$u_i := u_i + \delta_i,$$

where the correction δ_i solves the system

$$A_i \delta_i = r_i.$$

Here, r_i is the local part of the most recent global residual vector $b - Ax$, and the above system represents the system associated with the problem in line 4 of the algorithm when a nonzero initial guess is used in some iterative procedure. The matrix A_i has the block structure (13.9). Writing

$$u_i = \begin{pmatrix} x_i \\ y_i \end{pmatrix}, \quad \delta_i = \begin{pmatrix} \delta_{x,i} \\ \delta_{y,i} \end{pmatrix}, \quad r_i = \begin{pmatrix} r_{x,i} \\ r_{y,i} \end{pmatrix},$$

the correction to the current solution step in the algorithm leads to

$$\begin{pmatrix} x_i \\ y_i \end{pmatrix} := \begin{pmatrix} x_i \\ y_i \end{pmatrix} + \begin{pmatrix} B_i & E_i \\ F_i & C_i \end{pmatrix}^{-1} \begin{pmatrix} r_{x,i} \\ r_{y,i} \end{pmatrix}. \quad (13.20)$$

After this step is taken, normally a residual vector r would have to be computed again to get the components associated with domain $i + 1$ and to proceed with a similar step for the next subdomain. However, only those residual components that have been affected by the change of the solution need to be updated. Specifically, employing the same notation used in equation (13.11), we can simply update the residual $r_{y,j}$ for each subdomain j for which $i \in N_j$ as

$$r_{y,j} := r_{y,j} - E_{ji} \delta_{y,i}.$$

This amounts implicitly to performing Step 5 of the above algorithm. Note that since the matrix pattern is assumed to be symmetric, then the set of all indices j such that $i \in N_j$, i.e., $N_i^* = \{j \mid i \in N_j\}$, is identical to N_i . Now the loop starting in line 3 of Algorithm 13.2 and called *domain sweep* can be restated as follows.

ALGORITHM 13.3: Multiplicative Schwarz Sweep – Matrix Form

1. For $i = 1, \dots, s$ Do:
 2. Solve $A_i \delta_i = r_i$
 3. Compute $x_i := x_i + \delta_{x,i}$, $y_i := y_i + \delta_{y,i}$, and set $r_i := 0$
 4. For each $j \in N_i$ Compute $r_{y,j} := r_{y,j} - E_{ji} \delta_{y,i}$
 5. EndDo
-

Considering only the y iterates, the above iteration would resemble a form of Gauss-Seidel procedure on the Schur complement matrix (13.14). In fact, it is mathematically equivalent, provided a consistent initial guess is taken. This is stated in the next result established by Chan and Goovaerts [48]:

THEOREM 13.1 Let the guess $\begin{pmatrix} x_i^{(0)} \\ y_i^{(0)} \end{pmatrix}$ for the Schwarz procedure in each subdomain be chosen such that

$$x_i^{(0)} = B_i^{-1} [f_i - E_i y_i^{(0)}]. \quad (13.21)$$

Then the y iterates produced by the Algorithm 13.3 are identical to those of a Gauss-Seidel sweep applied to the Schur complement system (13.12).

Proof. We start by showing that with the choice (13.21), the y components of the initial residuals produced by the algorithm are identical to those of the Schur complement system (13.12). Refer to Section 13.2.3 and the relation (13.10) which defines the E_{ij} 's from the block structure (13.8) of the global matrix. Observe that $A_{ij}u_j = E_{ij}y_j$ and note from (13.11) that for the global system the y components of the initial residual vectors are

$$\begin{aligned} r_{y,i}^{(0)} &= g_i - F_i x_i^{(0)} - C_i y_i^{(0)} - \sum_{j \in N_i} E_{ij} y_j^{(0)} \\ &= g_i - F_i B^{-1} [f_i - E_i y_i^{(0)}] - C_i y_i^{(0)} - \sum_{j \in N_i} E_{ij} y_j^{(0)} \\ &= g_i - F_i B^{-1} f_i - S_i y_i^{(0)} - \sum_{j \in N_i} E_{ij} y_j^{(0)}. \end{aligned}$$

This is precisely the expression of the residual vector associated with the Schur complement system (13.12) with the initial guess $y_i^{(0)}$.

Now observe that the initial guess has been selected so that $r_{x,i}^{(0)} = 0$ for all i . Because only the y components of the residual vector are modified, according to line 4 of Algorithm 13.3, this property remains valid throughout the iterative process. By the updating equation (13.20) and the relation (13.7), we have

$$y_i := y_i + S_i^{-1} r_{y,i},$$

which is precisely a Gauss-Seidel step associated with the system (13.14). Note that the update of the residual vector in the algorithm results in the same update for the y components as in the Gauss-Seidel iteration for (13.14). ■

It is interesting to interpret Algorithm 13.2, or rather its discrete version, in terms of projectors. For this we follow the model of the overlapping block-Jacobi technique seen in the previous chapter. Let \mathcal{S}_i be an index set

$$\mathcal{S}_i = \{j_1, j_2, \dots, j_{n_i}\},$$

where the indices j_k are those associated with the n_i mesh points of the interior of the discrete subdomain Ω_i . Note that as before, the \mathcal{S}_i 's form a collection of index sets such that

$$\bigcup_{i=1, \dots, s} \mathcal{S}_i = \{1, \dots, n\},$$

and the \mathcal{S}_i 's are not necessarily disjoint. Let R_i be a *restriction operator* from Ω to Ω_i . By definition, $R_i x$ belongs to Ω_i and keeps only those components of an arbitrary vector x that are in Ω_i . It is represented by an $n_i \times n$ matrix of zeros and ones. The matrices R_i associated with the partitioning of Figure 13.4 are represented in the three diagrams of Figure 13.7, where each square represents a nonzero element (equal to one) and every other element is a zero. These matrices depend on the ordering chosen for the local problem. Here, boundary nodes are labeled last, for simplicity. Observe that each row of each R_i has exactly one nonzero element (equal to one). Boundary points such as the nodes 36 and 37 are represented several times in the matrices R_1, R_2 , and R_3 because of the overlapping of the boundary points. Thus, node 36 is represented in matrices R_1 and R_2 , while 37 is represented in all three matrices.

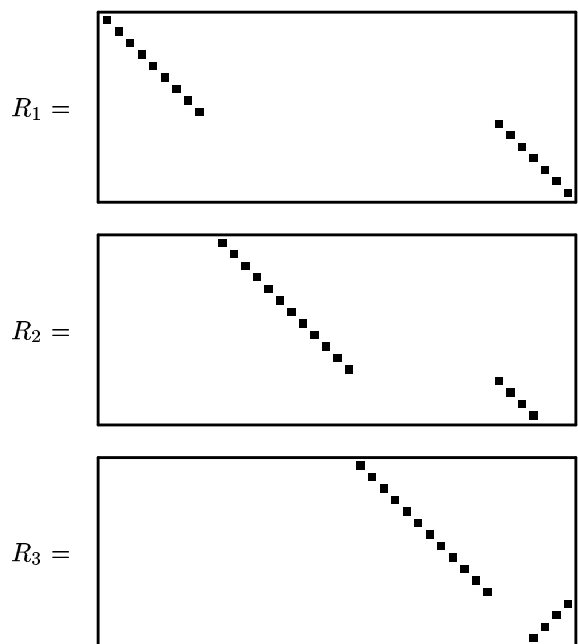

Figure 13.7 Patterns of the three matrices R_i associated with the partitioning of Figure 13.4.

From the linear algebra point of view, the restriction operator R_i is an $n_i \times n$ matrix formed by the transposes of columns e_j of the $n \times n$ identity matrix, where j belongs to the index set \mathcal{S}_i . The transpose R_i^T of this matrix is a *prolongation operator* which takes a variable from Ω_i and *extends* it to the equivalent variable in Ω . The matrix

$$A_i = R_i A R_i^T$$

of dimension $n_i \times n_i$ defines a restriction of A to Ω_i . Now a problem associated with A_i can be solved which would update the unknowns in the domain Ω_i . With this notation, the multiplicative Schwarz procedure can be described as follows:

1. For $i = 1, \dots, s$ Do
2. $x := x + R_i^T A_i^{-1} R_i (b - Ax)$
3. EndDo

We change notation and rewrite step 2 as

$$x_{new} = x + R_i^T A_i^{-1} R_i (b - Ax). \tag{13.22}$$

If the errors $d = x_* - x$ are considered where x_* is the exact solution, then notice that $b - Ax = A(x_* - x)$ and, at each iteration the following equation relates the new error d_{new} and the previous error d ,

$$d_{new} = d - R_i^T A_i^{-1} R_i A d.$$

Starting from a given x_0 whose error vector is $d_0 = x_* - x$, each sub-iteration produces an error vector which satisfies the relation

$$d_i = d_{i-1} - R_i^T A_i^{-1} R_i A d_{i-1},$$

for $i = 1, \dots, s$. As a result,

$$d_i = (I - P_i) d_{i-1}$$

in which

$$P_i = R_i^T A_i^{-1} R_i A. \quad (13.23)$$

Observe that the operator $P_i \equiv R_i^T A_i^{-1} R_i A$ is a projector since

$$(R_i^T A_i^{-1} R_i A)^2 = R_i^T A_i^{-1} (R_i A R_i^T) A_i^{-1} R_i A = R_i^T A_i^{-1} R_i A.$$

Thus, one sweep produces an error which satisfies the relation

$$d_s = (I - P_s)(I - P_{s-1}) \dots (I - P_1) d_0. \quad (13.24)$$

In the following, we use the notation

$$Q_s \equiv (I - P_s)(I - P_{s-1}) \dots (I - P_1). \quad (13.25)$$

13.3.2 MULTIPLICATIVE SCHWARZ PRECONDITIONING

Because of the equivalence of the multiplicative Schwarz procedure and a block Gauss-Seidel iteration, it is possible to recast one Multiplicative Schwarz sweep in the form of a global fixed-point iteration of the form $x_{new} = Gx + f$. Recall that this is a fixed-point iteration for solving the *preconditioned* system $M^{-1}Ax = M^{-1}b$ where the preconditioning matrix M and the matrix G are related by $G = I - M^{-1}A$. To interpret the operation associated with M^{-1} , it is helpful to identify the result of the error vector produced by this iteration with that of (13.24), which is $x_{new} - x_* = Q_s(x - x_*)$. This comparison yields,

$$x_{new} = Q_s x + (I - Q_s)x_*,$$

and therefore,

$$G = Q_s \quad f = (I - Q_s)x_*.$$

Hence, the preconditioned matrix is $M^{-1}A = I - Q_s$. This result is restated as follows.

PROPOSITION 13.2 *The multiplicative Schwarz procedure is equivalent to a fixed-point iteration for the “preconditioned” problem*

$$M^{-1}Ax = M^{-1}b,$$

in which

$$M^{-1}A = I - Q_s \quad (13.26)$$

$$M^{-1}b = (I - Q_s)x_* = (I - Q_s)A^{-1}b. \quad (13.27)$$

The transformed right-hand side in the proposition is not known explicitly since it is expressed in terms of the exact solution. However, a procedure can be found to compute it. In other words, it is possible to operate with M^{-1} without invoking A^{-1} . Note that $M^{-1} = (I - Q_s)A^{-1}$. As the next lemma indicates, M^{-1} , as well as $M^{-1}A$, can be computed recursively.

LEMMA 13.1 *Define the matrices*

$$Z_i = I - Q_i \quad (13.28)$$

$$M_i = Z_i A^{-1} \quad (13.29)$$

$$T_i = P_i A^{-1} = R_i^T A_i^{-1} R_i \quad (13.30)$$

for $i = 1, \dots, s$. Then $M^{-1} = M_s$, $M^{-1}A = Z_s$, and the matrices Z_i and M_i satisfy the recurrence relations

$$\begin{aligned} Z_1 &= P_1, \\ Z_i &= Z_{i-1} + P_i(I - Z_{i-1}), \quad i = 2, \dots, s \end{aligned} \quad (13.31)$$

and

$$\begin{aligned} M_1 &= T_1, \\ M_i &= M_{i-1} + T_i(I - AM_{i-1}), \quad i = 2, \dots, s. \end{aligned} \quad (13.32)$$

Proof. It is clear by the definitions (13.28) and (13.29) that $M_s = M^{-1}$ and that $M_1 = T_1$, $Z_1 = P_1$. For the cases $i > 1$, by definition of Q_i and Q_{i-1}

$$Z_i = I - (I - P_i)(I - Z_{i-1}) = P_i + Z_{i-1} - P_i Z_{i-1}, \quad (13.33)$$

which gives the relation (13.31). Multiplying (13.33) to the right by A^{-1} yields,

$$M_i = T_i + M_{i-1} - P_i M_{i-1}.$$

Rewriting the term P_i as $T_i A$ above yields the desired formula (13.32). \blacksquare

Note that (13.31) yields immediately the important relation

$$Z_i = \sum_{j=1}^i P_j Q_{j-1}. \quad (13.34)$$

If the relation (13.32) is multiplied to the right by a vector v and if the vector $M_i A^{-1} v$ is denoted by z_i , then the following recurrence results.

$$z_i = z_{i-1} + T_i(v - Az_{i-1}).$$

Since $z_s = (I - Q_s)A^{-1}v = M^{-1}v$, the end result is that $M^{-1}v$ can be computed for an arbitrary vector v , by the following procedure.

ALGORITHM 13.4: Multiplicative Schwarz Preconditioner

1. *Input:* v ; *Output:* $z = M^{-1}v$.
2. $z := T_1 v$
3. *For* $i = 2, \dots, s$ *Do:*

4. $z := z + T_i(v - Az)$
5. *EndDo*

By a similar argument, a procedure can be found to compute vectors of the form $z = M^{-1}Av$. In this case, the following algorithm results:

ALGORITHM 13.5: Multiplicative Schwarz Preconditioned Operator

1. *Input:* v , *Output:* $z = M^{-1}Av$.
 2. $z := P_1v$
 3. *For* $i = 2, \dots, s$ *Do*
 4. $z := z + P_i(v - z)$
 5. *EndDo*
-

In summary, the Multiplicative Schwarz procedure is equivalent to solving the “pre-conditioned system”

$$(I - Q_s)x = g \quad (13.35)$$

where the operation $z = (I - Q_s)v$ can be computed from Algorithm 13.5 and $g = M^{-1}b$ can be computed from Algorithm 13.4. Now the above procedures can be used within an accelerator such as GMRES. First, to obtain the right-hand side g of the preconditioned system (13.35), Algorithm 13.4 must be applied to the original right-hand side b . Then GMRES can be applied to (13.35) in which the preconditioned operations $I - Q_s$ are performed by Algorithm 13.5.

Another important aspect of the Multiplicative Schwarz procedure is that multicoloring can be exploited in the same way as it is done traditionally for block SOR. Finally, note that symmetry is lost in the preconditioned system but it can be recovered by following the sweep $1, 2, \dots, s$ by a sweep in the other direction, namely, $s - 1, s - 2, \dots, 1$. This yields a form of the block SSOR algorithm.

13.3.3 ADDITIVE SCHWARZ PROCEDURE

The additive Schwarz procedure is similar to a block-Jacobi iteration and consists of updating all the new (block) components from the same residual. Thus, it differs from the multiplicative procedure only because the components in each subdomain are not updated until a whole cycle of updates through all domains are completed. The basic Additive Schwarz iteration would therefore be as follows:

1. *For* $i = 1, \dots, s$ *Do*
2. *Compute* $\delta_i = R_i^T A_i^{-1} R_i(b - Ax)$
3. *EndDo*
4. $x_{new} = x + \sum_{i=1}^s \delta_i$

The new approximation (obtained after a cycle of the s substeps in the above algorithm

are applied) is

$$x_{new} = x + \sum_{i=1}^s R_i^T A_i^{-1} R_i (b - Ax).$$

Each instance of the loop redefines different components of the new approximation and there is no data dependency between the subproblems involved in the loop.

The preconditioning matrix is rather simple to obtain for the additive Schwarz procedure. Using the matrix notation defined in the previous section, notice that the new iterate satisfies the relation

$$x_{new} = x + \sum_{i=1}^s T_i (b - Ax) = \left(I - \sum_{i=1}^s P_i \right) x + \sum_{i=1}^s T_i b.$$

Thus, using the same analogy as in the previous section, this iteration corresponds to a fixed-point iteration $x_{new} = Gx + f$ with

$$G = I - \sum_{i=1}^s P_i, \quad f = \sum_{i=1}^s T_i b.$$

With the relation $G = I - M^{-1}A$, between G and the preconditioning matrix M , the result is that

$$M^{-1}A = \sum_{i=1}^s P_i,$$

and

$$M^{-1} = \sum_{i=1}^s P_i A^{-1} = \sum_{i=1}^s T_i.$$

Now the procedure for applying the preconditioned operator M^{-1} becomes clear.

ALGORITHM 13.6: Additive Schwarz Preconditioner

1. *Input:* v ; *Output:* $z = M^{-1}v$.
 2. *For* $i = 1, \dots, s$ *Do:*
 3. *Compute* $z_i := T_i v$
 4. *EndDo*
 5. *Compute* $z := z_1 + z_2 \dots + z_s$.
-

Note that the do loop can be performed in parallel. Step 5 sums up the vectors z_i in each domain to obtain a global vector z . In the nonoverlapping case, this step is parallel and consists of just forming these different components since the addition is trivial. In the presence of overlap, the situation is similar except that the overlapping components are added up from the different results obtained in each subdomain.

The procedure for computing $M^{-1}Av$ is identical to the one above except that T_i in line 3 is replaced by P_i .

13.3.4 CONVERGENCE

Throughout this section, it is assumed that A is Symmetric Positive Definite. The projectors P_i defined by (13.23) play an important role in the convergence theory of both additive and multiplicative Schwarz. A crucial observation here is that these projectors are orthogonal with respect to the A -inner product. Indeed, it is sufficient to show that P_i is self-adjoint with respect to the A -inner product,

$$(P_i x, y)_A = (A R_i^T A_i^{-1} R_i A x, y) = (A x, R_i^T A_i^{-1} R_i A y) = (x, P_i y)_A.$$

Consider the operator,

$$A_J = \sum_{i=1}^s P_i. \quad (13.36)$$

Since each P_j is self-adjoint with respect to the A -inner product, i.e., A -self-adjoint, their sum A_J is also A -self-adjoint. Therefore, it will have real eigenvalues. An immediate consequence of the fact that the P_i 's are projectors is stated in the following theorem.

THEOREM 13.2 *The largest eigenvalue of A_J is such that*

$$\lambda_{max}(A_J) \leq s,$$

where s is the number of subdomains.

Proof. For any matrix norm, $\lambda_{max}(A_J) \leq \|A_J\|$. In particular, if the A -norm is used, we have

$$\lambda_{max}(A_J) \leq \sum_{i=1}^s \|P_i\|_A.$$

Each of the A -norms of P_i is equal to one since P_i is an A -orthogonal projector. This proves the desired result. ■

This result can be improved substantially by observing that the projectors can be grouped in sets that have disjoint ranges. Graph coloring techniques seen in Chapter 3 can be used to obtain such colorings of the subdomains. Assume that c sets of indices $\Theta_i, i = 1, \dots, c$ are such that all the subdomains Ω_j for $j \in \Theta_i$ have no intersection with one another. Then,

$$P_{\Theta_i} = \sum_{j \in \Theta_i} P_j \quad (13.37)$$

is again an orthogonal projector.

This shows that the result of the previous theorem can be improved trivially into the following.

THEOREM 13.3 *Suppose that the subdomains can be colored in such a way that two subdomains with the same color have no common nodes. Then, the largest eigenvalue of A_J is such that*

$$\lambda_{max}(A_J) \leq c,$$

where c is the number of colors.

In order to estimate the lowest eigenvalue of the preconditioned matrix, an assumption must be made regarding the decomposition of an arbitrary vector x into components of Ω_i .

Assumption 1. *There exists a constant K_0 such that the inequality*

$$\sum_{i=1}^s (Au_i, u_i) \leq K_0 (Au, u),$$

is satisfied by the representation of $u \in \Omega$ as the sum

$$u = \sum_{i=1}^s u_i, \quad u_i \in \Omega_i.$$

The following theorem has been proved by several authors in slightly different forms and contexts.

THEOREM 13.4 *If Assumption 1 holds, then*

$$\lambda_{\min}(A_J) \geq \frac{1}{K_0}.$$

Proof. Unless otherwise stated, all summations in this proof are from 1 to s . Start with an arbitrary u decomposed as $u = \sum u_i$ and write

$$(u, u)_A = \sum (u_i, u)_A = \sum (P_i u_i, u)_A = \sum (u_i, P_i u)_A.$$

The last equality is due to the fact that P_i is an A -orthogonal projector onto Ω_i and it is therefore self-adjoint. Now, using Cauchy-Schwarz inequality, we get

$$(u, u)_A = \sum (u_i, P_i u)_A \leq \left(\sum (u_i, u_i)_A \right)^{1/2} \left(\sum (P_i u, P_i u)_A \right)^{1/2}.$$

By Assumption 1, this leads to

$$\|u\|_A^2 \leq K_0^{1/2} \|u\|_A \left(\sum (P_i u, P_i u)_A \right)^{1/2},$$

which, after squaring, yields

$$\|u\|_A^2 \leq K_0 \sum (P_i u, P_i u)_A.$$

Finally, observe that since each P_i is an A -orthogonal projector, we have

$$\sum (P_i u, P_i u)_A = \sum (P_i u, u)_A = \left(\sum P_i u, u \right)_A.$$

Therefore, for any u , the inequality

$$(A_J u, u)_A \geq \frac{1}{K_0} (u, u)_A$$

holds, which yields the desired upper bound by the min-max theorem. ■

Note that the proof uses the following form of the Cauchy-Schwarz inequality:

$$\sum_{i=1}^p (x_i, y_i) \leq \left(\sum_{i=1}^p (x_i, x_i) \right)^{1/2} \left(\sum_{i=1}^p (y_i, y_i) \right)^{1/2}.$$

See Exercise 1 for a proof of this variation.

We now turn to the analysis of the Multiplicative Schwarz procedure. We start by recalling that the error after each outer iteration (sweep) is given by

$$d = Q_s d_0.$$

We wish to find an upper bound for $\|Q_s\|_A$. First note that (13.31) in Lemma 13.1 results in

$$Q_i = Q_{i-1} - P_i Q_{i-1},$$

from which we get, using the A -orthogonality of P_i ,

$$\|Q_i v\|_A^2 = \|Q_{i-1} v\|_A^2 - \|P_i Q_{i-1} v\|_A^2.$$

The above equality is valid for $i = 1$, provided $Q_0 \equiv I$. Summing these equalities from $i = 1$ to s gives the result,

$$\|Q_s v\|_A^2 = \|v\|_A^2 - \sum_{i=1}^s \|P_i Q_{i-1} v\|_A^2. \quad (13.38)$$

This indicates that the A -norm of the error will not increase at each substep of the sweep.

Now a second assumption must be made to prove the next lemma.

Assumption 2. For any subset S of $\{1, 2, \dots, s\}^2$ and $u_i, v_j \in \Omega$, the following inequality holds:

$$\sum_{(i,j) \in S} (P_i v_i, P_j v_j)_A \leq K_1 \left(\sum_{i=1}^s \|P_i u_i\|_A^2 \right)^{1/2} \left(\sum_{j=1}^s \|P_j v_j\|_A^2 \right)^{1/2}. \quad (13.39)$$

LEMMA 13.2 If Assumptions 1 and 2 are satisfied, then the following is true,

$$\sum_{i=1}^s \|P_i v\|_A^2 \leq (1 + K_1)^2 \sum_{i=1}^s \|P_i Q_{i-1} v\|_A^2. \quad (13.40)$$

Proof. Begin with the relation which follows from the fact that P_i is an A -orthogonal projector,

$$(P_i v, P_i v)_A = (P_i v, P_i Q_{i-1} v)_A + (P_i v, (I - Q_{i-1}) v)_A,$$

which yields, with the help of (13.34),

$$\sum_{i=1}^s \|P_i v\|_A^2 = \sum_{i=1}^s (P_i v, P_i Q_{i-1} v)_A + \sum_{i=1}^s \sum_{j=1}^{i-1} (P_i v, P_j Q_{j-1} v)_A. \quad (13.41)$$

For the first term of the right-hand side, use the Cauchy-Schwarz inequality to obtain

$$\sum_{i=1}^s (P_i v, P_i Q_{i-1} v)_A \leq \left(\sum_{i=1}^s \|P_i v\|_A^2 \right)^{1/2} \left(\sum_{i=1}^s \|P_i Q_{i-1} v\|_A^2 \right)^{1/2}.$$

For the second term of the right-hand side of (13.41), use the assumption (13.39) to get

$$\sum_{i=1}^s \sum_{j=1}^{i-1} (P_i v, P_j Q_{j-1} v)_A \leq K_1 \left(\sum_{i=1}^s \|P_i v\|_A^2 \right)^{1/2} \left(\sum_{j=1}^s \|P_j Q_{j-1} v\|_A^2 \right)^{1/2}.$$

Adding these two inequalities, squaring the result, and using (13.41) leads to the inequality (13.40). ■

From (13.38), it can be deduced that if Assumption 2 holds, then,

$$\|Q_s v\|_A^2 \leq \|v\|_A^2 - \frac{1}{(1 + K_1)^2} \sum_{i=1}^s \|P_i v\|_A^2. \quad (13.42)$$

Assumption 1 can now be exploited to derive a lower bound on $\sum_{i=1}^s \|P_i v\|_A^2$. This will yield the following theorem.

THEOREM 13.5 *Assume that Assumptions 1 and 2 hold. Then,*

$$\|Q_s\|_A \leq \left[1 - \frac{1}{K_0(1 + K_1)^2} \right]^{1/2}. \quad (13.43)$$

Proof. Using the notation of Section 13.3.3, the relation $\|P_i v\|_A^2 = (P_i v, v)_A$ yields

$$\sum_{i=1}^s \|P_i v\|_A^2 = \left(\sum_{i=1}^s P_i v, v \right)_A = (A_J v, v)_A.$$

According to Theorem 13.4, $\lambda_{\min}(A_J) \geq \frac{1}{K_0}$, which implies $(A_J v, v)_A \geq (v, v)_A / K_0$. Thus,

$$\sum_{i=1}^s \|P_i v\|_A^2 \geq \frac{(v, v)_A}{K_0},$$

which upon substitution into (13.42) gives the inequality

$$\frac{\|Q_s v\|_A^2}{\|v\|_A^2} \leq 1 - \frac{1}{K_0(1 + K_1)^2}.$$

The result follows by taking the maximum over all vectors v . ■

This result provides information on the speed of convergence of the multiplicative Schwarz procedure by making two key assumptions. These assumptions are not verifiable from linear algebra arguments alone. In other words, given a linear system, it is unlikely that one can establish that these assumptions are satisfied. However, they are satisfied for equations originating from finite element discretization of elliptic Partial Differential Equations. For details, refer to Drya and Widlund [72, 73, 74] and Xu [230].

 SCHUR COMPLEMENT APPROACHES

13.4

Schur complement methods are based on solving the reduced system (13.4) by some preconditioned Krylov subspace method. Procedures of this type involve three steps.

1. Get the right-hand side $g' = g - FB^{-1}f$.
2. Solve the reduced system $Sy = g'$ via an iterative method.
3. Back-substitute, i.e., compute x via (13.3).

The different methods relate to the way in which step 2 is performed. First observe that the matrix S need not be formed explicitly in order to solve the reduced system by an iterative method. For example, if a Krylov subspace method without preconditioning is used, then the only operations that are required with the matrix S are matrix-by-vector operations $w = Sv$. Such operations can be performed as follows.

1. Compute $v' = Ev$,
2. Solve $Bz = v'$
3. Compute $w = Cv - Fz$.

The above procedure involves only matrix-by-vector multiplications and one linear system solution with B . Recall that a linear system involving B translates into s -independent linear systems. Also note that the linear systems with B must be solved exactly, either by a direct solution technique or by an iterative technique with a high level of accuracy.

While matrix-by-vector multiplications with S cause little difficulty, it is much harder to precondition the matrix S , since this full matrix is often not available explicitly. There have been a number of methods, derived mostly using arguments from Partial Differential Equations to precondition the Schur complement. Here, we consider only those preconditioners that are derived from a linear algebra viewpoint.

13.4.1 INDUCED PRECONDITIONERS

One of the easiest ways to derive an approximation to S is to exploit Proposition 13.1 and the intimate relation between the Schur complement and Gaussian elimination. This proposition tells us that a preconditioning operator M to S can be defined from the (approximate) solution obtained with A . To precondition a given vector v , i.e., to compute $w = M^{-1}v$, where M is the desired preconditioner to S , first solve the system

$$A \begin{pmatrix} x \\ y \end{pmatrix} = \begin{pmatrix} 0 \\ v \end{pmatrix}, \quad (13.44)$$

then take $w = y$. Use any approximate solution technique to solve the above system. Let M_A be any preconditioner for A . Using the notation defined earlier, let R_y represent the restriction operator on the interface variables, as defined in Proposition 13.1. Then the

preconditioning operation for S which is induced from M_A is defined by

$$M_S^{-1}v = R_y M_A^{-1} \begin{pmatrix} 0 \\ v \end{pmatrix} = R_y M_A^{-1} R_y^T v.$$

Observe that when M_A is an exact preconditioner, i.e., when $M_A = A$, then according to Proposition 13.1, M_S is also an exact preconditioner, i.e., $M_S = S$. This induced preconditioner can be expressed as

$$M_S = (R_y M_A^{-1} R_y^T)^{-1}. \quad (13.45)$$

It may be argued that this uses a preconditioner related to the original problem to be solved in the first place. However, even though the preconditioning on S may be defined from a preconditioning of A , the linear system is being solved for the interface variables. That is typically much smaller than the original linear system. For example, GMRES can be used with a much larger dimension of the Krylov subspace since the Arnoldi vectors to keep in memory are much smaller. Also note that from a Partial Differential Equations viewpoint, systems of the form (13.44) correspond to the Laplace equation, the solutions of which are ‘‘Harmonic’’ functions. There are fast techniques which provide the solution of such equations inexpensively.

In the case where M_A is an ILU factorization of A , M_S can be expressed in an explicit form in terms of the entries of the factors of M_A . This defines a preconditioner to S that is induced canonically from an incomplete LU factorization of A . Assume that the preconditioner M_A is in a factored form $M_A = L_A U_A$, where

$$L_A = \begin{pmatrix} L_B & 0 \\ F U_B^{-1} & L_S \end{pmatrix} \quad U_A = \begin{pmatrix} U_B & L_B^{-1} E \\ 0 & U_S \end{pmatrix}.$$

Then, the inverse of M_A will have the following structure:

$$\begin{aligned} M_A^{-1} &= U_A^{-1} L_A^{-1} \\ &= \begin{pmatrix} \star & \star \\ 0 & U_S^{-1} \end{pmatrix} \begin{pmatrix} \star & 0 \\ \star & L_S^{-1} \end{pmatrix} \\ &= \begin{pmatrix} \star & \star \\ \star & U_S^{-1} L_S^{-1} \end{pmatrix} \end{aligned}$$

where a star denotes a matrix whose actual expression is unimportant. Recall that by definition,

$$R_y = \begin{pmatrix} 0 & I \end{pmatrix},$$

where this partitioning conforms to the above ones. This means that

$$R_y M_A^{-1} R_y^T = U_S^{-1} L_S^{-1}$$

and, therefore, according to (13.45), $M_S = L_S U_S$. This result is stated in the following proposition.

PROPOSITION 13.3 *Let $M_A = L_A U_A$ be an ILU preconditioner for A . Then the preconditioner M_S for S induced by M_A , as defined by (13.45), is given by*

$$M_S = L_S U_S, \quad \text{with } L_S = R_y L_A R_y^T, \quad U_S = R_y U_A R_y^T.$$

In words, the proposition states that the L and U factors for M_S are the $(2, 2)$ blocks of the L and U factors of the ILU factorization of A . An important consequence of the above idea is that the parallel Gaussian elimination can be exploited for deriving an ILU preconditioner for S by using a general purpose ILU factorization. In fact, the L and U factors of M_A have the following structure:

$$A = L_A U_A - R \quad \text{with,}$$

$$L_A = \begin{pmatrix} L_1 & & & & \\ & L_2 & & & \\ & & \ddots & & \\ & & & L_s & \\ F_1 U_1^{-1} & F_2 U_2^{-1} & \dots & F_s U_s^{-1} & L \end{pmatrix}$$

$$U_A = \begin{pmatrix} U_1 & & & L_1^{-1} E_1 \\ & U_2 & & L_2^{-1} E_2 \\ & & \ddots & \vdots \\ & & & U_s & L_s^{-1} E_s \\ & & & & U \end{pmatrix}.$$

Each L_i, U_i pair is an incomplete LU factorization of the local B_i matrix. These ILU factorizations can be computed independently. Similarly, the matrices $L_i^{-1} E_i$ and $F_i U_i^{-1}$ can also be computed independently once the LU factors are obtained. Then each of the matrices

$$\tilde{S}_i = C_i - F_i U_i^{-1} L_i^{-1} E_i,$$

which are the approximate local Schur complements, is obtained. Note that since an incomplete LU factorization is being performed, some drop strategy is applied to the elements in \tilde{S}_i . Let T_i be the matrix obtained after this is done,

$$T_i = \tilde{S}_i - R_i.$$

Then a final stage would be to compute the ILU factorization of the matrix (13.14) where each S_i is replaced by T_i .

13.4.2 PROBING

To derive preconditioners for the Schur complement, another general purpose technique exploits ideas used in approximating sparse Jacobians when solving nonlinear equations. In general, S is a dense matrix. However, it can be observed, and there are physical justifications for model problems, that its entries decay away from the main diagonal. Assume that S is nearly tridiagonal, i.e., neglect all diagonals apart from the main diagonal and the two codiagonals, and write the corresponding tridiagonal approximation to S as

$$T = \begin{pmatrix} a_1 & b_2 & & & \\ c_2 & a_2 & b_3 & & \\ & \ddots & \ddots & \ddots & \\ & & c_{m-1} & a_{m-1} & b_m \\ & & & c_m & a_m \end{pmatrix}.$$

Then, it is easy to recover T by applying it to three well-chosen vectors. Consider the three vectors

$$\begin{aligned} w_1 &= (1, 0, 0, 1, 0, 0, 1, 0, 0, \dots)^T, \\ w_2 &= (0, 1, 0, 0, 1, 0, 0, 1, 0, \dots)^T, \\ w_3 &= (0, 0, 1, 0, 0, 1, 0, 0, 1, \dots)^T. \end{aligned}$$

Then we have

$$\begin{aligned} Tw_1 &= (a_1, c_2, b_4, a_4, c_5, \dots, b_{3i+1}, a_{3i+1}, c_{3i+2}, \dots)^T, \\ Tw_2 &= (b_2, a_2, c_3, b_5, a_5, c_6, \dots, b_{3i+2}, a_{3i+2}, c_{3i+3}, \dots)^T, \\ Tw_3 &= (b_3, a_3, c_4, b_6, a_6, c_7, \dots, b_{3i}, a_{3i}, c_{3i+1}, \dots)^T. \end{aligned}$$

This shows that all the coefficients of the matrix T are indeed all represented in the above three vectors. The first vector contains the nonzero elements of the columns 1, 4, 7, \dots , $3i + 1, \dots$, in succession written as a long vector. Similarly, Tw_2 contains the columns 2, 5, 8, \dots , and Tw_3 contains the columns 3, 6, 9, \dots . We can easily compute Sw_i , $i = 1, 3$ and obtain a resulting approximation T which can be used as a preconditioner to S . The idea can be extended to compute any banded approximation to S . For details and analysis see [49].

13.4.3 PRECONDITIONING VERTEX-BASED SCHUR COMPLEMENTS

We now discuss some issues related to the preconditioning of a linear system with the matrix coefficient of (13.14) associated with a vertex-based partitioning. As was mentioned before, this structure is helpful in the direct solution context because it allows the Schur complement to be formed by local pieces. Since incomplete LU factorizations will utilize the same structure, this can be exploited as well.

Note that multicolor SOR or SSOR can also be exploited and that graph coloring can be used to color the interface values y_i in such a way that no two adjacent interface variables will have the same color. In fact, this can be achieved by coloring the domains. In the course of a multicolor block-SOR iteration, a linear system must be solved with the diagonal blocks S_i . For this purpose, it is helpful to interpret the Schur complement. Call P the canonical injection matrix from the local interface points to the local nodes. If n_i points are local and if m_i is the number of the local interface points, then P is an $n_i \times m_i$ matrix whose columns are the last m_i columns of the $n_i \times n_i$ identity matrix. Then it is easy to see that

$$S_i = (P^T A_{loc,i}^{-1} P)^{-1}. \quad (13.46)$$

If $A_{loc,i} = LU$ is the LU factorization of $A_{loc,i}$ then it can be verified that

$$S_i^{-1} = P^T U^{-1} L^{-1} P = P^T U^{-1} P P^T L^{-1} P, \quad (13.47)$$

which indicates that in order to operate with $P^T L^{-1} P$, the last $m_i \times m_i$ principal submatrix of L must be used. The same is true for $P^T U^{-1} P$ which requires only a back-solve with the last $m_i \times m_i$ principal submatrix of U . Therefore, only the LU factorization of $A_{loc,i}$ is

needed to solve a system with the matrix S_i . Interestingly, approximate solution methods associated with incomplete factorizations of $A_{loc,i}$ can be exploited.

FULL MATRIX METHODS

13.5

We call any technique that iterates on the original system (13.2) a *full matrix method*. In the same way that preconditioners were derived from the LU factorization of A for the Schur complement, preconditioners for A can be derived from approximating interface values.

Before starting with preconditioning techniques, we establish a few simple relations between iterations involving A and S .

PROPOSITION 13.4 *Let*

$$L_A = \begin{pmatrix} I & O \\ FB^{-1} & I \end{pmatrix}, \quad U_A = \begin{pmatrix} B & E \\ O & I \end{pmatrix} \quad (13.48)$$

and assume that a Krylov subspace method is applied to the original system (13.1) with left preconditioning L_A and right preconditioning U_A , and with an initial guess of the form

$$\begin{pmatrix} x_0 \\ y_0 \end{pmatrix} = \begin{pmatrix} B^{-1}(f - Ey_0) \\ y_0 \end{pmatrix}. \quad (13.49)$$

Then this preconditioned Krylov iteration will produce iterates of the form

$$\begin{pmatrix} x_m \\ y_m \end{pmatrix} = \begin{pmatrix} B^{-1}(f - Ey_m) \\ y_m \end{pmatrix} \quad (13.50)$$

in which the sequence y_m is the result of the same Krylov subspace method applied without preconditioning to the reduced linear system $Sy = g'$ with $g' = g - FB^{-1}f$ starting with the vector y_0 .

Proof. The proof is a consequence of the factorization

$$\begin{pmatrix} B & E \\ F & C \end{pmatrix} = \begin{pmatrix} I & O \\ FB^{-1} & I \end{pmatrix} \begin{pmatrix} I & O \\ O & S \end{pmatrix} \begin{pmatrix} B & E \\ O & I \end{pmatrix}. \quad (13.51)$$

Applying an iterative method (e.g., GMRES) on the original system, preconditioned from the left by L_A and from the right by U_A , is equivalent to applying this iterative method to

$$L_A^{-1}AU_A^{-1} = \begin{pmatrix} I & O \\ O & S \end{pmatrix} \equiv A'. \quad (13.52)$$

The initial residual for the preconditioned system is

$$\begin{aligned} L_A^{-1} \begin{pmatrix} f \\ g \end{pmatrix} - (L_A^{-1}AU_A^{-1})U_A \begin{pmatrix} x_0 \\ y_0 \end{pmatrix} \\ = \begin{pmatrix} I & O \\ -FB^{-1} & I \end{pmatrix} \left(\begin{pmatrix} f \\ g \end{pmatrix} - \begin{pmatrix} FB^{-1}(f - Ey_0) + Cy_0 \end{pmatrix} \right) \end{aligned}$$

$$= \begin{pmatrix} 0 \\ g' - Sy_0 \end{pmatrix} \equiv \begin{pmatrix} 0 \\ r_0 \end{pmatrix}.$$

As a result, the Krylov vectors obtained from the preconditioned linear system associated with the matrix A' have the form

$$\begin{pmatrix} 0 \\ r_0 \end{pmatrix}, \begin{pmatrix} 0 \\ Sr_0 \end{pmatrix}, \dots, \begin{pmatrix} 0 \\ S^{m-1}r_0 \end{pmatrix} \quad (13.53)$$

and the associated approximate solution will be of the form

$$\begin{aligned} \begin{pmatrix} x_m \\ y_m \end{pmatrix} &= \begin{pmatrix} x_0 \\ y_0 \end{pmatrix} + \begin{pmatrix} B^{-1} & -B^{-1}E \\ O & I \end{pmatrix} \begin{pmatrix} 0 \\ \sum_{i=0}^{m-1} \alpha_i S^i r_0 \end{pmatrix} \\ &= \begin{pmatrix} B^{-1}(f - Ey_0) - B^{-1}E(y_m - y_0) \\ y_m \end{pmatrix} \\ &= \begin{pmatrix} B^{-1}(f - Ey_m) \\ y_m \end{pmatrix}. \end{aligned}$$

Finally, the scalars α_i that express the approximate solution in the Krylov basis are obtained implicitly via inner products of vectors among the vector sequence (13.53). These inner products are identical to those of the sequence $r_0, Sr_0, \dots, S^{m-1}r_0$. Therefore, these coefficients will achieve the same result as the same Krylov method applied to the reduced system $Sy = g'$, if the initial guess gives the residual guess r_0 . ■

A version of this proposition should allow S to be preconditioned. The following result is an immediate extension that achieves this goal.

PROPOSITION 13.5 *Let $S = L_S U_S - R$ be an approximate factorization of S and define*

$$L_A = \begin{pmatrix} I & O \\ FB^{-1} & L_S \end{pmatrix}, \quad U_A = \begin{pmatrix} B & E \\ O & U_S \end{pmatrix}. \quad (13.54)$$

Assume that a Krylov subspace method is applied to the original system (13.1) with left preconditioning L_A and right preconditioning U_A , and with an initial guess of the form

$$\begin{pmatrix} x_0 \\ y_0 \end{pmatrix} = \begin{pmatrix} B^{-1}(f - Ey_0) \\ y_0 \end{pmatrix}. \quad (13.55)$$

Then this preconditioned Krylov iteration will produce iterates of the form

$$\begin{pmatrix} x_m \\ y_m \end{pmatrix} = \begin{pmatrix} B^{-1}(f - Ey_m) \\ y_m \end{pmatrix}. \quad (13.56)$$

Moreover, the sequence y_m is the result of the same Krylov subspace method applied to the reduced linear system $Sy = g - FB^{-1}f$, left preconditioned with L_S , right preconditioned with U_S , and starting with the vector y_0 .

Proof. The proof starts with the equality

$$\begin{pmatrix} B & E \\ F & C \end{pmatrix} = \begin{pmatrix} I & O \\ FB^{-1} & L_S \end{pmatrix} \begin{pmatrix} I & O \\ O & L_S^{-1} S U_S^{-1} \end{pmatrix} \begin{pmatrix} B & E \\ O & U_S \end{pmatrix}. \quad (13.57)$$

The rest of the proof is similar to that of the previous result and is omitted. ■

Also there are two other versions in which S is allowed to be preconditioned from the left or from the right. Thus, if M_S is a certain preconditioner for S , use the following factorizations

$$\begin{pmatrix} B & E \\ F & C \end{pmatrix} = \begin{pmatrix} I & O \\ FB^{-1} & M_S \end{pmatrix} \begin{pmatrix} I & O \\ O & M_S^{-1}S \end{pmatrix} \begin{pmatrix} B & E \\ O & I \end{pmatrix} \quad (13.58)$$

$$= \begin{pmatrix} I & O \\ FB^{-1} & I \end{pmatrix} \begin{pmatrix} I & O \\ O & SM_S^{-1} \end{pmatrix} \begin{pmatrix} B & E \\ O & M_S \end{pmatrix}, \quad (13.59)$$

to derive the appropriate left or right preconditioners. Observe that when the preconditioner M_S to S is exact, i.e., when $M = S$, then the block preconditioner L_A, U_A to A induced from M_S is also exact.

Although the previous results indicate that a Preconditioned Schur Complement iteration is mathematically equivalent to a certain preconditioned full matrix method, there are some practical benefits in iterating with the nonreduced system. The main benefit involves the requirement in the Schur Complement techniques to compute Sx exactly at each Krylov subspace iteration. Indeed, the matrix S represents the coefficient matrix of the linear system, and inaccuracies in the matrix-by-vector operation may result in loss of convergence. In the full matrix techniques, the operation Sx is never needed explicitly. In addition, this opens up the possibility of preconditioning the original matrix with approximate solves with the matrix B in the preconditioning operation L_A and U_A .

GRAPH PARTITIONING

13.6

The very first task that a programmer faces when solving a problem on a parallel computer, be it a dense or a sparse linear system, is to decide how to map the data into the processors. For shared memory and SIMD computers, directives are often provided to help the user input a desired mapping, among a small set of choices. Distributed memory computers are more general since they allow mapping the data in an arbitrary fashion. However, this added flexibility puts the burden on the user to find good mappings. In particular, when implementing Domain Decomposition ideas on a parallel computer, efficient techniques must be available for partitioning an arbitrary graph. This section gives an overview of the issues and covers a few techniques.

13.6.1 BASIC DEFINITIONS

Consider a general sparse linear system whose adjacency graph is $G = (V, E)$. There are two issues related to the distribution of mapping a general sparse linear system on a number of processors. First, a good partitioning must be found for the original problem. This translates into partitioning the graph G into subgraphs and can be viewed independently from the underlying architecture or topology. The second issue, which is architecture dependent, is to find a good mapping of the subdomains or subgraphs to the processors, after

the partitioning has been found. Clearly, the partitioning algorithm can take advantage of a measure of quality of a given partitioning by determining different weight functions for the vertices, for vertex-based partitionings. Also, a good mapping could be found to minimize communication costs, given some knowledge on the architecture.

Graph partitioning algorithms address only the first issue. Their goal is to subdivide the graph into smaller subgraphs in order to achieve a good load balancing of the work among the processors and ensure that the ratio of communication over computation is small for the given task. We begin with a general definition.

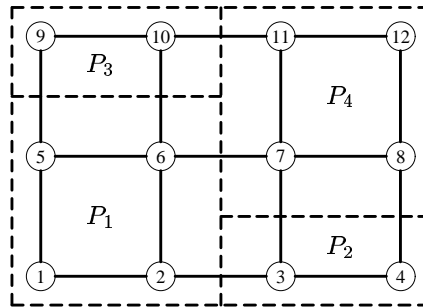

Figure 13.8 Mapping of a simple 4×3 mesh to 4 processors.

DEFINITION 13.1 We call a map of V , any set V_1, V_2, \dots, V_s , of subsets of the vertex set V , whose union is equal to V :

$$V_i \subseteq V, \quad \bigcup_{i=1,s} V_i = V.$$

When all the V_i subsets are disjoint, the map is called a proper partition; otherwise we refer to it as an overlapping partition.

The most general way to describe a node-to-processor mapping is by setting up a list for each processor, containing all the nodes that are mapped to that processor. Three distinct classes of algorithms have been developed for partitioning graphs. An overview of each of these three approaches is given next.

13.6.2 GEOMETRIC APPROACH

The geometric approach works on the physical mesh and requires the coordinates of the mesh points to find adequate partitionings. In the simplest case, for a 2-dimensional rectangular grid, stripes in the horizontal and vertical direction can be defined to get square subregions which have roughly the same number of points. Other techniques utilize notions of moment of inertia to divide the region recursively into two roughly equal-sized subregions.

Next is a very brief description of a technique based on work by Miller, Teng, Thurston, and Vavasis [150]. This technique finds good separators for a mesh using projections

into a higher space. Given a mesh in \mathbb{R}^d , the method starts by projecting the mesh points into a unit sphere centered at the origin in \mathbb{R}^{d+1} . Stereographic projection is used: A line is drawn from a given point p in the plane to the North Pole $(0, \dots, 0, 1)$ and the stereographic projection of p is the point where this line intersects the sphere. In the next step, a *centerpoint* of the projected points is found. A centerpoint c of a discrete set S is defined as a point where every hyperplane passing through c will divide S approximately evenly. Once the centerpoint is found, the points of the sphere are rotated so that the centerpoint is aligned with the North Pole, i.e., so that coordinates of c are transformed into $(0, \dots, 0, r)$. The points are further transformed by dilating them so that the centerpoint becomes the origin. Through all these transformations, the point c remains a centerpoint. Therefore, if any hyperplane is taken that passes through the centerpoint which is now the origin, it should cut the sphere into two roughly equal-sized subsets. Any hyperplane passing through the origin will intersect the sphere along a large circle C . Transforming this circle back into the original space will give a desired separator. Notice that there is an infinity of circles to choose from. One of the main ingredients in the above algorithm is a heuristic for finding centerpoints in \mathbb{R}^d space (actually, \mathbb{R}^{d+1} in the algorithm). The heuristic that is used repeatedly replaces randomly chosen sets of $d+2$ points by their centerpoint, which are easy to find in this case.

There are a number of interesting results that analyze the quality of geometric graph partitionings based on separators. With some minimal assumptions on the meshes, it is possible to show that there exist “good” separators. In addition, the algorithm discussed above constructs such separators. We start with two definitions.

DEFINITION 13.2 A k -ply neighborhood system in \mathbb{R}^d is a set of n closed disks D_i , $i = 1, \dots, n$ in \mathbb{R}^d such that no point in \mathbb{R}^d is (strictly) interior to more than k disks.

DEFINITION 13.3 Let $\alpha \geq 1$ and let D_1, \dots, D_n be a k -ply neighborhood system in \mathbb{R}^d . The (α, k) -overlap graph for the neighborhood system is the graph with vertex set $V = \{1, 2, \dots, n\}$ and edge set, the subset of $V \times V$ defined by

$$\{(i, j) : (D_i \cap (\alpha \cdot D_j) \neq \emptyset) \text{ and } (D_j \cap (\alpha \cdot D_i) \neq \emptyset)\}.$$

A mesh in \mathbb{R}^d is associated with an overlap graph by assigning the coordinate of the center c_i of disk i to each node i of the graph. Overlap graphs model computational meshes in d dimensions. Indeed, every mesh with bounded *aspect ratio* elements (ratio of largest to smallest edge length of each element) is contained in an overlap graph. In addition, any planar graph is an overlap graph. The main result regarding separators of overlap graphs is the following theorem [150].

THEOREM 13.6 Let G be an n -vertex (α, k) overlap graph in d dimensions. Then the vertices of G can be partitioned into three sets A, B , and C such that:

1. No edge joins A and B .
2. A and B each have at most $n(d+1)/(d+2)$ vertices.
3. C has only $O(\alpha k^{1/d} n^{(d-1)/d})$ vertices.

Thus, for $d = 2$, the theorem states that it is possible to partition the graph into two

subgraphs A and B , with a separator C , such that the number of nodes for each of A and B does not exceed $\frac{3}{4}n$ vertices in the worst case and such that the separator has a number of nodes of the order $O(\alpha k^{1/2}n^{1/2})$.

13.6.3 SPECTRAL TECHNIQUES

Spectral bisection refers to a technique which exploits some known properties of the eigenvectors of the *Laplacian of a graph*. Given an adjacency graph $G = (V, E)$, we associate to it a Laplacian matrix L which is a sparse matrix having the same adjacency graph G and defined as follows:

$$l_{ij} = \begin{cases} -1 & \text{if } (v_i, v_j) \in E \text{ and } i \neq j \\ \text{deg}(i) & \text{if } i = j \\ 0 & \text{otherwise.} \end{cases}$$

There are some interesting fundamental properties of such matrices. Assuming the graph is undirected, the matrix is symmetric. It can easily be seen that it is also *negative semi-definite* (see Exercise 9). Zero is an eigenvalue and it is the smallest one. An eigenvector associated with this eigenvalue is any constant vector, and this eigenvector bears little interest. However, the second smallest eigenvector, called the *Fiedler vector*, has the useful property that the signs of its components divide the domain into roughly two equal subdomains. To be more accurate, the Recursive Spectral Bisection (RSB) algorithm consists of sorting the components of the eigenvector and assigning the first half of the sorted vertices to the first subdomain and the second half to the second subdomain. The two subdomains are then partitioned in two recursively, until a desirable number of domains is reached.

ALGORITHM 13.7: RSB (Recursive Spectral Bisection)

1. Compute the Fiedler vector f of the graph G .
2. Sort the components of f , e.g., increasingly.
3. Assign first $\lfloor n/2 \rfloor$ nodes to V_1 , and the rest to V_2 .
4. Apply RSB recursively to V_1, V_2 , until the desired number of partitions
5. is reached.

The main theoretical property that is exploited here is that the differences between the components of the Fiedler vector represent some sort of distance between the corresponding nodes. Thus, if these components are sorted they would be grouping effectively the associated node by preserving nearness. In addition, another interesting fact is that the algorithm will also tend to minimize the number n_c of *cut-edges*, i.e., the number of edges (v_i, v_j) such that $v_i \in V_1$ and $v_j \in V_2$. Let p be a *partition vector* whose components are $+1$ or -1 in equal number, so that $e^T p = 0$ where $e = (1, 1, \dots, 1)^T$. Assume that V_1 and V_2 are of equal size and that the components of p are set to $+1$ for those in V_1 and -1 for those in V_2 . Then notice that

$$(Lp, p) = 4n_c, \quad (p, e) = 0.$$

Ideally, the objective function (Lp, p) should be minimized subject to the constraint that

$(p, e) = 0$. Note that here p is a vector of signs. If, instead, the objective function $(Lx, x)/(x, x)$ were minimized with respect to the constraint $(x, e) = 0$ for x real, the solution would be the Fiedler vector, since e is the eigenvector associated with the eigenvalue zero. The Fiedler vector is an eigenvector associated with the second smallest eigenvalue of L . This eigenvector can be computed by the Lanczos algorithm or any other method efficient for large sparse matrices. Recursive Spectral Bisection gives excellent partitionings. On the other hand, it is rather expensive because of the requirement to compute eigenvectors.

13.6.4 GRAPH THEORY TECHNIQUES

There exist a number of other techniques which, like spectral techniques, are also based on the adjacency graph only. The simplest idea is one that is borrowed from the technique of *nested dissection* in the context of direct sparse solution methods. Refer to Chapter 3 where level set orderings are described. An initial node is given which constitutes the level zero. Then, the method recursively traverses the k -th level ($k \geq 1$), which consists of the neighbors of all the elements that constitute level $k - 1$. A simple idea for partitioning the graph in two traverses enough levels to visit about half of all the nodes. The visited nodes will be assigned to one subdomain and the others will constitute the second subdomain. The process can then be repeated recursively on each of the subdomains. A key ingredient for this technique to be successful is to determine a good initial node from which to start the traversal. Often, a heuristic is used for this purpose. Recall that $d(x, y)$ is the distance between vertices x and y in the graph, i.e., the length of the shortest path between x and y . If the diameter of a graph is defined as

$$\delta(G) = \max\{d(x, y) \mid x \in V, y \in V\}$$

then, ideally, one of two nodes in a pair (x, y) that achieves the diameter can be used as a starting node. These *peripheral nodes*, are expensive to determine. Instead, a *pseudo-peripheral node*, as defined through the following procedure, is often employed.

ALGORITHM 13.8: Pseudo-Peripheral Node

1. Select an initial node x . Set $\delta = 0$.
 2. Do a level set traversal from x
 3. Select a node y in the last level set, with minimum degree
 4. If $d(x, y) > \delta$ then
 5. Set $x := y$ and $\delta := d(x, y)$
 6. GoTo 2
 7. Else Stop: x is a pseudo-peripheral node.
 8. EndIf
-

The distance $d(x, y)$ in line 5 is the number of levels in the level set traversal needed in Step 2. The algorithm traverses the graph from a node of the last level in the previous traversal, until the number of levels stabilizes. It is easy to see that the algorithm does indeed stop after a finite number of steps, typically small.

The above algorithm plays a key role in sparse matrix computations. It is very helpful in the context of graph partitioning as well. A first heuristic approach based on level set traversals is the recursive dissection procedure mentioned above and described next.

ALGORITHM 13.9: Recursive Graph Bisection

1. Set $G_* := G$, $S := \{G\}$, $n_{dom} := 1$
 2. While $n_{dom} < s$ Do:
 3. Select in S the subgraph G_* with largest size.
 4. Find a pseudo-peripheral node p in G_* and
 5. Do a level set traversal from p . Let $lev :=$ number of levels.
 6. Let G_1 the subgraph of G_* consisting of the first $lev/2$
 7. levels, and G_2 the subgraph containing the rest of G_* .
 8. Remove G_* from S and add G_1 and G_2 to it
 9. $n_{dom} := n_{dom} + 1$
 10. EndWhile
-

The cost of this algorithm is rather small. Each traversal of a graph $G = (V, E)$ costs around $|E|$, where $|E|$ is the number of edges (assuming that $|V| = O(|E|)$). Since there are s traversals of graphs whose size decreases by 2 at each step, it is clear that the cost is $O(|E|)$, the order of edges in the original graph.

As can be expected, the results of such an algorithm are not always good. Typically, two qualities that are measured are the sizes of the domains as well as the number of cut-edges. Ideally, the domains should be equal. In addition, since the values at the interface points should be exchanged with those of neighboring processors, their total number, as determined by the number of cut-edges, should be as small as possible. The first measure can be easily controlled in a recursive Graph Bisection Algorithm — for example, by using variants in which the number of nodes is forced to be exactly half that of the original subdomain. The second measure is more difficult to control. Thus, the top part of Figure 13.9 shows the result of the RGB algorithm on a sample finite-element mesh. This is a vertex-based partitioning. The dashed lines are the cut-edges that link two different domains.

An approach that is competitive with the one described above is that of *double striping*. This method uses two parameters p_1, p_2 such that $p_1 p_2 = s$. The original graph is first partitioned into p_1 large partitions, using one-way partitioning, then each of these partitions is subdivided into p_2 partitions similarly. One-way partitioning into p subgraphs consists of performing a level set traversal from a pseudo-peripheral node and assigning each set of roughly n/p consecutive nodes in the traversal to a different subgraph. The result of this approach with $p_1 = p_2 = 4$ is shown in Figure 13.9 on the same graph as before. As can be observed, the subregions obtained by both methods have elongated and twisted shapes. This has the effect of giving a larger number of cut-edges.

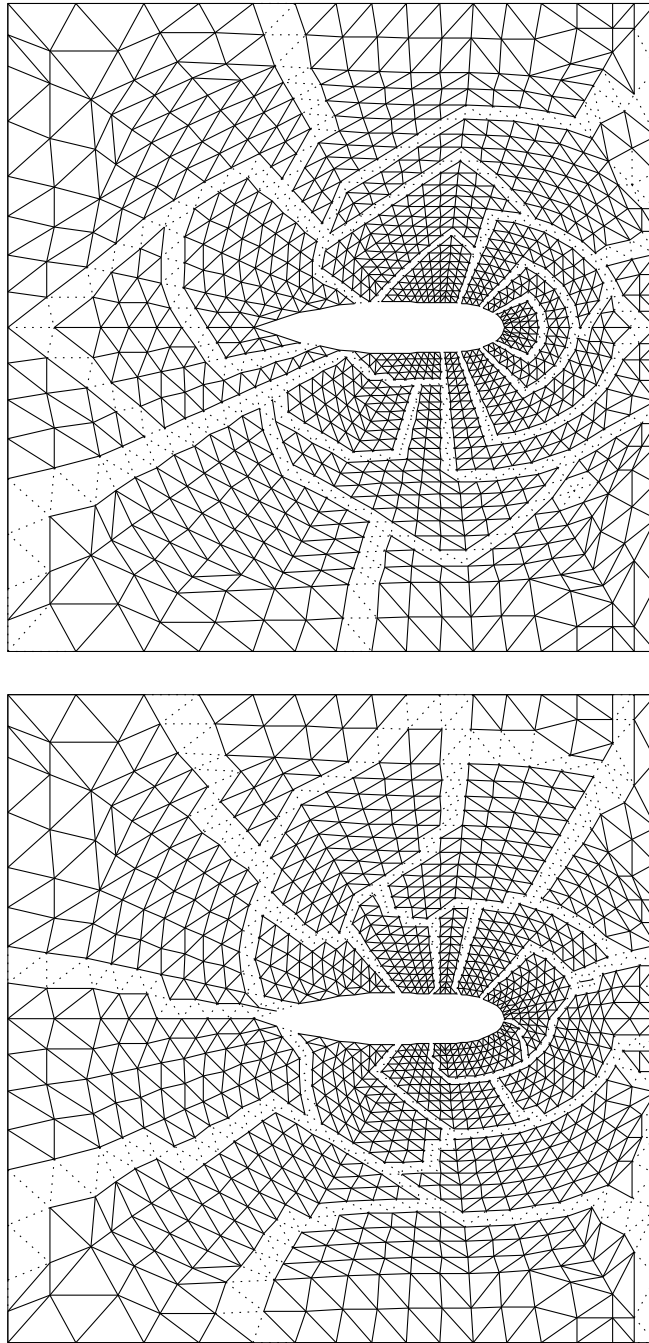

Figure 13.9 *The RGB algorithm (top) and the double-striping algorithm (bottom) for partitioning a graph into 16 subgraphs.*

There are a number of heuristic ways to remedy this. One strategy is based on the fact that a level set traversal from k nodes can be defined instead of only one node. These k nodes are called the *centers* or *sites*. Each subdomain will expand from one of these k centers and the expansion will stop when it is no longer possible to acquire another point that is not already assigned. The boundaries of each domain that are formed this way will tend to be more “circular.” To smooth the boundaries of an initial partition, find some center point of each domain and perform a level set expansion from the set of points. The process can be repeated a few times.

ALGORITHM 13.10: Multinode Level-Set Expansion Algorithm

1. Find a partition $S = \{G_1, G_2, \dots, G_s\}$.
2. For $iter = 1, \dots, nouter$ Do:
3. For $k = 1, \dots, s$ Do:
4. Find a center c_k of G_k . Set $label(c_k) = k$.
5. EndDo
6. Do a level set traversal from $\{c_1, c_2, \dots, c_s\}$. Label each child
7. in the traversal with the same label as its parent.
8. For $k = 1, \dots, s$ set $G_k :=$ subgraph of all nodes having label k
9. EndDo

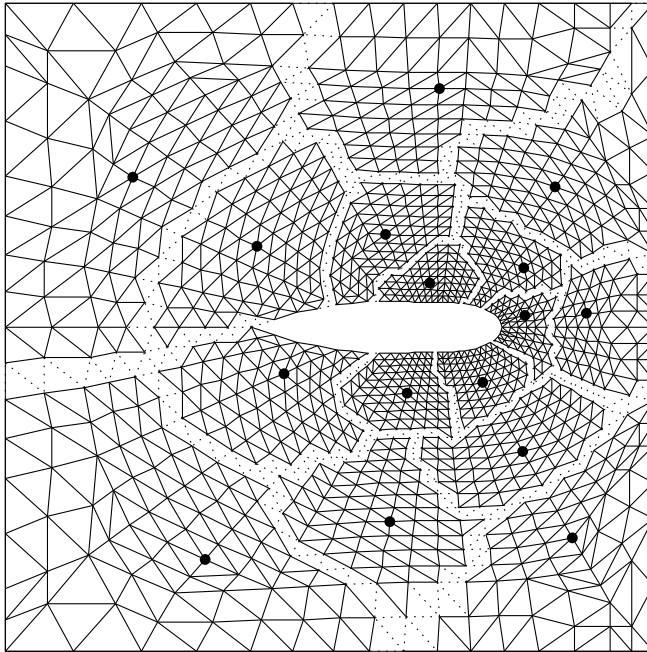

Figure 13.10 Multinode expansion starting with the partition obtained in Figure 13.9.

For this method, a total number of cut-edges equal to 548 and a rather small standard deviation of 0.5 are obtained for the example seen earlier.

Still to be decided is how to select the center nodes mentioned in line 4 of the algorithm. Once more, the pseudo-peripheral algorithm will be helpful. Find a pseudo-peripheral node, then do a traversal from it until about one-half of the nodes have been traversed. Then, traverse the latest level set (typically a line or a very narrow graph), and take the middle point as the center.

A typical number of outer steps, *nouter*, to be used in line 2, is less than five. This heuristic works well in spite of its simplicity. For example, if this is applied to the graph obtained from the RGB algorithm, with *nouter* = 3, the partition shown in Figure 13.10 is obtained. With this technique, the resulting total number of cut-edges is equal to 441 and the standard deviation is 7.04. As is somewhat expected, the number of cut-edges has decreased dramatically, while the standard deviation of the various sizes has increased.

EXERCISES

1. In the proof of Theorem 13.4, the following form of the Cauchy-Schwarz inequality was used:

$$\sum_{i=1}^p (x_i, y_i) \leq \left(\sum_{i=1}^p (x_i, x_i) \right)^{1/2} \left(\sum_{i=1}^p (y_i, y_i) \right)^{1/2}.$$

- (a) Prove that this result is a consequence of the standard Cauchy-Schwarz inequality. (b) Extend the result to the A -inner product. (c) Assume that the x_i 's and y_i 's are the columns of two $n \times p$ matrix X and Y . Rewrite the result in terms of these matrices.
2. Using Lemma 13.1, write explicitly the vector $M^{-1}b$ for the Multiplicative Schwarz procedure, in terms of the matrix A and the R_i 's, when $s = 2$, and then when $s = 3$.
3. (a) Show that in the multiplicative Schwarz procedure, the residual vectors $r_i = b - Ax_i$ obtained at each step satisfy the recurrence,

$$r_i = r_{i-1} - AR_i^T A_i^{-1} R_i r_{i-1}$$

for $i = 1, \dots, s$. (b) Consider the operator $Q_i \equiv AR_i^T A_i^{-1} R_i$. Show that Q_i is a projector. (c) Is Q_i an orthogonal projector with respect to the A -inner product? With respect to which inner product is it orthogonal?

4. The analysis of the Additive Schwarz procedure assumes that A_i^{-1} is "exact," i.e., that linear systems $A_i x = b$ are solved exactly, each time A_i^{-1} is applied. Assume that A_i^{-1} is replaced by some approximation Θ_i^{-1} . (a) Is P_i still a projector? (b) Show that if Θ_i is Symmetric Positive Definite, then so is P_i . (c) Now make the assumption that $\lambda_{\max}(P_i) \leq \omega_*$. What becomes of the result of Theorem 13.2?
5. In Element-By-Element (EBE) methods, the extreme cases of the Additive or the Multiplicative Schwarz procedures are considered in which the subdomain partition corresponds to taking Ω_i to be an element. The advantage here is that the matrices do not have to be assembled. Instead, they are kept in unassembled form (see Chapter 2). Assume that Poisson's equation is being solved.

(a) What are the matrices A_i ? (b) Are they SPD? (c) Write down the EBE preconditioning corresponding to the multiplicative Schwarz procedure, its multicolor version, and the additive Schwarz procedure.

6. Theorem 13.1 was stated only for the multiplicative version of the Schwarz procedure. There is a similar result for the additive Schwarz procedure. State this result and prove it.
7. Show that the matrix defined by (13.37) is indeed a projector. Is it possible to formulate Schwarz procedures in terms of projection processes as seen in Chapter 5?
8. It was stated at the end of the proof of Theorem 13.4 that if

$$(A_J u, u)_A \geq \frac{1}{C} (u, u)_A$$

for any nonzero u , then $\lambda_{\min}(A_J) \geq \frac{1}{C}$. (a) Prove this result without invoking the min-max theory. (b) Prove a version of the min-max theorem with the A -inner product, i.e., prove that the min-max theorem is valid for any inner product for which A is self-adjoint.

9. Consider the Laplacean of a graph as defined in Section 13.6. Show that

$$(Lx, x) = \sum_{(i,j) \in E} (x_i - x_j)^2.$$

10. Consider a rectangular finite difference mesh, with mesh size $\Delta x = h$ in the x -direction and $\Delta y = h$ closest to the y -direction.
- a. To each mesh point $p = (x_i, y_j)$, associate the closed disk D_{ij} of radius h centered at p_i . What is the smallest k such that the family $\{D_{ij}\}$ is a k -ply system?
- b. Answer the same question for the case where the radius is reduced to $h/2$. What is the overlap graph (and associated mesh) for any α such that

$$\frac{1}{2} < \alpha < \frac{\sqrt{2}}{2} ?$$

What about when $\alpha = 2$?

11. Determine the cost of a level set expansion algorithm starting from p distinct centers.
12. Write a FORTRAN subroutine (or C function) which implements the Recursive Graph Partitioning algorithm.
13. Write recursive versions of the Recursive Graph Partitioning algorithm and Recursive Spectral Bisection algorithm. [Hint: Recall that a recursive program unit is a subprogram or function, say *foo*, which calls itself, so *foo* is allowed to make a subroutine call to *foo* within its body. Recursivity is not allowed in FORTRAN but is possible in C or C++.] (a) Give a pseudo-code for the RGB algorithm which processes the subgraphs in any order. (b) Give a pseudo-code for the RGB algorithm case when the larger subgraph is to be processed before the smaller one in any dissection. Is this second version equivalent to Algorithm 13.9?

NOTES AND REFERENCES. To start with, the original paper by Schwarz is the reference [193], but an earlier note appeared in 1870. In recent years, research on Domain Decomposition techniques has been very active and productive. This rebirth of an old technique has been in large part motivated by parallel processing. However, the first practical use of Domain Decomposition ideas has been in applications to very large structures; see [166, 29], and elasticity problems; see, e.g., [169, 205, 198, 51, 28] for references.

Two recent monographs that describe the use of Domain Decomposition approaches in structural mechanics are [143] and [87]. Recent survey papers include those by Keyes and Gropp [135] and another by Chan and Matthew [50]. The recent volume [136] discusses the various uses of “domain-based” parallelism in computational sciences and engineering.

The bulk of recent work on Domain Decomposition methods has been geared toward a Partial Differential Equations viewpoint. Often, there appears to be a dichotomy between this viewpoint and that of “applied Domain Decomposition,” in that the good methods from a theoretical point of view are hard to implement in practice. The Schwarz multiplicative procedure, with multicoloring, represents a compromise between good intrinsic properties and ease of implementation. For example, Venkatakrisnan concludes in [215] that although the use of global coarse meshes may accelerate convergence of local, domain-based, ILU preconditioners, it does not necessarily reduce the overall time to solve a practical aerodynamics problem.

Much is known about the convergence of the Schwarz procedure; refer to the work by Widlund and co-authors [30, 72, 73, 74, 46]. The convergence results of Section 13.3.4 have been adapted from Xu [230] as well as Hackbusch [116]. The result on the equivalence between Schwarz and Schur complement iterations stated in Theorem 13.1 seems to have been originally proved by Chan and Goovaerts [48]. The results on the equivalence between the full matrix techniques and the Schur matrix techniques seen in Section 13.5 have been adapted from results by S. E. Eisenstat, reported in [135]. These connections are rather interesting and useful in practice since they provide some flexibility on ways to implement a method. A number of preconditioners have also been derived using these connections in the PDE framework [32, 31, 33, 34, 35].

Research on graph partitioning is currently very active. So far, variations of the Recursive Spectral Bisection algorithm [165] seem to give the best results in terms of overall quality of the subgraphs. However, the algorithm is rather expensive, and less costly multilevel variations have been developed [119]. Alternatives of the same class as those presented in Section 13.6.4 may be quite attractive for a number of reasons, including cost, ease of implementation, and flexibility; see [107]. There is a parallel between the techniques based on level set expansions and the ideas behind Voronoi diagrams known in computational geometry. The description of the geometric partitioning techniques in Section 13.6.2 is based on the recent papers [105] and [150]. Earlier approaches have been developed in [55, 56, 57]. ■



REFERENCES

1. J. Abaffy and E. Spedicato. *ABS Projection Methods*. Halstead Press, 1989.
2. L. M. Adams. *Iterative algorithms for large sparse linear systems on parallel computers*. Ph.D. thesis, Applied Mathematics, University of Virginia, Charlottesville, VA, 1982. Also NASA Contractor Report 166027.
3. L. M. Adams and H. Jordan. Is SOR color-blind? *SIAM Journal on Scientific and Statistical Computing*, 6:490–506, 1985.
4. L. M. Adams and J. Ortega. A multi-color SOR Method for Parallel Computers. In *Proceedings of the 1982 International Conference on Pararallel Processing*, pages 53–56, 1982.
5. J. I. Aliaga, D. L. Boley, R. W. Freund, and V. Hernández. A Lanczos-type algorithm for multiple starting vectors. Technical Report Numerical Analysis Manuscript No 95-11, AT&T Bell Laboratories, Murray Hill, NJ, 1995.
6. F. L. Alvarado. Manipulation and visualization of sparse matrices. *ORSA Journal on Computing*, 2:186–206, 1990.
7. E. C. Anderson. Parallel implementation of preconditioned conjugate gradient methods for solving sparse systems of linear equations. Technical Report 805, CSRD, University of Illinois, Urbana, IL, 1988. MS Thesis.
8. E. C. Anderson and Y. Saad. Solving sparse triangular systems on parallel computers. *International Journal of High Speed Computing*, 1:73–96, 1989.
9. W. E. Arnoldi. The principle of minimized iteration in the solution of the matrix eigenvalue problem. *Quart. Appl. Math.*, 9:17–29, 1951.
10. C. C. Ashcraft and R. G. Grimes. On vectorizing incomplete factorization and SSOR preconditioners. *SIAM Journal on Scientific and Statistical Computing*, 9:122–151, 1988.
11. O. Axelsson. A generalized SSOR method. *BIT*, 12:443–467, 1972.
12. O. Axelsson. Conjugate gradient type-methods for unsymmetric and inconsistent systems of linear equations. Technical Report 74-10, CERN, Geneva, 1974.
13. O. Axelsson. Conjugate gradient type-methods for unsymmetric and inconsistent systems of linear equations. *Linear Algebra and its Applications*, 29:1–16, 1980.
14. O. Axelsson. A generalized conjugate gradient, least squares method. *Numerische Mathematik*, 51:209–227, 1987.

15. O. Axelsson. *Iterative Solution Methods*. Cambridge University Press, New York, 1994.
16. O. Axelsson and V. A. Barker. *Finite Element Solution of Boundary Value Problems*. Academic Press, Orlando, FL, 1984.
17. O. Axelsson, S. Brinkkemper, and V. P. Ill'in. On some versions of incomplete block-matrix factorization iterative methods. *Linear Algebra and its Applications*, 58:3–15, 1984.
18. O. Axelsson and P. S. Vassilevski. A block generalized conjugate gradient solver with inner iterations and variable step preconditioning. *SIAM Journal on Matrix Analysis and Applications*, 12, 1991.
19. S. Balay, W. D. Gropp, L. Curfman McInnes, and B. F. Smith. PETSc 2.0 users manual. Technical Report ANL-95/11 - Revision 2.0.24, Argonne National Laboratory, 1999.
20. R. E. Bank and T. F. Chan. An analysis of the composite step biconjugate gradient method. *Numerische Mathematik*, 66:259–319, 1993.
21. T. Barth and T. Manteuffel. Variable metric conjugate gradient methods. In *Advances in Numerical Methods for Large Sparse Sets of Linear Equations, Number 10, Matrix Analysis and Parallel Computing, PCG 94*, pages 165–188. Keio University, Yokohama, Japan, 1994.
22. D. Baxter, J. Saltz, M. H. Schultz, S. C. Eisenstat, and K. Crowley. An experimental study of methods for parallel preconditioned Krylov methods. In *Proceedings of the 1988 Hypercube Multiprocessors Conference*, pages 1698–1711. Pasadena, CA, Jan. 1988.
23. M. Benantar and J. E. Flaherty. A six color procedure for the parallel solution of Elliptic systems using the finite quadtree structure. In J. Dongarra, P. Messina, D. C. Sorenson, and R. G. Voigt, editors, *Proceedings of the Fourth SIAM Conference on Parallel Processing for Scientific Computing*, pages 230–236, 1990.
24. H. Berryman, J. Saltz, W. Gropp, and R. Mirchandaney. Krylov methods preconditioned with incompletely factored matrices on the CM-2. *Journal of Parallel and Distributed Computing*, 8:186–190, 1990.
25. D. P. Bertsekas and J. Tsitsiklis. *Parallel and Distributed Computation*. Prentice Hall, Englewood Cliffs, NJ, 1989.
26. G. Birkhoff, R. Varga, S R., and D. Young. Alternating direction implicit methods. In *Advances in Computers*, pages 189–273. Academic Press, New York, 1962.
27. A. Björck and T. Elfving. Accelerated projection methods for computing pseudo-inverse solutions of systems of linear equations. *BIT*, 19:145–163, 1979.
28. P. E. Bjørstad and Anders Hvidsten. Iterative methods for substructured elasticity problems in structural analysis. In Roland Glowinski, Gene H. Golub, Gérard A. Meurant, and Jacques Périaux, editors, *Domain Decomposition Methods for Partial Differential Equations*. SIAM, Philadelphia, PA, 1988.
29. P. E. Bjørstad and O. B. Widlund. Solving elliptic problems on regions partitioned into substructures. In Garrett Birkhoff and Arthur Schoenstadt, editors, *Elliptic Problem Solvers II*, pages 245–256. Academic Press, New York, NY, 1984.

30. P. E. Bjørstad and O. B. Widlund. Iterative methods for the solution of elliptic problems on regions partitioned into substructures. *SIAM Journal on Numerical Analysis*, 23(6):1093–1120, 1986.
31. J. H. Bramble, J. E. Pasciak, and A. H. Schatz. The construction of preconditioners for elliptic problems by substructuring, I. *Mathematics of Computations*, 47(175):103–134, 1986.
32. J. H. Bramble, J. E. Pasciak, and A. H. Schatz. An iterative method for elliptic problems on regions partitioned into substructures. *Mathematics of Computations*, 46(173):361–369, 1986.
33. J. H. Bramble, J. E. Pasciak, and A. H. Schatz. The construction of preconditioners for elliptic problems by substructuring, II. *Mathematics of Computations*, 49:1–16, 1987.
34. J. H. Bramble, J. E. Pasciak, and A. H. Schatz. The construction of preconditioners for elliptic problems by substructuring, III. *Mathematics of Computations*, 51:415–430, 1988.
35. J. H. Bramble, J. E. Pasciak, and A. H. Schatz. The construction of preconditioners for elliptic problems by substructuring, IV. *Mathematics of Computations*, 53:1–24, 1989.
36. R. Bramley and A. Sameh. Row projection methods for large nonsymmetric linear systems. *SIAM Journal on Scientific and Statistical Computing*, 13:168–193, 1992.
37. R. Bramley and A. Sameh. A robust parallel solver for block tridiagonal systems. In *Proceedings of the International Conference on Supercomputing*, pages 39–54. ACM, July 1988.
38. C. Brezinski. *Padé Type Approximation and General Orthogonal Polynomials*. Birkhäuser-Verlag, Basel-Boston-Stuttgart, 1980.
39. C. Brezinski and M. Redivo Zaglia. *Extrapolation Methods: Theory and Practice*. North-Holland, Amsterdam, 1991.
40. C. Brezinski and M. Redivo-Zaglia. Hybrid procedures for solving systems of linear equations. *Numerische Mathematik*, 67:1–19, 1994.
41. C. Brezinski, M. Redivo-Zaglia, and H. Sadok. Avoiding breakdown and near-breakdown in Lanczos-type algorithms. *Numerical Algorithms*, 1:261–284, 1991.
42. C. Brezinski, M. Redivo-Zaglia, and H. Sadok. A breakdown-free Lanczos-type algorithm for solving linear systems. *Numerische Mathematik*, 63:29–38, 1992.
43. P. N. Brown. A theoretical comparison of the Arnoldi and GMRES algorithms. *SIAM Journal on Scientific and Statistical Computing*, 12:58–78, 1991.
44. P. N. Brown and A. C. Hindmarsh. Matrix-free methods for stiff systems of ODEs. *SIAM Journal on Numerical Analysis*, 23:610–638, 1986.
45. N. I. Buleev. A numerical method for the solution of two-dimensional and three-dimensional equations of diffusion. *Math. Sb*, 51:227–238, 1960. (in Russian).
46. X. C. Cai and O. Widlund. Multiplicative Schwarz algorithms for some nonsymmetric and indefinite problems. *SIAM Journal on Numerical Analysis*, 30(4), August 1993.

47. T. F. Chan, E. Gallopoulos, V. Simoncini, T. Szeto, and C.H. Tong. A quasi-minimal residual variant of the Bi-CGSTAB algorithm for nonsymmetric systems. *SIAM Journal on Scientific Computing*, 15(2):338–347, 1994.
48. T. F. Chan and D. Goovaerts. On the relationship between overlapping and nonoverlapping domain decomposition methods. *SIAM Journal on Matrix Analysis and Applications*, 13:663–670, 1992.
49. T. F. Chan and T. P. Mathew. The interface probing technique in domain decomposition. *SIAM Journal on Matrix Analysis and Applications*, 13(1):212–238, 1992.
50. T. F. Chan and T. P. Mathew. Domain decomposition algorithms. *Acta Numerica*, pages 61–143, 1994.
51. H. C. Chen and A. Sameh. A matrix decomposition method for orthotropic elasticity problems. *SIAM Journal on Matrix Analysis and Applications*, 10(1):39–64, 1989.
52. C. C. Cheney. *Introduction to Approximation Theory*. McGraw Hill, NY, 1966.
53. E. Chow and Y. Saad. ILUS: an incomplete LU factorization for matrices in sparse skyline format. *International Journal for Numerical Methods in Fluids*, 25:739–748, 1997.
54. E. Chow and Y. Saad. Approximate inverse preconditioners via sparse-sparse iterations. *SIAM Journal on Scientific Computing*, 19:995–1023, 1998.
55. N. Chrisochoides, Geoffrey Fox, and Joe Thompson. MENUS-PGG mapping environment for numerical unstructured and structured parallel grid generation. In *Proceedings of the Seventh International Conference on Domain Decomposition Methods in Scientific and Engineering Computing*, 1993.
56. N. Chrisochoides, C. E. Houstis, E. N. Houstis, P. N. Papachiou, S. K. Kortesis, and J. Rice. DOMAIN DECOMPOSER: a software tool for mapping PDE computations to parallel architectures. In R. Glowinski et. al., editor, *Domain Decomposition Methods for Partial Differential Equations*, pages 341–357. SIAM publications, 1991.
57. N. Chrisochoides, E. Houstis, and J. Rice. Mapping algorithms and software environment for data parallel PDE iterative solvers. *Journal of Parallel and Distributed Computing*, 21:75–95, 1994.
58. G. Cimmino. Calcolo approssimato per le soluzioni dei sistemi di equazioni lineari. *Ric. Sci. Progr. tecn. econom. naz.*, 9:326–333, 1938.
59. A. Clayton. Further results on polynomials having least maximum modulus over an ellipse in the complex plane. Technical Report AEEW-7348, UKAEA, Harewell-UK, 1963.
60. P. Concus and G. H. Golub. A generalized conjugate gradient method for nonsymmetric systems of linear equations. In R. Glowinski and J. L. Lions, editors, *Computing Methods in Applied Sciences and Engineering*, pages 56–65. Springer Verlag, New York, 1976.
61. P. Concus, G. H. Golub, and G. Meurant. Block preconditioning for the conjugate gradient method. *SIAM Journal on Scientific and Statistical Computing*, 6:220–252, 1985.

62. J. D. F. Cosgrove, J. C. Diaz, and A. Griewank. Approximate inverse preconditioning for sparse linear systems. *International Journal of Computational Mathematics*, 44:91–110, 1992.
63. J. Cullum and Anne Greenbaum. Residual relationships within three pairs of iterative algorithms for solving $Ax=b$. Technical Report IBM Research Report RC 18672, IBM T. J. Watson Research Center, Yorktown Heights, New York, January 1993. To appear, *SIAM Journal of Matrix Analysis and Applications*, 1996.
64. B. N. Datta. *Numerical Linear Algebra and Applications*. Brooks/Cole Publishing, Pacific Grove, CA, 1995.
65. P. J. Davis. *Interpolation and Approximation*. Blaisdell, Waltham, MA, 1963.
66. T. A. Davis. *A parallel algorithm for sparse unsymmetric LU factorizations*. Ph.D. thesis, University of Illinois at Urbana Champaign, Urbana, IL., 1989.
67. E. F. D’Azevedo, F. A. Forsyth, and W. P. Tang. Ordering methods for preconditioned conjugate gradient methods applied to unstructured grid problems. *SIAM Journal on Matrix Analysis and Applications*, 13:944–961, 1992.
68. E. F. D’Azevedo, F. A. Forsyth, and W. P. Tang. Towards a cost effective ILU preconditioner with high level fill. *BIT*, 31:442–463, 1992.
69. M. A. DeLong and J. M. Ortega. SOR as a preconditioner. *Applied Numerical Mathematics*, 18:431–440, 1995.
70. P. Deuffhard, R. W. Freund, and A. Walter. Fast secant methods for the iterative solution of large nonsymmetric linear systems. *IMPACT of Computing in Science and Engineering*, 2:244–276, 1990.
71. J. J. Dongarra, I. S. Duff, D. Sorensen, and H. A. van der Vorst. *Solving Linear Systems on Vector and Shared Memory Computers*. SIAM, Philadelphia, PA, 1991.
72. M. Dryja and O. B. Widlund. Some domain decomposition algorithms for elliptic problems. In Linda Hayes and David Kincaid, editors, *Iterative Methods for Large Linear Systems*, pages 273–291. Academic Press, New York, NY, 1989.
73. M. Dryja and O. B. Widlund. Towards a unified theory of domain decomposition algorithms for elliptic problems. In Tony Chan, Roland Glowinski, Jacques Périaux, and O. Widlund, editors, *Third International Symposium on Domain Decomposition Methods for Partial Differential Equations, held in Houston, TX, March 20-22, 1989*. SIAM, Philadelphia, PA, 1990.
74. M. Dryja and O. B. Widlund. Additive Schwarz methods for elliptic finite element problems in three dimensions. In T. F. Chan, David E. Keyes, Gérard A. Meurant, Jeffrey S. Scroggs, and Robert G. Voigt, editors, *Fifth International Symposium on Domain Decomposition Methods for Partial Differential Equations*. SIAM, Philadelphia, PA, 1992.
75. P. F. Dubois, A. Greenbaum, and G. H. Rodrigue. Approximating the inverse of a matrix for use on iterative algorithms on vector processors. *Computing*, 22:257–268, 1979.
76. I. S. Duff. A survey of sparse matrix research. In *Proceedings of the IEEE*, 65, pages 500–535. Prentice Hall, New York, 1977.
77. I. S. Duff, A. M. Erisman, and J. K. Reid. *Direct Methods for Sparse Matrices*. Clarendon Press, Oxford, 1986.

78. I. S. Duff, R. G. Grimes, and J. G. Lewis. Sparse matrix test problems. *ACM Transactions on Mathematical Software*, 15:1–14, 1989.
79. T. Eirola and O. Nevanlinna. Accelerating with rank-one updates. *Linear Algebra and its Applications*, 121:511–520, 1989.
80. S. Eisenstat. Efficient implementation of a class of conjugate gradient methods. *SIAM Journal on Scientific and Statistical Computing*, 2:1–4, 1988.
81. H. C. Elman. A stability analysis of incomplete LU factorizations. *Mathematics of Computations*, 47:191–217, 1986.
82. H. C. Elman and E. Agron. Ordering techniques for the preconditioned conjugate gradient method on parallel computers. *Computer Physics Communications*, 53:253–269, 1989.
83. H. C. Elman and G. H. Golub. Iterative methods for cyclically reduced non-self-adjoint linear systems. *Mathematics of Computations*, 54:671–700, 1990.
84. M. Engleman. FIDAP manuals. Technical Report Vol. 1, 2, and 3, Fluid Dynamics International, Evanston, IL, 1986.
85. V. Faber and T. Manteuffel. Necessary and sufficient conditions for the existence of a conjugate gradient method. *SIAM Journal on Numerical Analysis*, 21:352–361, 1984.
86. Ky Fan. Note on M -matrices. *Quarterly Journal of Mathematics, Oxford series (2)*, 11:43–49, 1960.
87. C. Farhat and J. X. Roux. Implicit parallel processing in structural mechanics. *Computational Mechanics Advances*, 2(1):1–124, 1994.
88. R. M. Ferencz. *Element-by-element preconditioning techniques for large scale vectorized finite element analysis in nonlinear solid and structural mechanics*. Ph.D. thesis, Department of Applied Mathematics, Stanford, CA, 1989.
89. B. Fischer and R. W. Freund. On the constrained Chebyshev approximation problem on ellipses. *Journal of Approximation Theory*, 62:297–315, 1990.
90. B. Fischer and R. W. Freund. Chebyshev polynomials are not always optimal. *Journal of Approximation Theory*, 65:261–272, 1991.
91. B. Fischer and L. Reichel. A stable Richardson iteration method for complex linear systems. *Numerische Mathematik*, 54:225–241, 1988.
92. R. Fletcher. Conjugate gradient methods for indefinite systems. In G. A. Watson, editor, *Proceedings of the Dundee Biennial Conference on Numerical Analysis 1974*, pages 73–89. Springer Verlag, New York, 1975.
93. R. W. Freund. Conjugate gradient-type methods for linear systems with complex symmetric coefficient matrices. *SIAM Journal on Scientific and Statistical Computing*, 13:425–448, 1992.
94. R. W. Freund. Quasi-kernel polynomials and convergence results for quasi-minimal residual iterations. In Dietrich Braess and Larry L. Schumaker, editors, *Numerical Methods of Approximation Theory, Vol 9*, International series of numerical mathematics, pages 1–19. Birkhäuser Verlag, Basel, 1992.

95. R. W. Freund. A Transpose-Free Quasi-Minimal Residual algorithm for non-Hermitian linear systems. *SIAM Journal on Scientific Computing*, 14(2):470–482, 1993.
96. R. W. Freund, M. H. Gutknecht, and N. M. Nachtigal. An implementation of the Look-Ahead Lanczos algorithm. *SIAM Journal on Scientific and Statistical Computing*, 14(2):470–482, 1993.
97. R. W. Freund and N. M. Nachtigal. QMR: a quasi-minimal residual method for non-Hermitian linear systems. *Numerische Mathematik*, 60:315–339, 1991.
98. K. Gallivan, A. Sameh, and Z. Zlatev. A parallel hybrid sparse linear system solver. *Computing Systems in Engineering*, 1(2-4):183–195, June 1990.
99. K. A. Gallivan, M. T. Heath, E. Ng, J. M. Ortega, R. J. Plemmons, C. H. Romine, A. H. Sameh, and R. G. Voigt. *Parallel Algorithms for Matrix Computations*. SIAM, Philadelphia, 1990.
100. F. R. Gantmacher. *The Theory of Matrices*. Chelsea, New York, 1959.
101. N. Gastinel. *Analyse Numérique Linéaire*. Hermann, Paris, 1966.
102. W. Gautschi. On generating orthogonal polynomials. *SIAM Journal on Scientific and Statistical Computing*, 3:289–317, 1982.
103. A. George. Computer implementation of the finite element method. Technical Report STAN-CS-208, Stanford University, Department of Computer Science, 1971.
104. J. A. George and J. W. Liu. *Computer Solution of Large Sparse Positive Definite Systems*. Prentice-Hall, Englewood Cliffs, NJ, 1981.
105. J. R. Gilbert, G. L. Miller, and S.-H. Teng. Geometric mesh partitioning: Implementation and experiments. In *IPPS 94, Submitted to SIAM SISC*, 1995.
106. S. K. Godunov and G. P. Propkopov. A method of minimal iteration for evaluating the eigenvalues of an elliptic operator. *Zh. Vychsl. Mat. Mat. Fiz.*, 10:1180–1190, 1970.
107. T. Goehring and Y. Saad. Heuristic algorithms for automatic graph partitioning. Technical Report umsi-94-29, University of Minnesota Supercomputer Institute, Minneapolis, MN, February 1994.
108. G. H. Golub and 3rd edn C. Van Loan. *Matrix Computations*. The John Hopkins University Press, Baltimore, 1996.
109. G. H. Golub and M. L. Overton. The convergence of inexact Chebyshev and Richardson iterative methods for solving linear systems. *Numerische Mathematik*, 53:571–593, 1988.
110. G. H. Golub and R. S. Varga. Chebyshev semi iterative methods successive overrelaxation iterative methods and second order Richardson iterative methods. *Numerische Mathematik*, 3:147–168, 1961.
111. A. Greenbaum, C. Li, and H. Z. Chao. Parallelizing preconditioned conjugate gradient algorithms. *Computer Physics Communications*, 53:295–309, 1989.
112. M. Grote and H. D. Simon. Parallel preconditioning and approximate inverses on the connection machine. In R. F. Sincovec, D. E. Keyes, L. R. Petzold, and D. A. Reed, editors, *Parallel Processing for Scientific Computing – vol. 2*, pages 519–523. SIAM, 1992.

113. M. H. Gutknecht. A completed theory of the unsymmetric Lanczos process and related algorithms. Part I. *SIAM Journal on Matrix Analysis and Applications*, 13:594–639, 1992.
114. M. H. Gutknecht. A completed theory of the unsymmetric Lanczos process and related algorithms. Part II. *SIAM Journal on Matrix Analysis and Applications*, 15:15–58, 1994.
115. W. Hackbusch. *Multi-Grid Methods and Applications*. Springer Verlag, New York, 1985.
116. W. Hackbusch. *Iterative Solution of Large Linear Systems of Equations*. Springer Verlag, New York, 1994.
117. P. R. Halmos. *Finite-Dimensional Vector Spaces*. Springer Verlag, New York, 1958.
118. S. Hammond and R. Schreiber. Efficient iccg on a shared memory multiprocessor. Technical Report 89. 24, RIACS, NASA Ames research center, Moffett Field CA., 1989.
119. B. Hendrickson and R. Leland. An improved spectral graph partitioning algorithm for mapping parallel computations. Technical Report SAND92-1460, UC-405, Sandia National Laboratories, Albuquerque, NM, 1992.
120. M. R. Hestenes and E. L. Stiefel. Methods of conjugate gradients for solving linear systems. *Journal of Research of the National Bureau of Standards, Section B*, 49:409–436, 1952.
121. C. Hirsch. *Numerical Computation of Internal and External Flows*. John Wiley and Sons, New York, 1988.
122. A. S. Householder. *Theory of Matrices in Numerical Analysis*. Blaisdell Pub. Co., Johnson, CO, 1964.
123. T. J. R. Hughes, R. M. Ferencz, and J. O. Hallquist. Large-scale vectorized implicit calculations in solid mechanics on a Cray X-MP/48 utilizing EBE preconditioned conjugate gradients. *Computer Methods in Applied Mechanics and Engineering*, 61:215–248, 1987.
124. K. Hwang. *Advanced Computer Architecture with Parallel Programming*. Mc Graw Hill, New York, 1993.
125. K. Jbilou. Projection minimization methods for nonsymmetric linear systems. To appear, *Linear Algebra and its Applications*.
126. K. Jbilou and H. Sadok. Analysis of some vector extrapolation methods for solving systems of linear equations. *Numerische Mathematik*, pages 73–89, 1995.
127. K. C. Jea and D. M. Young. Generalized conjugate gradient acceleration of nonsymmetrizable iterative methods. *Linear Algebra and its Applications*, 34:159–194, 1980.
128. C. Johnson. *Numerical Solutions of Partial Differential Equations by the Finite Element Method*. Cambridge University Press, Cambridge, UK, 1987.
129. O. G. Johnson, C. A. Micchelli, and G. Paul. Polynomial preconditionings for conjugate gradient calculations. *SIAM Journal on Numerical Analysis*, 20:362–376, 1983.

130. S. Kaczmarz. Angenäherte auflösung von systemen linearer gleichungen. *Bulletin international de l'Académie polonaise des Sciences et Lettres*, pages 355–357, 1937.
131. C. Kamath and A. Sameh. A projection method for solving nonsymmetric linear systems on multiprocessors. *Parallel Computing*, 9:291–312, 1988.
132. R. M. Karp. Reducibility among combinatorial problems. In *Complexity of Computer Computations*, pages 85–104. Plenum Press, New York, 1972.
133. T. I. Karush, N. K. Madsen, and G. H. Rodrigue. Matrix multiplication by diagonals on vector/parallel processors. Technical Report UCUD, Lawrence Livermore National Lab., Livermore, CA, 1975.
134. D. S. Kershaw. The incomplete Choleski conjugate gradient method for the iterative solution of systems of linear equations. *Journal of Computational Physics*, 26:43–65, 1978.
135. D. E. Keyes and W. D. Gropp. A comparison of domain decomposition techniques for elliptic partial differential equations and their parallel implementation. *SIAM Journal on Scientific and Statistical Computing*, 8(2):s166–s202, 1987.
136. D. E. Keyes, Y. Saad, and D. G. Truhlar. *Domain-Based Parallelism and Problem Decomposition Methods in Computational Science and Engineering*. SIAM, Philadelphia, PA, 1995. (Conference proceedings).
137. L. Yu. Kolotilina and A. Yu. Yeregin. On a family of two-level preconditionings of the incomplete block factorization type. *Soviet Journal of Numerical Analysis and Mathematical Modeling*, 1:293–320, 1986.
138. M. A. Krasnoselskii et al. *Approximate Solutions of Operator Equations*. Wolters-Nordhoff, Groningen, 1972.
139. V. Kumar, A. Grama, A. Gupta, and G. Kapyris. *Parallel Computing*. Benjamin Cummings, Redwood City, CA, 1994.
140. C. Lanczos. An iteration method for the solution of the eigenvalue problem of linear differential and integral operators. *Journal of Research of the National Bureau of Standards*, 45:255–282, 1950.
141. C. Lanczos. Chebyshev polynomials in the solution of large-scale linear systems. In *Proceedings of the ACM*, pages 124–133, 1952.
142. C. Lanczos. Solution of systems of linear equations by minimized iterations. *Journal of Research of the National Bureau of Standards*, 49:33–53, 1952.
143. P. LeTallec. Domain decomposition methods in computational mechanics. *Computational Mechanics Advances*, 1(2):121–220, 1994.
144. R. Leuze. Independent set orderings for parallel matrix factorizations by Gaussian elimination. *Parallel Computing*, 10:177–191, 1989.
145. J. G. Lewis, B. W. Peyton, and A. Pothen. A fast algorithm for reordering sparse matrices for parallel factorizations. *SIAM Journal on Scientific and Statistical Computing*, 6:1146–1173, 1989.
146. J. G. Lewis and H. D. Simon. The impact of hardware scatter-gather on sparse Gaussian elimination. *SIAM Journal on Scientific and Statistical Computing*, 9:304–311, 1988.

147. S. Ma. *Parallel block preconditioned Krylov subspace methods for Partial Differential Equations*. Ph.D. thesis, Department of Computer Science, Minneapolis, MN, 1993.
148. T. A. Manteuffel. An incomplete factorization technique for positive definite linear systems. *Mathematics of Computations*, 34:473–497, 1980.
149. J. A. Meijerink and H. A. van der Vorst. An iterative solution method for linear systems of which the coefficient matrix is a symmetric M-matrix. *Mathematics of Computations*, 31(137):148–162, 1977.
150. G. L. Miller, S. H. Teng, W. Thurston, and S. A. Vavasis. Automatic mesh partitioning. In A. George, J. Gilbert, and J. Liu, editors, *Sparse Matrix Computations: Graph Theory Issues and Algorithms*, 1993. IMA Volumes in Mathematics and Its Applications.
151. N. Munksgaard. Solving sparse symmetric sets of linear equations by preconditioned conjugate gradient method. *ACM Transactions on Mathematical Software*, 6:206–219, 1980.
152. N. M. Nachtigal. *A look-ahead variant of the Lanczos Algorithm and its application to the Quasi-Minimal Residual method for non-Hermitian linear systems*. Ph.D. thesis, Applied Mathematics, Cambridge, 1991.
153. J. Ortega. Efficient implementation of certain iterative methods. *SIAM Journal on Scientific and Statistical Computing*, 9:882–891, 1988.
154. J. Ortega. Orderings for conjugate gradient preconditionings. *SIAM Journal on Scientific and Statistical Computing*, 12:565–582, 1991.
155. J. M. Ortega. *Introduction to Parallel and Vector Solution of Linear Systems*. Plenum Press, New York, 1988.
156. J. M. Ortega and R. G. Voigt. Solution of partial differential equations on vector and parallel computers. *SIAM Review*, 27:149–240, 1985.
157. O. Osterby and Z. Zlatev. *Direct Methods for Sparse Matrices*. Springer Verlag, New York, 1983.
158. C. C. Paige. Computational variants of the Lanczos method for the eigenproblem. *Journal of the Institute of Mathematics and its Applications*, 10:373–381, 1972.
159. C. C. Paige and M. A. Saunders. Solution of sparse indefinite systems of linear equations. *SIAM Journal on Numerical Analysis*, 12:617–624, 1975.
160. B. N. Parlett. *The Symmetric Eigenvalue Problem*. Prentice Hall, Englewood Cliffs, 1980.
161. B. N. Parlett, D. R. Taylor, and Z. S. Liu. A look-ahead Lanczos algorithm for nonsymmetric matrices. *Mathematics of Computation*, 44:105–124, 1985.
162. D. Peaceman and H. Rachford. The numerical solution of elliptic and parabolic differential equations. *Journal of SIAM*, 3:28–41, 1955.
163. S. Pissanetzky. *Sparse Matrix Technology*. Academic Press, New York, 1984.
164. E. L. Poole and J. M. Ortega. Multicolor ICCG methods for vector computers. *SIAM Journal on Numerical Analysis*, 24:1394–1418, 1987.

165. A. Pothen, H. D. Simon, and K. P. Liou. Partitioning sparse matrices with eigenvectors of graphs. *SIAM Journal on Matrix Analysis and Applications*, 11:430–452, 1990.
166. J. S. Przemieniecki. Matrix structural analysis of substructures. *Am. Inst. Aero. Astro. J.*, 1:138–147, 1963.
167. J. K. Reid. On the method of conjugate gradients for the solution of large sparse systems of linear equations. In J. K. Reid, editor, *Large Sparse Sets of Linear Equations*, pages 231–254. Academic Press, 1971.
168. T. J. Rivlin. *The Chebyshev Polynomials: from Approximation Theory to Algebra and Number Theory*. J. Wiley and Sons, New York, 1990.
169. F. X. Roux. Acceleration of the outer conjugate gradient by reorthogonalization for a domain decomposition method for structural analysis problems. In Tony Chan and Roland Glowinski, editors, *Proceedings of the Third International Symposium on Domain Decomposition Methods, Houston March 20-22 1989*. SIAM, Philadelphia, PA, 1990.
170. A. Ruhe. Implementation aspects of band Lanczos algorithms for computation of eigenvalues of large sparse symmetric matrices. *Mathematics of Computations*, 33:680–687, 1979.
171. H. Rutishauser. Theory of gradient methods. In *Refined Iterative Methods for Computation of the Solution and the Eigenvalues of Self-Adjoint Boundary Value Problems*, pages 24–49. Institute of Applied Mathematics, Zurich, Birkhäuser Verlag, Basel-Stuttgart, 1959.
172. Y. Saad. Krylov subspace methods for solving large unsymmetric linear systems. *Mathematics of Computation*, 37:105–126, 1981.
173. Y. Saad. The Lanczos biorthogonalization algorithm and other oblique projection methods for solving large unsymmetric systems. *SIAM Journal on Numerical Analysis*, 19:470–484, 1982.
174. Y. Saad. Iterative solution of indefinite symmetric systems by methods using orthogonal polynomials over two disjoint intervals. *SIAM Journal on Numerical Analysis*, 20:784–811, 1983.
175. Y. Saad. Practical use of polynomial preconditionings for the conjugate gradient method. *SIAM Journal on Scientific and Statistical Computing*, 6:865–881, 1985.
176. Y. Saad. Least squares polynomials in the complex plane and their use for solving sparse nonsymmetric linear systems. *SIAM Journal on Numerical Analysis*, 24:155–169, 1987.
177. Y. Saad. On the Lanczos method for solving symmetric linear systems with several right-hand sides. *Mathematics of Computations*, 48:651–662, 1987.
178. Y. Saad. Krylov subspace methods on supercomputers. *SIAM Journal on Scientific and Statistical Computing*, 10:1200–1232, 1989.
179. Y. Saad. SPARSKIT: A basic tool kit for sparse matrix computations. Technical Report 90-20, Research Institute for Advanced Computer Science, NASA Ames Research Center, Moffet Field, CA, 1990.
180. Y. Saad. *Numerical Methods for Large Eigenvalue Problems*. Halstead Press, New York, 1992.

181. Y. Saad. A flexible inner-outer preconditioned GMRES algorithm. *SIAM Journal on Scientific and Statistical Computing*, 14:461–469, 1993.
182. Y. Saad. Highly parallel preconditioners for general sparse matrices. In G. Golub, M. Luskin, and A. Greenbaum, editors, *Recent Advances in Iterative Methods, IMA Volumes in Mathematics and Its Applications*, volume 60, pages 165–199. Springer Verlag, New York, 1994.
183. Y. Saad. ILUT: a dual threshold incomplete ILU factorization. *Numerical Linear Algebra with Applications*, 1:387–402, 1994.
184. Y. Saad. Analysis of augmented Krylov subspace techniques. *SIAM Journal on Matrix Analysis and Applications*, 18:435–449, 1997.
185. Y. Saad and M. H. Schultz. GMRES: a generalized minimal residual algorithm for solving nonsymmetric linear systems. *SIAM Journal on Scientific and Statistical Computing*, 7:856–869, 1986.
186. Y. Saad and M. H. Schultz. Parallel implementations of preconditioned conjugate gradient methods. In W. E. Fitzgibbon, editor, *Mathematical and Computational Methods in Seismic Exploration and Reservoir Modeling*. SIAM, Philadelphia, PA, 1986.
187. Y. Saad and K. Wu. DQGMRES: a direct quasi-minimal residual algorithm based on incomplete orthogonalization. *Numerical Linear Algebra with Applications*, 3:329–343, 1996.
188. H. Sadok. *Méthodes de projection pour les systèmes linéaires et non linéaires*. Ph.D. thesis, University of Lille 1, Lille, France, 1981.
189. J. Saltz, R. Mirchandaney, and K. Crowley. Run-time parallelization and scheduling of loops. *IEEE Transactions on Computers*, 40:603–612, 1991.
190. J. H. Saltz. Automated problem scheduling and reduction of synchronization delay effects. Technical Report 87-22, ICASE, Hampton, VA, 1987.
191. W. Schönauer. The efficient solution of large linear systems, resulting from the fdm for 3-d PDE's, on vector computers. In Proceedings of the 1-st International colloquium on vector and parallel computing in Scientific applications - Paris March 1983, 1983.
192. W. Schönauer. *Scientific Computing on Vector Computers*. North-Holland, New York, 1987.
193. H. A. Schwarz. *Gesammelte Mathematische Abhandlungen*, volume 2, pages 133–143. Springer Verlag, Berlin, Germany / Heidelberg, Germany / London, UK / etc., 1890. First published in *Vierteljahrsschrift der Naturforschenden Gesellschaft in Zürich*, volume 15, 1870, pp. 272–286.
194. F. Shakib. *Finite element analysis of the compressible Euler and Navier Stokes Equations*. Ph.D. thesis, Department of Aeronautics, Stanford, CA, 1989.
195. A. Sidi. Extrapolation vs. projection methods for linear systems of equations. *Journal of Computational and Applied Mathematics*, 22:71–88, 1988.
196. V. Simoncini and E. Gallopoulos. An iterative method for nonsymmetric systems with multiple right-hand sides. *SIAM Journal on Scientific Computing*, 16(4):917–933, July 1995.

197. V. Simoncini and E. Gallopoulos. Convergence properties of block GMRES and matrix polynomials. *Linear Algebra and its Applications*, To appear.
198. B. F. Smith. An optimal domain decomposition preconditioner for the finite element solution of linear elasticity problems. *SIAM Journal on Scientific and Statistical Computing*, 13:364–378, 1992.
199. D. A. Smith, W. F. Ford, and A. Sidi. Extrapolation methods for vector sequences. *SIAM review*, 29:199–233, 1987.
200. D. C. Smolarski and P. E. Saylor. An optimum iterative method for solving any linear system with a square matrix. *BIT*, 28:163–178, 1988.
201. P. Sonneveld. CGS, a fast Lanczos-type solver for nonsymmetric linear systems. *SIAM Journal on Scientific and Statistical Computing*, 10(1):36–52, 1989.
202. G. W. Stewart. *Introduction to Matrix Computations*. Academic Press, New York, 1973.
203. W. J. Stewart. *Introduction to the Numerical Solution of Markov Chains*. Princeton University Press, Princeton, NJ, 1994.
204. E. L. Stiefel. Kernel polynomials in linear algebra and their applications. *U. S. National Bureau of Standards, Applied Mathematics Series*, 49:1–24, 1958.
205. Patrick Le Tallec, Yann-Hervé De Roeck, and Marina Vidrascu. Domain-decomposition methods for large linearly elliptic three dimensional problems. *Journal of Computational and Applied Mathematics*, 34, 1991. Elsevier Science Publishers, Amsterdam.
206. D. Taylor. *Analysis of the look-ahead Lanczos algorithm*. Ph.D. thesis, Department of Computer Science, Berkeley, CA, 1983.
207. L. N. Trefethen. Approximation theory and numerical linear algebra. Technical Report Numerical Analysis Report 88-7, Massachusetts Institute of Technology, Cambridge, MA, 1988.
208. H. A. van der Vorst. The performance of FORTRAN implementations for preconditioned conjugate gradient methods on vector computers. *Parallel Computing*, 3:49–58, 1986.
209. H. A. van der Vorst. Large tridiagonal and block tridiagonal linear systems on vector and parallel computers. *Parallel Computing*, 5:303–311, 1987.
210. H. A. van der Vorst. Bi-CGSTAB: A fast and smoothly converging variant of Bi-CG for the solution of non-symmetric linear systems. *SIAM Journal on Scientific and Statistical Computing*, 12:631–644, 1992.
211. H. A. van der Vorst and C. Vuik. GMRESR: a family of nested GMRES methods. *Numerical Linear Algebra with Applications*, 1:369–386, 1994.
212. R. S. Varga. Factorizations and normalized iterative methods. In *Boundary Problems in Differential Equations*, pages 121–142. University of Wisconsin Press, Madison, WI, 1960.
213. R. S. Varga. *Matrix Iterative Analysis*. Prentice Hall, Englewood Cliffs, NJ, 1962.
214. V. Venkatakrishnan. Preconditioned Conjugate Gradient methods for the compressible Navier Stokes equations. *AIAA Journal*, 29:1092–1100, 1991.

215. V. Venkatakrishnan. Parallel implicit methods for aerodynamic applications on unstructured grids. In D. E. Keyes, Y. Saad, and D. G. Truhlar, editors, *Domain-Based Parallelism and Problem Decomposition Methods in Computational Science and Engineering*, pages 57–74. SIAM, Philadelphia, PA, 1995.
216. V. Venkatakrishnan and D. J. Mavriplis. Implicit solvers for unstructured meshes. *Journal of Computational Physics*, 105:83–91, 1993.
217. V. Venkatakrishnan, H. D. Simon, and T. J. Barth. A MIMD Implementation of a Parallel Euler Solver for Unstructured Grids. *The Journal of Supercomputing*, 6:117–137, 1992.
218. P. K. W. Vinsome. ORTHOMIN, an iterative method for solving sparse sets of simultaneous linear equations. In *Proceedings of the Fourth Symposium on Reservoir Simulation*, pages 149–159. Society of Petroleum Engineers of AIME, 1976.
219. V. V. Voevodin. The problem of a non-selfadjoint generalization of the conjugate gradient method has been closed. *USSR Computational Mathematics and Mathematical Physics*, 23:143–144, 1983.
220. E. L. Wachspress. *Iterative Solution of Elliptic Systems and Applications to the Neutron Equations of Reactor Physics*. Prentice Hall, Englewood Cliffs, NJ, 1966.
221. H. F. Walker. Implementation of the GMRES method using Householder transformations. *SIAM Journal on Scientific Computing*, 9:152–163, 1988.
222. X. Wang, K. Gallivan, and R. Bramley. CIMGS: An incomplete orthogonal factorization preconditioner. Technical Report 394, Indiana University at Bloomington, Bloomington, IN, 1993.
223. J. W. Watts III. A conjugate gradient truncated direct method for the iterative solution of the reservoir simulation pressure equation. *Society of Petroleum Engineers Journal*, 21:345–353, 1981.
224. R. Weiss. A theoretical overview of Krylov subspace methods. In W. Schönauer and R. Weiss, editors, *Special Issue on Iterative Methods for Linear Systems*, pages 33–56. Applied Numerical Methods, 1995.
225. O. Widlund. A Lanczos method for a class of non-symmetric systems of linear equations. *SIAM Journal on Numerical Analysis*, 15:801–812, 1978.
226. L. B. Wigton. Application of MACSYMA and sparse matrix technology to multi-element airfoil calculations. In *Proceedings of the AIAA-87 conference, Honolulu, Hawaii, June 9-11, 1987*, pages 444–457. AIAA, New York, 1987. Paper number AIAA-87-1142-CP.
227. J. H. Wilkinson. *The Algebraic Eigenvalue Problem*. Clarendon Press, Oxford, 1965.
228. O. Wing and J. W. Huang. A computation model of parallel solution of linear equations. *IEEE Transactions on Computers*, C-29:632–638, 1980.
229. C. H. Wu. A multicolor SOR method for the finite-element method. *Journal of Computational and Applied Mathematics*, 30:283–294, 1990.
230. J. Xu. Iterative methods by space decomposition and subspace correction. *SIAM Review*, 34:581–613, December 1992.

231. Q. Ye. A breakdown-free variation of the Lanczos algorithm. *Mathematics of Computations*, 62:179–207, 1994.
232. D. M. Young. *Iterative Solution of Large Linear Systems*. Academic Press, New York, 1971.
233. D. P. Young, R. G. Melvin, F. T. Johnson, J. E. Bussoletti, L. B. Wigton, and S. S. Samant. Application of sparse matrix solvers as effective preconditioners. *SIAM Journal on Scientific and Statistical Computing*, 10:1186–1199, 1989.
234. L. Zhou and H. F. Walker. Residual smoothing techniques for iterative methods. *SIAM Journal on Scientific Computing*, 15:297–312, 1994.
235. Z. Zlatev. Use of iterative refinement in the solution of sparse linear systems. *SIAM Journal on Numerical Analysis*, 19:381–399, 1982.



INDEX

A

additive projection procedure, 136
ADI, 116
 Peaceman-Rachford algorithm, 117
adjacency graph, 71
 of PDE matrices, 71
adjoint of a matrix, 7
algebraic multiplicity, 15
Alternating Direction Implicit, *see* ADI
angle between a vector and a subspace, 130
anisotropic medium, 47
approximate inverse preconditioners, 297
 column-oriented, 300
 global iteration, 298
 for improving a preconditioner, 308
approximate inverse techniques, 375
Arnoldi's method, 146–157
 basic algorithm, 146
 breakdown of, 148
 with Householder orthogonalization, 149
 for linear systems, 151
 lucky breakdown, 148
 with Modified Gram-Schmidt, 148
 practical implementation, 148
Arrow-Hurwicz's Algorithm, 241
assembled matrix, 60
assembly process, 59

B

banded matrices, 5
bandwidth
 of a bus, 327
 of a matrix, 5
basis of a subspace, 10
BCG, 209–213
 algorithm, 210
 transpose-free variants, 213–226
BICGSTAB, 216
Biconjugate Gradient, *see* BCG

bidiagonal matrices, 5
bilinear form, 56
biorthogonal bases, 35
biorthogonal vectors, 35, 205
biorthogonalization, 204
bipartite graph, 82, 112
block Arnoldi
 algorithm, 196
 Ruhe's variant, 197
block diagonal matrices, 5
block FOM, 199
block Gaussian elimination, 385–388
 algorithm, 388
block GMRES, 199–200
 multiple right-hand sides, 199
block Gram-Schmidt, 197
block Jacobi, 102
 as a preconditioner, 353
block Krylov subspace methods, 144, 196–200
block preconditioners, 309
block relaxation, 98
block tridiagonal matrices, 5, 309
 preconditioning, 309
boundary conditions, 45, 46
 Dirichlet, 46
 mixed, 46
 Neumann, 46

C

cache memory, 327
canonical form, 15
 Jordan, 16
 Schur, 17
Cauchy-Schwartz inequality, 6, 8
Cayley-Hamilton theorem, 144
cell-centered scheme, 64
cell-vertex scheme, 64
centered difference approximation, 48
centered difference formula, 48

- centerpoint, 415
 - CG algorithm, *see* Conjugate Gradient algorithm
 - CG for normal equations, 236, 237
 - CGNE, 237
 - algorithm, 238
 - optimality, 238
 - CGNR, 236
 - algorithm, 236
 - optimality, 236
 - CGS, 214–216
 - algorithm, 216
 - characteristic polynomial, 3
 - Chebyshev
 - acceleration, 358
 - Chebyshev polynomials, 186–192, 194, 356–364
 - complex, 188, 203
 - and ellipses, 188
 - optimality, 189–191
 - for preconditioning, 356
 - real, 187
 - Cimmino’s method, 233
 - circuit switching, 328
 - coarse-grain, 353
 - coefficient matrix, 95
 - coloring vertices, 81
 - column reordering, 74
 - Compressed Sparse Column storage, *see* CSC
 - Compressed Sparse Row storage, *see* CSR
 - Concus, Golub, and Widlund algorithm, 260
 - condition number, 40
 - for normal equation systems, 230
 - condition numbers and CG, 180
 - Conjugate Gradient algorithm, 174–181
 - algorithm, 178
 - alternative formulations, 178
 - convergence, 191, 192
 - derivation, 174, 177
 - eigenvalue estimates, 180
 - for the normal equations, 236
 - preconditioned, 244
 - Conjugate Gradient Squared, *see* CGS
 - Conjugate Residual algorithm, 181
 - consistent matrix norms, 8
 - consistent orderings, 112–116
 - control volume, 63
 - convection-diffusion equation, 47
 - convergence
 - factor, 105
 - general, 105
 - specific, 105
 - of GMRES, 193
 - of the Minimal Residual method, 135
 - rate, 105
 - of relaxation methods, 104
 - of Schwarz procedures, 402
 - COO storage scheme, 84
 - coordinate storage format, *see* COO
 - Courant characterization, 26
 - Craig’s method, 238
 - CRAY T3D, 329
 - CSC storage format, 85
 - matvecs in, 335
 - CSR storage format, 85, 272
 - matvecs in, 335
 - cut-edges, 416
 - Cuthill-McKee ordering, 77
- D**
- data coherence, 327
 - data-parallel, 326
 - defective eigenvalue, 15
 - derogatory, 15
 - determinant, 3
 - DIA storage format, 85, 338
 - matvecs in, 338
 - diagonal
 - compensation, 285
 - dominance, 108, 109
 - form of matrices, 16
 - matrices, 5
 - diagonal storage format, *see* DIA
 - diagonalizable matrix, 16
 - diagonally dominant matrix, 109
 - diagonally structured matrices, 85
 - diameter of a graph, 417
 - diameter of a triangle, 58
 - DIOM, 154–157, 175
 - algorithm, 156
 - direct IOM, *see* DIOM
 - direct sum of subspaces, 10, 33
 - directed graph, 71
 - Dirichlet boundary conditions, 45, 46
 - distributed
 - computing, 325
 - ILU, 372
 - memory, 328
 - sparse matrices, 341, 373
 - divergence of a vector, 46
 - divergence operator, 46

- domain decomposition
 - convergence, 402
 - and direct solution, 387
 - full matrix methods, 411
 - induced preconditioners, 407
 - Schur complement approaches, 406
 - Schwarz alternating procedure, 394
- domain sweep, 396
- double orthogonalization, 148
- double-stripping, 418
- DQGMRES, 168–172, 258
 - algorithm, 169
- E**
- EBE preconditioner, 376
- EBE regularization, 377
- edge in a graph, 71
- eigenspace, 10
- eigenvalues, 3
 - definition, 3
 - from CG iteration, 180
 - index, 16, 17
 - of an orthogonal projector, 37
- eigenvector, 3
 - left, 4
 - right, 4
- Eisenstat's implementation, 248, 263
- Eisenstat's trick, *see* Eisenstat's implementation
- Element-By-Element preconditioner, *see* EBE preconditioner
- ELL storage format, 86
 - matvecs in, 339
- Ell storage format, 339
- elliptic operators, 44
- Ellpack-Itpack storage format, *see* ELL storage format
- energy norm, 32, 236, 238
- error projection methods, 129
- Euclidean inner product, 6
- Euclidean norm, 7
- F**
- Faber-Manteuffel theorem, 184
- factored approximate inverse, 306
- fast solvers, 47, 383
- FGMRES, 255–258
 - algorithm, 256
- fictitious domain methods, 387
- Fiedler vector, 416
- field of values, 23
- fill-in elements, 275
- fine-grain algorithms, 353
- finite difference scheme, 47
 - for 1-D problems, 50
 - for 2-D problems, 54
 - for the Laplacean, 49
 - upwind schemes, 51
- finite element method, 44, 55
- finite volume method, 63
- flexible GMRES, *see* FGMRES
- flexible iteration, 255
- flux vector, 63
- FOM, 151
 - algorithm, 152
 - with restarting, 153
- Frobenius norm, 8
- frontal methods, 60, 376
- full matrix methods, 411–413
- Full Orthogonalization Method, *see* FOM
- G**
- Galerkin conditions, 124
- Gastinel's method, 139
- gather operation, 336
- Gauss-Seidel iteration, 95
 - backward, 97
 - for normal equations, 231
 - in parallel, 378
 - symmetric, 97
- Gaussian elimination, 60, 176, 269–273, 278, 282, 283, 285–287, 368, 369, 383
 - block, 385
 - frontal methods, 376
 - IKJ variant, 271
 - in IOM and DIOM, 156
 - in Lanczos process, 176
 - parallel, 409
 - parallelism in, 71
 - reordering in, 75
 - in skyline format, 295
 - sparse, 70
- GCR, 182–184
- Generalized Conjugate Residual, *see* GCR
- geometric multiplicity, 15
- Gershgorin discs, 110
- Gershgorin's theorem, 109
- global iteration, 298–300, 305
- global reduction operations, 332
- GMRES, 157–172, 184, 193–196
 - algorithm, 158
 - block algorithm, 199

breakdown, 163, 164
 convergence, 193
 flexible variant, 250, 255–258
 Householder version, 158
 lucky breakdown, 164
 parallel implementation, 331
 with polynomial preconditioning, 363
 practical implementation, 160
 relation with FOM, 164, 166
 with restarting, 167
 stagnation, 167
 truncated, 168
 grade of a vector, 144
 Gram-Schmidt algorithm, 11–12, 314
 block, 197
 cancellations in, 148
 modified, 11
 standard, 11
 graph, 71
 bipartite, 82
 coloring, 81, 403
 directed, 71
 edges, 71
 Laplacian of a , 416
 partitioning, 382, 413
 geometric, 414
 graph theory techniques, 417
 spectral techniques, 416
 type, 384
 undirected, 71
 vertices, 71

H

Hankel matrix, 208
 harmonic functions, 46
 Harwell-Boeing collection, 89, 90
 Hausdorff's convex hull theorem, 23
 heap-sort, in ILUT, 291
 Hermitian inner product, 6
 Hermitian matrices, 4, 24
 Hermitian Positive Definite, 31
 Hessenberg matrices, 5
 Hölder norms, 7
 Householder algorithm, 12
 Householder orthogonalization
 in Arnoldi's method, 149
 Householder reflectors, 12
 HPD, *see* Hermitian Positive Definite
 hypercube, 329

I

idempotent, 10, 33
 if and only if, 3
 iff, *see* if and only if
 ILQ
 factorization, 315
 preconditioning, 314
 ILU, 268–297
 distributed, 372
 factorization, 268
 instability in, 293, 297
 general algorithm, 270
 IKJ version, 272
 ILUS, 294–297
 algorithm, 296
 modified, 285–286
 preconditioner, 268
 for Schur complement, 409
 static pattern, 273
 with threshold, *see* ILUT and ILUTP
 with multi-elimination, *see* ILUM
 zero pattern, 270
 ILU(0), 265, 268, 274–276
 algorithm, 275
 distributed factorization, 374
 for distributed sparse matrices, 373
 for red-black ordering, 366
 ILU(1), 278
 ILUM, 370
 ILUT, 286–293
 algorithm, 287
 analysis, 288
 implementation, 290
 with pivoting, *see* ILUTP
 ILUTP, 293
 for normal equations, 312
 incomplete
 orthogonalization
 algorithm, 154
 incomplete factorization, 265, 268
 Gram-Schmidt, 315
 ILQ, 314, 315
 QR, 315
 incomplete Gram-Schmidt, 316
 Incomplete LQ, *see* ILQ
 Incomplete LU, *see* ILU
 Incomplete Orthogonalization Method, *see*
 IOM
 indefinite inner product, 207
 independent set orderings, 79
 independent sets, 79, 368
 maximal, 80

- index of an eigenvalue, 16, 17
- indirect addressing, 69
- induced norm, 8
- induced preconditioners, 407
- inhomogeneous medium, 47
- inner products, 5
 - indefinite, 207
- invariant subspace, 10, 130
- inverse LU factors, 306
- IOM, 154
 - algorithm, 154
 - direct version, 154
- irreducibility, 83
- irreducible, 27
- isometry, 7
- iteration matrix, 102, 104
- J**
- j-diagonal, 340
- Jacobi iteration, 95
 - for the normal equations, 233
- JAD storage format, 340
 - definition, 340
 - in level scheduling, 348
 - matvecs in, 341
- jagged diagonal format, *see* JAD storage format
- jagged diagonals, 340
- Jordan block, 17
- Jordan box, 17
- Jordan canonical form, 16
- Jordan submatrix, 17
- Joukowski mapping, 188
- K**
- kernel, 9, 10
- Krylov subspace, 144
 - dimension of a, 144
 - invariant, 145
 - methods, 143
- Krylov subspace methods, 204
- L**
- Lanczos algorithm, 172, 173
 - algorithm, 173, 205
 - biorthogonalization, 204
 - breakdown, 206
 - incurable, 207
 - lucky, 207
 - serious, 207
 - for linear systems, 208
 - look-ahead version, 207
 - loss of orthogonality, 173
 - modified Gram-Schmidt version, 173
 - nonsymmetric, 204
 - and orthogonal polynomials, 173
 - partial reorthogonalization, 173
 - practical implementations, 207
 - selective reorthogonalization, 173
 - symmetric case, 172
- Laplacean, *see* Laplacean operator
- Laplacean operator, 46, 55
 - of a graph, 416
- least-squares polynomials, 359
- least-squares problem, 229
- left eigenvector, 4
- left versus right preconditioning, 255
- level of fill-in, 278
- level scheduling, 345–348
 - for 5-point matrices, 345
 - for general matrices, 346
- level set orderings, 76, 417
- line relaxation, 99
- linear mappings, 2
- linear span, 9
- linear system, 38, 95
 - existence of a solution, 38
 - right-hand side of a, 38
 - singular, 38
 - unknown of a, 38
- linked lists, 88
- local Schur complement, 393
- Look-ahead Lanczos algorithm, 207
- lower triangular matrices, 5
- LQ factorization, 314
 - algorithm, 315
- lucky breakdowns, 148
- M**
- mask, 320
- matrix, 1
 - addition, 2
 - adjoint of a, 7
 - banded, 5
 - bidiagonal, 5
 - canonical forms, 15
 - characteristic polynomial, 3
 - diagonal, 5
 - diagonal dominant, 108
 - diagonal form, 16
 - diagonalizable, 16
 - Hermitian, 4, 21, 24

- Hessenberg, 5
 - irreducible, 83
 - Jordan canonical form, 16
 - multiplication, 2
 - nonnegative, 4, 26
 - nonsingular, 3
 - norm of a , 8
 - normal, 4, 21
 - orthogonal, 5
 - outer product, 5
 - positive definite, 30–32
 - powers of a , 19
 - reduction, 15
 - Schur form, 17
 - self-adjoint, 7, 403
 - singular, 3
 - skew-Hermitian, 4
 - skew-symmetric, 4
 - spectral radius, 4
 - spectrum, 3
 - square, 3
 - symmetric, 4
 - Symmetric Positive Definite, 31, 112
 - trace, 4
 - transpose, 2
 - transpose conjugate, 2
 - triangular, 5
 - tridiagonal, 5
 - unitary, 4
 - matrix-by-vector product, 334
 - dense matrices, 334
 - for distributed matrices, 344
 - in DIA format, 338
 - in Ellpack format, 339
 - in triad form, 339
 - mesh generation, 61
 - mesh size, 58
 - message passing, 328
 - MILU, 285–286
 - minimal degree ordering, 88
 - Minimal Residual iteration, 133
 - algorithm, 134
 - convergence, 135
 - min-max theorem, 24
 - mixed boundary conditions, 45, 46
 - M -matrix, 26, 269, 310
 - modified Gram-Schmidt, 148
 - Modified ILU, *see* MILU
 - Modified Sparse Row storage, *see* MSR
 - molecule, 48
 - moment matrix, 208
 - in Lanczos procedure, 208
 - MR iteration, *see* Minimal Residual iteration
 - MSR storage format, 85
 - multi-elimination, 368, 369
 - multicolor orderings, 81
 - multicoloring, 364–368
 - for general sparse matrices, 367
 - multifrontal methods, 381
 - multinode expansion algorithm, 420
 - multiple eigenvalue, 15
 - multiple vector pipelines, 325
 - multiplicative projection process, 138
 - multiplicative Schwarz preconditioning, 399
 - multiprocessing, 325
- N**
- natural ordering, 54
 - near singularity, 40
 - nested-dissection ordering, 88
 - Neumann boundary conditions, 45, 46
 - Neumann polynomials, 355
 - nonnegative matrix, 4, 26
 - nonsingular matrix, 3
 - norm
 - Euclidean, 7
 - Hölder, 7
 - induced, 8
 - of matrices, 8
 - p -norm, 8
 - of vectors, 5
 - normal derivative, 56
 - normal equations, 229
 - normal matrix, 4, 21
 - null space, 9, 10
 - of a projector, 33
- O**
- Object Oriented Programming, 334
 - oblique projection methods, 204
 - oblique projector, 35
 - operator
 - elliptic, 44
 - Laplacean, 46
 - optimality of projection methods, 126
 - order relation for matrices, 26
 - ORTHODIR, 182–184
 - orthogonal
 - complement, 10
 - matrix, 5
 - projector, 10, 35
 - vectors, 10

- orthogonality, 10
 - between vectors, 10
 - of a vector to a subspace, 10
- ORTHOMIN, 182–184
- orthonormal, 10
- outer product matrices, 5
- overdetermined systems, 229
- overlapping domains, 385
- over-relaxation, 97
- P**
- p-norm, 8
- packet switching, 328
- parallel architectures, 326
- parallel sparse techniques, 72
- parallelism, 324
 - forms of, 324
- partial differential equations, 44
- partial Schur decomposition, 18
- partition, 100
- partition vector, 416
- partitioning, 384
- PDE, *see* partial differential equations
- PE, *see* Processing Element
- Peaceman-Rachford algorithm, 117
- peripheral node, 417
- permutation matrices, 5, 73
- permutations, 72
- Perron-Frobenius theorem, 27
- perturbation analysis, 39
- Petrov-Galerkin conditions, 122–124
- physical mesh versus graph, 72
- pipelining, 324
- polynomial approximation, 144
- polynomial preconditioning, 352, 354–364
- positive definite matrix, 6, 25, 30–32
- positive matrix, 26
- positive real matrix, *see* positive definite matrix
- positive semidefinite, 25
- preconditioned
 - CG, 244
 - efficient implementations, 248
 - left, 246
 - for the normal equations, 259
 - parallel implementation, 330
 - split, 247
 - symmetry in, 245
 - fixed-point iteration, 103
 - GMRES, 250
 - comparison, 253
 - flexible variant, 255, 256
 - left preconditioning, 250
 - right preconditioning, 252
 - split preconditioning, 253
- preconditioner, 103
- preconditioning, 102, 244
 - EBE, 376
 - incomplete LU, 268
 - induced, 407
 - Jacobi, 265
 - normalequationsfor normal equations, 311
 - polynomial, 354–364
 - with Chebyshev polynomials, 356
 - with least-squares polynomials, 359
 - with Neumann polynomials, 355
 - and relaxation scheme, 103
 - SOR, 265
 - SSOR, 265
- probing, 409
- Processing Element (PE), 325
- profile, 79
- projection
 - operator, *see* projector
 - orthogonal to, 33
 - parallel to, 33
- projection methods, 122
 - additive, 136
 - approximate problem, 123
 - definitions, 122
 - error bounds, 129
 - general, 123
 - matrix representation, 124
 - multiplicative, 138
 - oblique, 122, 204
 - one-dimensional, 131
 - optimality, 126
 - orthogonal, 122, 124
 - prototype, 124
 - residual, 127
 - theory, 126
- projector, 10, 32–38, 101
 - existence, 34
 - matrix representation, 35
 - oblique, 35
 - orthogonal, 35
 - eigenvalues, 37
 - properties, 37
- prolongation operator, 101, 398
- property A, 112
- pseudo-peripheral node, 417

Q

QMR, 209–213
 algorithm, 212
 approximation, 212
 QR decomposition, 11
 Quasi-GMRES, 168
 algorithm, 168
 Quasi-Minimal Residual, *see* QMR
 quasi-Schur form, 18
 quick-split, in ILUT, 291
 quotient graph, 72

R

range, 2, 9, 10
 of a projector, 33
 rank, 10
 full, 10
 Rayleigh quotient, 23, 24
 real Schur form, 18
 recursive graph bisection, 418
 red-black ordering, 364
 reduced system, 318, 387
 reducible, 27
 reduction of matrices, 15
 reduction operations, 332
 reflectors, 12
 regular splitting, 107
 regularization, 241
 relaxation methods
 block, 98
 convergence, 104
 reordering, 74
 reordering rows, columns, 72
 reorthogonalization, 11
 residual norm steepest descent, 135
 residual projection methods, 127
 restarted FOM, 153
 restriction operator, 101, 397
 reverse communication, 333
 right versus left preconditioning, 255
 right-hand side, 38, 95
 multiple, 199
 row projection methods, 231, 378
 parallel, 378
 row reordering, 74
 row sum, 285

S

saddle-point problems, 238
 SAXPY, 131, 301, 332
 parallel, 332

sparse, 301
 scatter and gather operations, 336–337
 Schur complement, 387
 approaches, 406
 and direct solution, 387
 for finite-element partitionings, 392
 local, 391
 methods, 407
 properties, 388
 for vertex partitionings, 389
 Schur form, 17
 example, 18
 nonuniqueness, 19
 partial, 18
 quasi, 18
 real, 18
 Schwarz alternating procedure, 385, 394
 additive, 401
 algorithm, 395
 multiplicative, 394
 search subspace, 122
 section of an operator, 145
 self preconditioning, 301
 convergence behavior, 303
 self-adjoint, 7, 403
 semisimple, 15
 separators, 414
 set decomposition, 100
 shared memory computers, 326
 similarity transformation, 15
 simple eigenvalue, 15
 singular matrix, 3
 singular values, 9
 sites (in graph partitioning), 420
 skew-Hermitian
 matrices, 4, 21, 186
 part, 31
 skew-symmetric matrices, 4
 skyline solvers, 79
 SOR, 97
 convergence, 112
 iteration, 95
 multicolor sweep, 368
 for SPD matrices, 112
 span of q vectors, 9
 sparse, 59
 sparse Gaussian elimination, 70, 88
 sparse matrices
 adjacency graph, 70, 71
 basic operations, 86
 direct methods, 88

- graph representation, 70
- matrix-by-vector operation, 87
- permutation and reordering, 72
- storage, 83–86
- sparse matrix-by-vector product, 87
- sparse skyline storage format, *see* SSK
- sparse triangular system solution, 87
- sparse-sparse mode computations, 300
- sparsity, 68
- SPARSKIT, 89–91
- SPD, *see* Symmetric Positive Definite
- spectral bisection, 416
- spectral radius, 4
- spectrum of a matrix, 3
- splitting, 97
- square matrices, 3
- SSK storage format, 295
- SSOR, 97
- steepest descent, 131
- stencil, 48
- stereographic projection, 415
- Stieljes algorithm, 174
- stiffness matrix, 59, 61
- Stokes problem, 240
- storage format
 - COO, 84
 - CSC, 85
 - CSR, 85, 272
 - ELL, 86
 - MSR, 85
 - SSK, 295
- storage of sparse matrices, 83–86
- structured sparse matrix, 69
- subdomain, 373
- subspace, 9
 - direct sum, 10
 - of approximants, 122
 - of constraints, 122
 - orthogonal, 10
 - sum, 10
- Successive Over-Relaxation, *see* SOR
- symbolic factorization, 88
- symmetric Gauss Seidel, 97
- symmetric matrices, 4
- Symmetric Positive Definite, 31, 112
- Symmetric SOR, *see* SSOR
- symmetric squaring, 315
- symmetry in preconditioned CG, 245

T

- test problems, 88
- TFQMR, 219
 - algorithm, 224
- topological sorting, 346
- trace, 4
- Transpose-Free QMR, *see* TFQMR
- triad operation, 339
- triangular systems, 344
 - distributed, 375
 - level scheduling, 346
 - sparse, 344
- tridiagonal matrices, 5

U

- unassembled matrix, 60
- under-determined, 230
- undirected graph, 71
- unitary matrices, 4
- unstructured sparse matrix, 69
- upper triangular matrices, 5
- upwind schemes, 51
- Uzawa's algorithm, 239

V

- variable preconditioner, 255
- vector
 - computers, 325
 - operations, 331
 - orthogonality, 10
 - processors, 325
 - of unknowns, 95
 - updates, 131, 332
 - parallel, 332
- vertex (in a graph), 71

W

- wavefronts, 346
- weak formulation, 56
- weakly diagonally dominant matrix, 109
- Winget regularization, 377

Z

- Zarantonello's lemma, 189